



THE LIGHT-WEIGHT
LINE WITH
HEAVY-DUTY
FEATURES

FLAIRLINE HEAVY-DUTY CYLINDER FEATURES	3	MOUNTING STYLES	9
DOUBLE-ACTING NFPA CYLINDERS		ROD END STYLES	9
Series T, TS, TL and TLS	4	ACCESSORIES	10
DOUBLE-ACTING DOUBLE-ENDED NFPA CYLINDERS		MAGNETIC SWITCH OPTIONS	
Series TDE and TSDE	4	Series TM, TSM, TMDE and TSMDE	11
MAGNETIC SWITCH DOUBLE-ACTING NFPA CYLINDERS		ENGINEERING DATA	12
Series TM and TSM	5	FLUID POWER FORMULAS	12
MAGNETIC SWITCH DOUBLE-ACTING DOUBLE-ENDED NFPA CYLINDERS		ROD DIAMETER SELECTION	13
Series TMDE and TSMDE	5	STOP TUBE SELECTION	13
DIMENSIONAL DATA		SPECIAL OPTIONS	14
NFPA MXO (Without Mounts)	6	ORDERING INSTRUCTIONS	15
MOUNTING STYLES	7		
MOUNTING STYLES	8		

FLAIRLINE® HEAVY-DUTY NFPA CYLINDERS

A FLAIR FOR RELIABILITY, AVAILABILITY,
ECONOMY AND SERVICE

Flairline Means Value

You can select Flairline products with confidence. They are expertly designed, made of the finest materials available, and carefully assembled. Our design specifications are precisely held during manufacture, and every individual product must pass stringent functional tests before they are considered "customer ready."

*After testing is completed, **Flairline/Fast shipping** assures that Flairline products are shipped to our distributors or directly to the customers within three to five working days. Flairline understands that availability is important.*

So is price. Flairline products are surprisingly inexpensive, rapidly repaying your low initial investment with trouble-free operation. Quality design and easy repairability enhance production and add value to your equipment.

Should Flairline products need service, we provide that too. Our interest in your complete satisfaction doesn't end after the sale. With repair kits and parts, Flairline is prepared to

handle any emergency and minimize downtime. Make your selections with complete confidence from our extensive line of low cost, fast-action pneumatic or hydraulic actuators.

Special Products

Flairline standard products offer a wide variety of application capabilities. No matter how extensive a product line may be, there is often a need for something unique for your special application. Responding to this need is important to Flairline. We are pleased to offer our capabilities to manufacture pneumatic and hydraulic actuators to your specifications. Contact your local Flairline distributor for more information.

CAD Files

*CAD product drawings are available in all formats for use with this catalog. These drawings can also be downloaded from our Web site at **www.flairline.com***

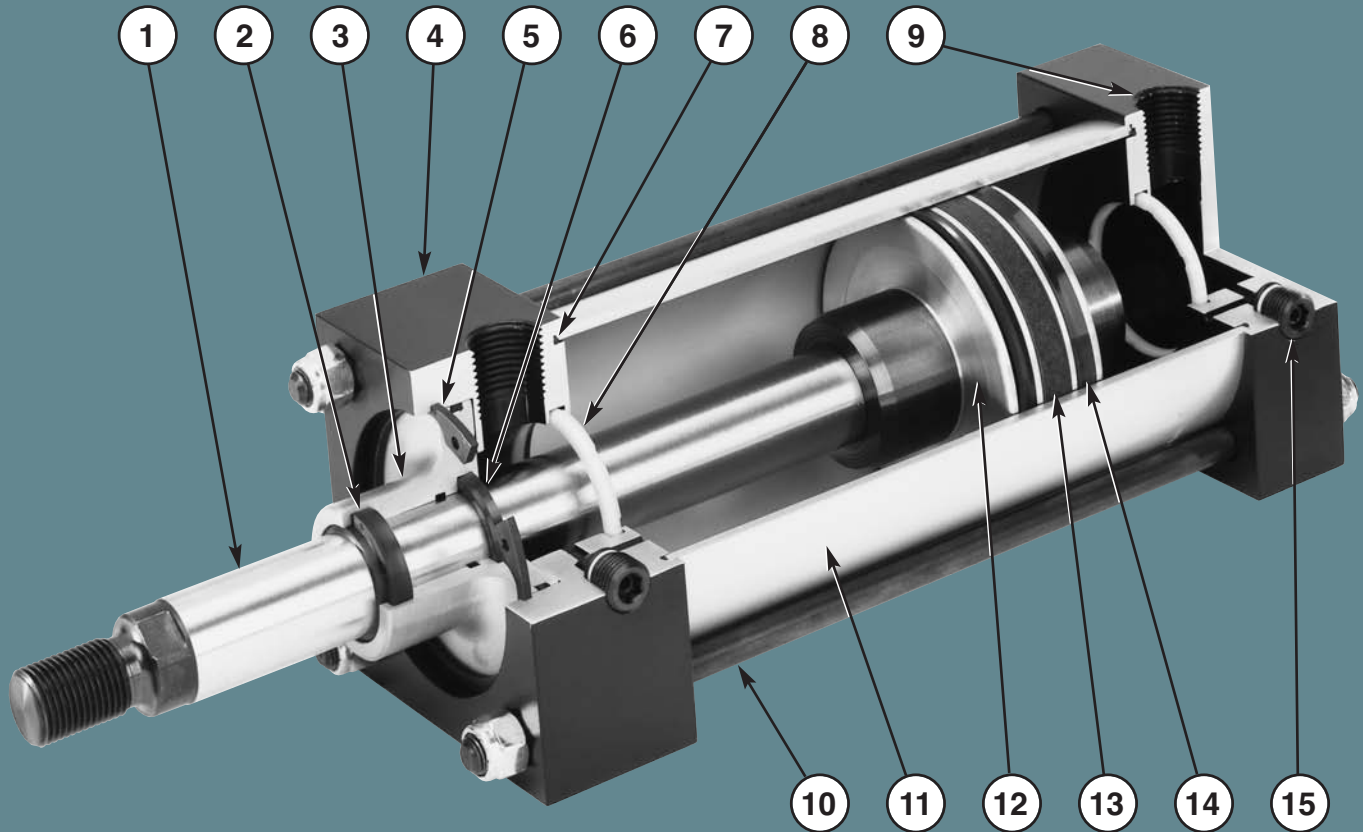

1. Chrome plated, high strength, steel **PISTON ROD** is corrosion resistant, rugged and durable.

2. Urethane, double lip **ROD WIPER** aggressively wipes contaminants from rod protecting rod seal and cylinder.

3. 660 bronze **ROD BEARING** provides maximum rod support and low friction for normal to high-load conditions. Lube reservoir allows longer bearing and seal life without maintenance.

4. **HEAD** and **CAP** are machined, aluminum precision blocks for accurate mounting surfaces. Black anodized for corrosion resistance.

5. Steel **RETAINING RING** for strength, coated for corrosion resistance, allows easy removal of rod bearing and seals without disassembly of cylinder.

6. Pressure-energized, wear compensating, U-cup **ROD SEAL** provides positive sealing.

7. **BARREL SEALS** offer O-ring design for positive sealing.

8. Floating **CUSHION SEAL** "check valve" offers fast break-a-way, self-aligning, positive cushioning for faster cycle time and reduced cylinder wear.

9. N.P.T.F. **PORTS** standard.

10. **TIE RODS** are pre-stressed, high strength steel for maximum fatigue capacity and have rolled threads for added strength. Black oxide finish provides corrosion resistance.

11. Precision-drawn, light weight aluminum **BARREL** is hard anodized inside and out for corrosion and abrasion resistance. Fine I.D. micro-finish provides long life and positive sealing.

12. Aluminum **PISTON** is threaded to rod, permanently locked with aerobic adhesive and secured with lock nut. Optional magnet is installed under wear ring.

13. Specially formulated Acetal **WEAR RING** increases cylinder life by eliminating metal to metal contact.

14. Pressure-energized, wear compensating, U-cup **PISTON SEALS** provide positive sealing.

15. Adjustable **CUSHION NEEDLES** have fine thread metering, are captive and flush (cushions not available on head-end of 1 1/2 bore cylinders with oversize rods).

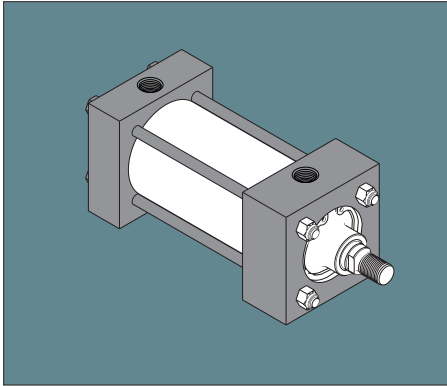

Flairline double-acting NFPA cylinders can be used in nearly all types of applications where economical, long-service actuators are required. Operating systems can be pneumatic or hydraulic. Precision components and sealing elements permit continuous operation in almost all environments. SERIES TS FEATURES OVERSIZED RODS. See page 6 for dimensional data; pages 7, 8 and 9 for mounting styles; page 9 for rod end styles; and page 10 for accessories. For special options, see page 14.

For ordering information, see page 15.

T TYPE PISTON

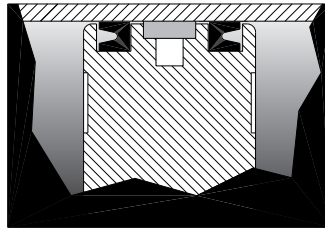

T/TS

*Standard Bore Sizes – 1½ to 8
Stock Stroke Sizes – 1" to 18" (1" increments)
Cushions available – either/both ends
Pneumatic – 250 psi. max.
Hydraulic – 400 psi. max. (non-shock)*

Pressure energized, wear compensating, U-cup piston seals (Buna N standard; Viton available). A specially formulated acetal wear ring prevents metal to metal contact.

TL/TLS

Flairline double acting cylinders can also be supplied with low running friction characteristics. They are built following NFPA standards and incorporate a custom piston and special seal configuration. Series TLS features oversized rods.

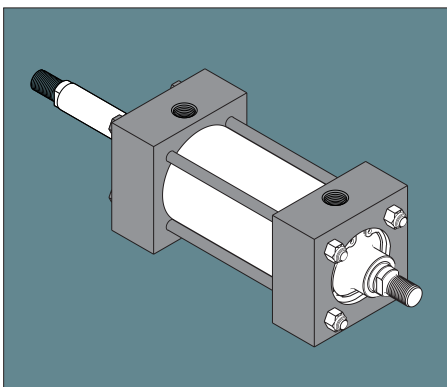

Flairline double-acting double-ended NFPA cylinders feature piston rod extensions from each end and include Flairline T type pistons. As one end is extended, the opposite end is retracted. Working range (stroke), force and speed are equal in both directions so work can be accomplished at both ends simultaneously. SERIES TSDE FEATURES OVERSIZED RODS. See page 6 for dimensional data; pages 7, 8 and 9 for mounting styles; page 9 for rod end styles; and page 10 for accessories. For special options, see page 14.

For ordering information, see page 15.

TDE/TSDE

*Standard Bore Sizes – 1½ to 8
Stock Stroke Sizes – 1" to 18" (1" increments)
Cushions available – either/both ends
Pneumatic – 250 psi. max.
Hydraulic – 400 psi. max. (non-shock)*

MAGNETIC SWITCH DOUBLE-ACTING NFPA CYLINDERS

FLAIRLINE HEAVY-DUTY

SERIES TM AND TSM

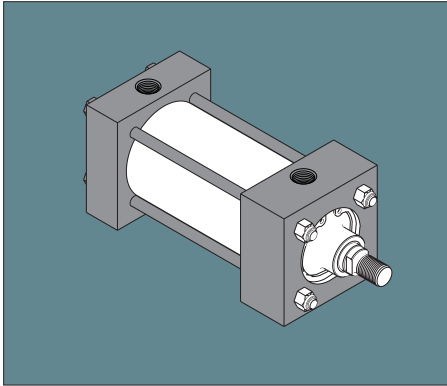

Flairline magnetic switch double-acting NFPA cylinders include TM type pistons with factory installed magnets for automated stroke sequencing. Magnetic switch options include Reed and Hall effect types. Tie rod mounted brackets can be adjusted to any location on the cylinder allowing several switches to be mounted for controlling or initiating any sequence function. SERIES TSM FEATURES OVERSIZED RODS. See page 6 for dimensional data; pages 7, 8 and 9 for mounting styles; page 9 for rod end styles; and page 10 for accessories. For Magnetic Switch options, see page 11; for special options, see page 14.

For ordering information, see page 15.

TM TYPE PISTON

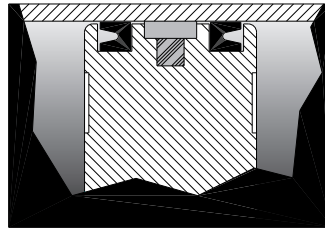

TM/TSM

Standard Bore Sizes – 1½ to 8
Stock Stroke Sizes – 1" to 18" (1" increments)
Cushions available – either/both ends
Pneumatic – 250 psi. max.
Hydraulic – 400 psi. max. (non-shock)

Pressure energized, wear compensating, U-cup piston seals (Buna N standard; Viton available), piston includes magnet. A specially formulated acetal wear ring prevents metal to metal contact.

MAGNETIC SWITCH DOUBLE-ACTING DOUBLE-ENDED NFPA CYLINDERS

FLAIRLINE HEAVY-DUTY

SERIES TMDE AND TSMDE

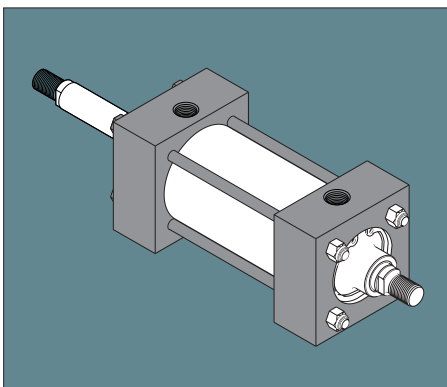

Flairline magnetic switch double-acting double-ended NFPA cylinders feature piston rod extensions from each end. As one end is extended, the opposite end is retracted. Working range (stroke), force and speed are equal in both directions so work can be accomplished at both ends simultaneously. Included are Flairline TM type pistons with factory installed magnets for automated stroke sequencing. Magnetic switch options include Reed and Hall effect types. Tie rod mounted brackets can be adjusted to any location on the cylinder allowing several switches to be mounted for controlling or initiating any sequence function. SERIES TSMDE FEATURES OVERSIZED RODS. See page 6 for dimensional data; pages 7, 8 and 9 for mounting styles; page 9 for rod end styles; and page 10 for accessories. For Magnetic Switch options, see page 11; for special options, see page 14.

For ordering information, see page 15.

TMDE/TSMDE

Standard Bore Sizes – 1½ to 8
Stock Stroke Sizes – 1" to 18" (1" increments)
Cushions available – either/both ends
Pneumatic – 250 psi. max.
Hydraulic – 400 psi. max. (non-shock)

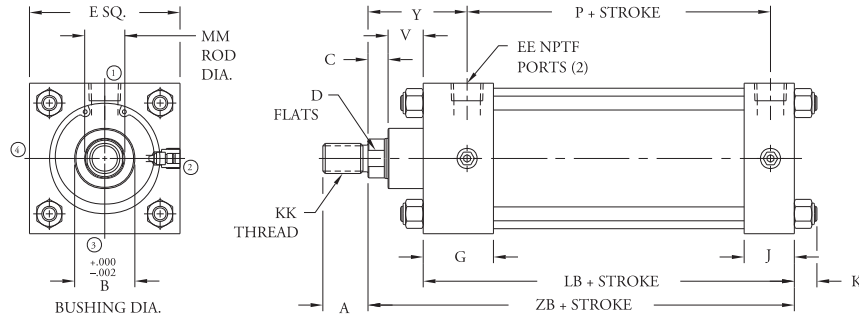

SERIES T/TM/TL SERIES TS/TSM/TLS (oversized rod)

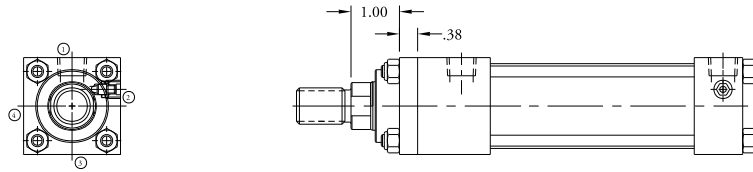

SERIES TS/TSM/TLS (1 1/2 BORE oversized rod)

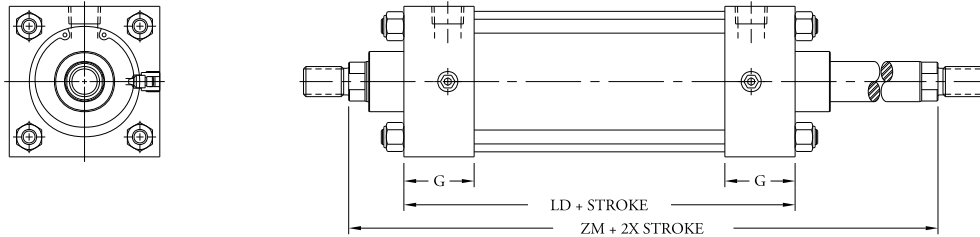

SERIES TDE/TMDE SERIES TSDE/TSMDE (oversized rod)

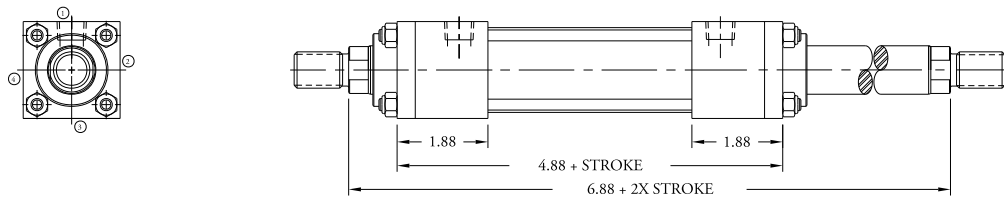

SERIES TSDE/TSMDE (1 1/2 BORE oversized rod)

DIMENSION REFERENCE	CYLINDER BORE								DIMENSION REFERENCE	CYLINDER BORE																							
	1 1/2	2	2 1/2	3 1/4	4	5	6	8		1 1/2	2	2 1/2	3 1/4	4	5	6	8																
A	3/4	1 1/8	3/4	1 1/8	3/4	1 1/8	1 1/8	1 5/8	1 1/8	1 5/8	1 1/8	1 5/8	1 1/8	1 5/8	2	1 5/8	2	LB	3 5/8	3 5/8	3 3/4	4 1/4	4 1/4	4 1/2	5	5 1/8							
B	1.124	1.499	1.124	1.499	1.124	1.499	1.499	1.999	1.499	1.999	1.499	1.999	1.999	2.374	1.999	2.374	LD	4 1/8	4 1/8	4 1/4	4 3/4	4 3/4	5	5 1/2	5 5/8								
C	3/8	1/2	3/8	1/2	3/8	1/2	1/2	5/8	1/2	5/8	1/2	5/8	5/8	3/4	5/8	3/4	MM (Rod Dia.)	5/8	1	5/8	1	5/8	1	1	1 1/8	1	1 3/8	1	1 3/8	1 3/8	1 3/4	1 3/8	1 3/4
D	1 1/2	7/8	1 1/2	7/8	1 1/2	7/8	7/8	1 1/32	7/8	1 1/32	7/8	1 1/32	1 1/8	1 1/2	1 1/8	1 1/2	P	2 5/16	2 5/16	2 7/16	2 9/16	2 9/16	2 13/16	3 3/16	3 5/16								
E	2	2 1/2	3	3 3/4	4 1/2	5 1/2	6 1/2	8 1/2	V	5/8	7/8	5/8	7/8	5/8	7/8	7/8	1	7/8	1	7/8	1	7/8	1	1	1 1/8	1	1 1/8						
EE	1/4*	1/4*	1/4*	1/2	1/2	1/2	3/4	3/4	Y	1 29/32	2 9/32	1 29/32	2 9/32	1 29/32	2 9/32	2 15/32	2 23/32	2 15/32	2 23/32	2 15/32	2 23/32	2 15/32	2 23/32	2 15/32	2 23/32	2 15/32	2 23/32	2 15/32	2 23/32	2 15/32	2 23/32		
G	1 1/2	1 1/2	1 1/2	1 3/4	1 3/4	1 3/4	2	2	ZB	4 5/8	5	4 5/8	5	4 3/4	5 1/8	5 3/8	5 7/8	5 3/8	5 7/8	5 3/8	5 7/8	5 7/8	6 1/8	6 3/8	6 7/8	6 3/4	7						
J	1	1	1	1 1/4	1 1/4	1 1/4	1 1/2	1 1/2	ZM	6 1/8	6 7/8	6 1/8	6 7/8	6 1/4	7	7 1/2	8	7 1/2	8	7 3/4	8 1/4	8 3/4	9 1/4	8 7/8	9 3/8								
K	7/16	15/32	15/32	9/16	9/16	3/4	3/4	7/8																									
KK	7/16-20	3/4-16	7/16-20	3/4-16	7/16-20	3/4-16	3/4-16	1-14	3/4-16	1-14	3/4-16	1-14	1-14	1 1/4-32	1-14	1 1/4-32																	

*3/8" ports optional on 1 1/2", 2" and 2 1/2" bore cylinders.

MOUNTING STYLES

FLAIRLINE HEAVY-DUTY

NFPA CYLINDERS

FRONT FLANGE MOUNT (NFPA MF1)

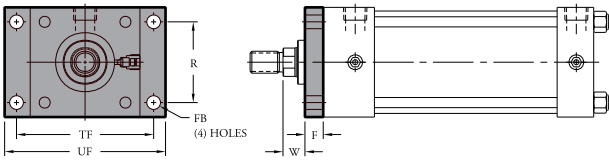

REAR FLANGE MOUNT (NFPA MF2)

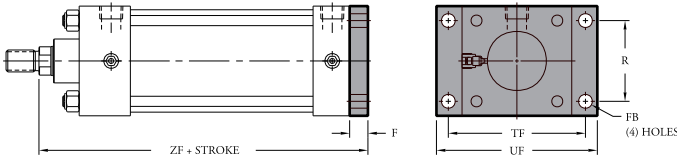

FRONT FACE MOUNT (FC1)

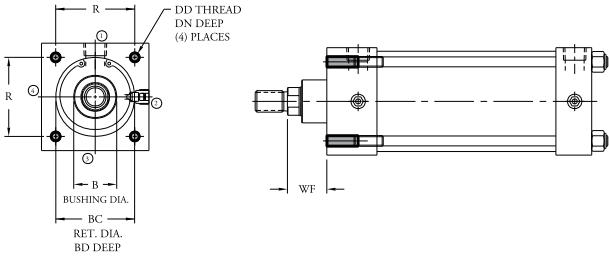

REAR FACE MOUNT (FC2)

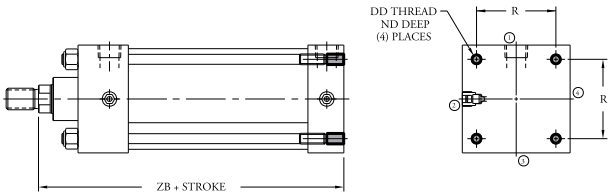

ANGLE MOUNTS (NFPA MS1)

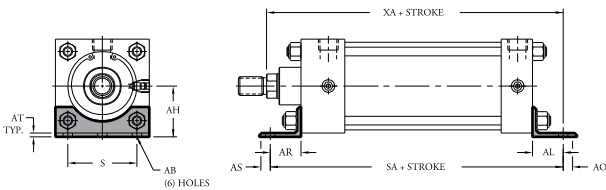

SIDE LUG MOUNTS (NFPA MS2)

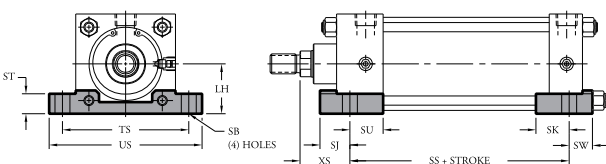

NFPA MF1 AND MF2

DIMENSION	CYLINDER BORE							
	1 1/2	2	2 1/2	3 1/4	4	5	6	
ROD DIA.	5/8 1	5/8 1	5/8 1	1 1 3/8	1 1 3/8	1 1 3/8	1 3/8 1 3/4	1 3/8 1 3/4
F	3/8	3/8	3/8	5/8	5/8	5/8	3/4	
FB	5/16	3/8	3/8	7/16	7/16	9/16	9/16	
R	1.43	1.84	2.19	2.76	3.32	4.10	4.88	
TF	2 3/4	3 3/8	3 7/8	4 11/16	5 7/16	6 5/8	7 5/8	
UF	3 3/8	4 1/8	4 5/8	5 1/2	6 1/4	7 5/8	8 5/8	
W	5/8 1	5/8 1	5/8 1	3/4 1	3/4 1	3/4 1	7/8 1 1/8	
ZF	5 5 3/8	5 5 3/8	5 5 3/8	5 1/2 6 1/4	6 1/2 6 1/4	6 1/2 6 3/4	7 3/8 7 5/8	

FC1

DIMENSION	CYLINDER BORE								
	1 1/2	2	2 1/2	3 1/4	4	5	6	8	
ROD DIA.	5/8 1	5/8 1	5/8 1	1 1 3/8	1 1 3/8	1 1 3/8	1 3/8 1 3/4	1 3/8 1 3/4	1 3/8 1 3/4
B	1.124 1.499	1.124 1.499	1.124 1.499	1.499 1.999	1.499 1.999	1.499 1.999	1.999 2.374	1.999 2.374	1.999 2.374
BC	1 5/8 N/A	2 1/8	2 1/8	2 3/4	2 3/4	2 3/4	3 1/4	3 1/4	
BD	1 1/16	3/32	3/32	5/32	5/32	5/32	3/16	3/16	
DD	1 1/4-28	5/16-24	5/16-24	3/8-24	3/8-24	1/2-20	1/2-20	5/8-18	
DN	3/4 1 1/8	3/4	3/4	7/8	7/8	7/8	1	1	
R	1.43	1.84	2.19	2.76	3.32	4.10	4.88	6.44	
WF	1 1	1 1 1/8	1 1 1/8	1 3/8 1 5/8	1 3/8 1 5/8	1 3/8 1 5/8	1 5/8 1 7/8	1 5/8 1 7/8	

*Includes 3/8 unthreaded cover plate

FC2

DIMENSION	CYLINDER BORE								
	1 1/2	2	2 1/2	3 1/4	4	5	6	8	
ROD DIA.	5/8 1	5/8 1	5/8 1	1 1 3/8	1 1 3/8	1 1 3/8	1 3/8 1 3/4	1 3/8 1 3/4	1 3/8 1 3/4
DD	1 1/4-28	5/16-24	5/16-24	3/8-24	3/8-24	1/2-20	1/2-20	5/8-18	
ND	1/2	1/2	1/2	5/8	5/8	5/8	3/4	3/4	
R	1.43	1.84	2.19	2.76	3.32	4.10	4.88	6.44	
ZB	4 5/8 5	4 5/8 5	4 3/4 5 1/8	5 5/8 5 7/8	5 5/8 5 7/8	5 7/8 6 1/8	6 5/8 6 7/8	6 3/4 7	

NFPA MSI

DIMENSION	CYLINDER BORE								
	1 1/2	2	2 1/2	3 1/4	4	5	6	8	
ROD DIA.	5/8 1	5/8 1	5/8 1	1 1 3/8	1 1 3/8	1 1 3/8	1 3/8 1 3/4	1 3/8 1 3/4	1 3/8 1 3/4
AB	7/16	7/16	7/16	9/16	9/16	11/16	13/16	13/16	
AH	1 3/16	1 7/16	1 5/8	1 15/16	2 1/4	2 3/4	3 1/4	4 1/4	
AL	1	1	1	1 1/4	1 1/4	1 3/8	1 3/8	1 13/16	
AO	3/8	3/8	3/8	1/2	1/2	5/8	5/8	11/16	
AR	1 3/8	1 3/8	1 3/8	1 7/8	1 7/8	2	2 1/8	1 13/16	
AS	3/8	3/8	3/8	5/8	5/8	1	7/8	11/16	
AT	1/8	1/8	1/8	3/16	3/16	3/16	3/16	1/4	
S	1 1/4	1 3/4	2 1/4	2 3/4	3 1/2	4 1/4	5 1/4	7 1/8	
SA	6	6	6 1/8	7 3/8	7 3/8	7 7/8	8 1/2	8 3/4	
XA	5 5/8 6	5 5/8 6	5 3/4 6 1/8	6 7/8 7 1/8	6 7/8 7 1/8	7 1/4 7 1/2	8 8 1/4	8 7/8 8 3/16	

NFPA MS2

DIMENSION	CYLINDER BORE								
	1 1/2	2	2 1/2	3 1/4	4	5	6	8	
ROD DIA.	5/8 1	5/8 1	5/8 1	1 1 3/8	1 1 3/8	1 1 3/8	1 3/8 1 3/4	1 3/8 1 3/4	1 3/8 1 3/4
LH	1	1 1/4	1 1/2	1 7/8	2 1/4	2 3/4	3 1/4	4 1/4	
SB	7/16	7/16	7/16	9/16	9/16	13/16	13/16	13/16	
SJ	3/4 1 1/8	7/8	7/8	1 1/8	1 1/8	1 7/16	1 7/16	1 11/16	
SK	5/8	15/16	15/16	1 1/4	1 1/4	1 9/16	1 9/16	1 9/16	
SS	2 7/8	2 7/8	3	3 1/4	3 1/4	3 3/8	3 5/8	3 3/4	
ST	1/2	1/2	1/2	3/4	3/4	1	1	1	
SU	15/16	15/16	15/16	1 1/4	1 1/4	1 9/16	1 9/16	1 9/16	
SW	9/16	3/4	3/4	7/8	1	1 7/16	1 7/16	1 11/16	
TS	2 3/4	3 1/4	3 3/4	4 3/4	5 1/2	6 7/8	7 7/8	9 7/8	
US	3 1/2	4	4 1/2	5 3/4	6 1/2	8 1/4	9 1/4	11 1/4	
XS	1 3/8 1 3/4	1 3/8 1 3/4	1 3/8 1 3/4	1 7/8 2 1/8	1 7/8 2 1/8	2 1/16 2 5/16	2 5/16 2 9/16	2 5/16 2 9/16	

END LUG MOUNTS (NFPA MS7)

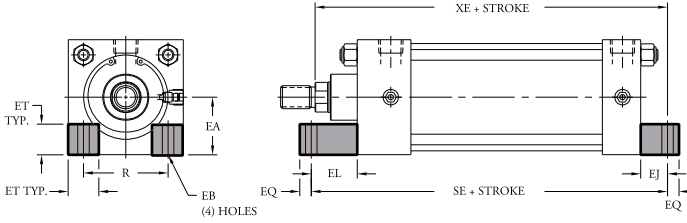

SIDE TAPPED MOUNTS (NFPA MS4)

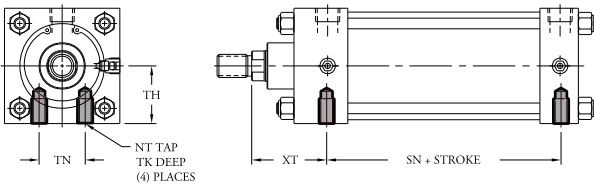

CLEVIS MOUNT (NFPA MP1)

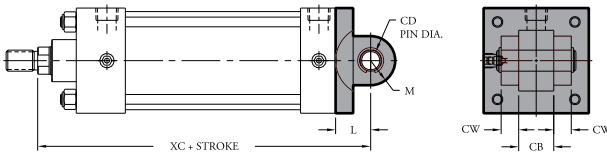

Pivot Pin Included.

CLEVIS MOUNT (NFPA MP2)

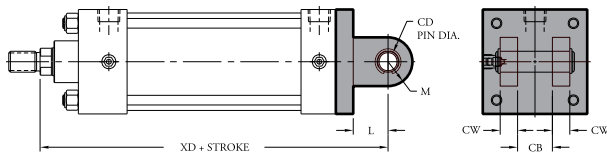

Pivot Pin Included.
Not available on 8" bore cylinders.

PIVOT MOUNT (NFPA MP4)

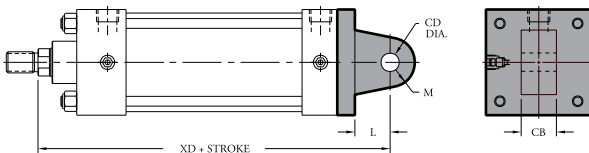

Not available on 8" bore cylinders.

NFPA MS7

DIMENSION	CYLINDER BORE							
	1 1/2	2	2 1/2	3 1/4	4	5	6	8
ROD DIA.	5/8 1	5/8 1	5/8 1	1 1 3/8 1	1 1 3/8 1	1 1 3/8 1	1 3/8 1 3/4	1 3/8 1 3/4
EA	1	1 1/4	1 1/2	1 7/8	2 1/4	2 3/4	3 1/4	4 1/4
EB	5/16	3/8	3/8	7/16	7/16	9/16	9/16	11/16
EJ	3/4 3/4	15/16	1 1/16	7/8	1	1 1/16	1	1 1/8
EL	1 1/8 3/4	1 5/16	1 7/16	1 1/2	1 5/8	1 11/16	1 3/4	1 1/8
EQ	1/4	5/16	5/16	3/8	3/8	1/2	1/2	5/8
ET	9/16	11/16	13/16	1	1 3/16	1 3/8	1 5/8	2 1/16
R	1.43	1.84	2.19	2.76	3.32	4.10	4.88	6.44
SE	5 1/2	5 7/8	6 1/4	6 5/8	6 7/8	7 1/4	7 3/4	7 3/8
XE	5 3/8 5 3/4	5 9/16 5 9/16	5 3/8 6 3/16	6 1/2 6 3/4	6 5/8 6 7/8	6 3/16 7 3/16	7 5/8 7 7/8	7 7/8 8 1/8

NFPA MS4

DIMENSION	CYLINDER BORE							
	1 1/2	2	2 1/2	3 1/4	4	5	6	8
ROD DIA.	5/8 1	5/8 1	5/8 1	1 1 3/8 1	1 1 3/8 1	1 1 3/8 1	1 3/8 1 3/4	1 3/8 1 3/4
NT	1/4-20	5/16-18	3/8-16	1/2-13	1/2-13	5/8-11	3/4-10	3/4-10
SN	2 1/4	2 1/4	2 3/8	2 5/8	2 5/8	2 7/8	3 1/8	3 1/4
TH	1	1 1/4	1 1/2	1 7/8	2 1/4	2 3/4	3 1/4	4 1/4
TK	3/8 5/16	1/2	5/8	13/16	13/16	1	1 3/16	1 1/4
TN	5/8	7/8	1 1/4	1 1/2	2 1/16	2 11/16	3 1/4	4 1/2
XT	1 5/16 2 7/16	1 5/16 2 7/16	1 5/16 2 7/16	2 7/16 2 11/16	2 7/16 2 11/16	2 7/16 2 11/16	2 3/16 3 1/16	2 3/16 3 1/16

NFPA MP1, MP2 AND MP4

DIMENSION	CYLINDER BORE							
	1 1/2	2	2 1/2	3 1/4	4	5	6	8
ROD DIA.	5/8 1	5/8 1	5/8 1	1 1 3/8 1	1 1 3/8 1	1 1 3/8 1	1 3/8 1 3/4	1 3/8 1 3/4
CB	3/4	3/4	3/4	1 1/4	1 1/4	1 1/4	1 1/2	1 1/2
CD	1/2	1/2	1/2	3/4	3/4	3/4	1	1
CW	1/2	1/2	1/2	5/8	5/8	5/8	3/4	3/4
L	3/4	3/4	3/4	1 1/4	1 1/4	1 1/4	1 1/2	1 1/2
M	5/8	5/8	5/8	7/8	7/8	7/8	1 1/4	1 1/4
XC	5 3/8 5 3/4	5 3/8 5 3/4	5 1/2 5 7/8	6 7/8 7 7/8	6 7/8 7 7/8	7 1/8 7 3/8	8 1/8 8 3/8	8 1/4 8 1/2
XD	5 3/4 6 1/8	5 3/4 6 1/8	5 7/8 6 1/4	7 1/2 7 3/4	7 1/2 7 3/4	7 3/4 8	8 7/8 9 1/8	N/A N/A

Pivot pin is included on MP1 and MP2.
See page 10 for optional pivot pin for MP4.

MOUNTING STYLES

FLAIRLINE HEAVY-DUTY

NFPA CYLINDERS

HEAD TRUNNION MOUNT (NFPA MT1)

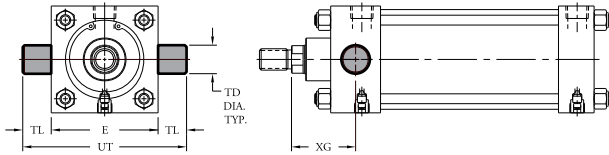

CAP TRUNNION MOUNT (NFPA MT2)

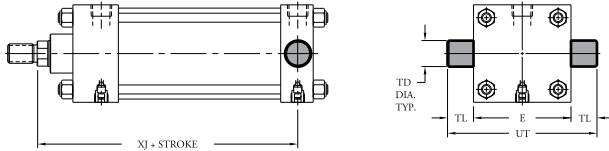

NFPA MT1 AND MT2

DIMENSION	CYLINDER BORE															
	1 1/2		2		2 1/2		3 1/4		4		5		6		8	
ROD DIA.	5/8	1	5/8	1	5/8	1	1	1 3/8	1	1 3/8	1	1 3/8	1 3/8	1 3/4	1 3/8	1 3/4
E	2	2 1/2	3	3 3/4	4 1/2	5 1/2	6 1/2	8 1/2								
TD	1	1	1	1	1	1	1 3/8	1 3/8								
TL	1	1	1	1	1	1	1 3/8	1 3/8								
UT	4	4 1/2	5	5 3/4	6 1/2	7 1/2	9 1/4	11 1/4								
XG	1 3/4	2 1/8	1 3/4	2 1/8	1 3/4	2 1/8	2 1/4	2 1/2	2 1/4	2 1/2	2 1/4	2 1/2	2 5/8	2 7/8	2 5/8	2 7/8
XJ	4 1/8	4 1/2	4 1/8	4 1/2	4 1/4	4 5/8	5	5 1/4	5	5 1/4	5 1/4	5 1/2	5 7/8	6 1/8	6	6 1/4

EXTENDED TIE RODS - FRONT AND REAR (NFPA MX1)

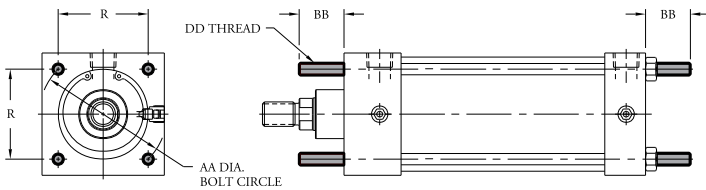

EXTENDED TIE RODS - REAR (NFPA MX2)

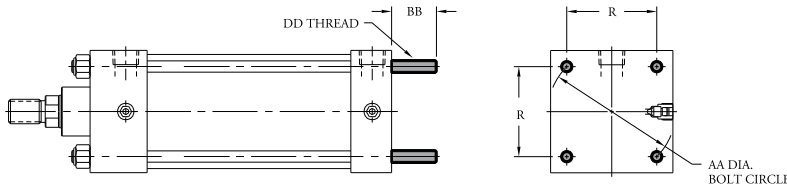

EXTENDED TIE RODS - FRONT (NFPA MX3)

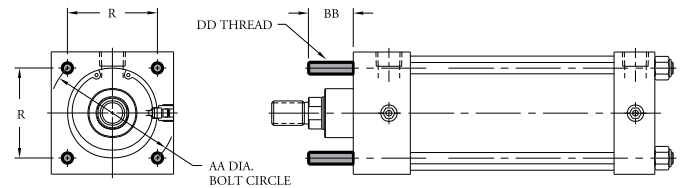

ROD END STYLES

FLAIRLINE HEAVY-DUTY

NFPA CYLINDERS

SMALL MALE (NFPA SM)*

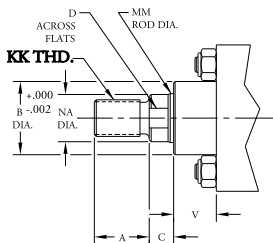

*Standard on all Flairline NFPA cylinders. When ordering, if no rod end style is specified, style SM will be supplied.

INTERMEDIATE MALE (NFPA IM)*

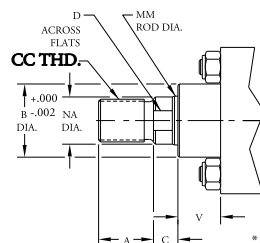

*Optional

SHORT FEMALE (NFPA SF)*

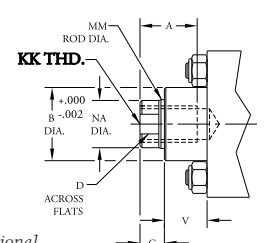

*Optional

ROD DIAMETER	DIMENSION								ROD DIAMETER	DIMENSION							
	A	B	C	CC	D	KK	NA	V		A	B	C	CC	D	KK	NA	V
5/8	3/4	1.124	3/8	1/2-20	1/2	7/16-20	.593	5/8	1 3/8	1 5/8	1.999	5/8	1 1/4-12	1 1/8	1-14	1.343	1
1	1 1/8	1.499	1/2	7/8-14	7/8	3/4-16	.968	7/8*	1 3/4	2	2.374	3/4	1 1/2-12	1 1/2	1 1/4-12	1.703	1 1/8

*1 1/2" bore, V=1/2

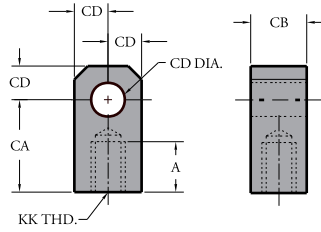

ROD EYE

PART NUMBER	DIMENSIONS				
	A	CA	CB	CD	KK
4-36-3	3/4	1 1/2	3/4	1/2	7/16-20
4-36-3A	3/4	1 1/2	3/4	1/2	1/2-20
4-36-65	1 1/8	2 1/16	1 1/4	3/4	3/4-16
4-36-65A	1 1/8	2 1/16	1 1/4	3/4	7/8-14
4-36-12	1 5/8	2 13/16	1 1/2	1	1-14
4-36-12A	2	3 7/16	2	1 3/8	1 1/4-12
4-36-12B	2	3 7/16	2	1 3/8	1 1/2-12

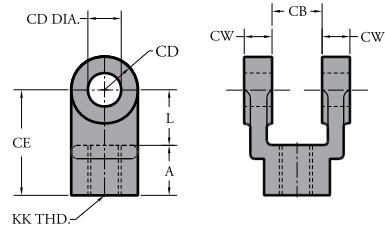

ROD CLEVIS

PART NUMBER	DIMENSIONS						
	A	CB	CD	CE	CW	L	KK
4-35-3	3/4	3/4	1/2	1 1/2	1/2	3/4	7/16-20
4-35-3A	3/4	3/4	1/2	1 1/2	1/2	3/4	1/2-20
4-35-65	1 1/8	1 1/4	3/4	2 3/8	5/8	1 1/4	3/4-16
4-35-65A	1 1/8	1 1/4	3/4	2 3/8	5/8	1 1/4	7/8-14
4-35-12	1 5/8	1 1/2	1	3 1/8	3/4	1 1/2	1-14
4-35-12A	2	2	1 3/8	4 1/8	1	2 1/8	1 1/4-12
4-35-12B	2	2	1 3/8	4 1/8	1	2 1/8	1 1/2-12

Pivot pin included.

CLEVIS BRACKET

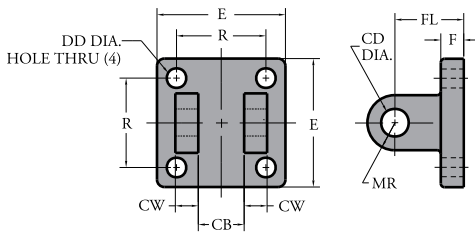

PART NUMBER	DIMENSIONS									
	CB	CD	CW	DD	E	F	FL	MR	R	
5-34-3	3/4	1/2	1/2	13/32	2 1/2	3/8	1 1/8	1/2	1 5/8	
5-34-65	1 1/4	3/4	5/8	17/32	3 1/2	5/8	1 7/8	3/4	2 9/16	
5-34-12	1 1/2	1	3/4	21/32	4 1/2	3/4	2 1/4	1 1/8	3 1/4	
5-34-12A	2	1 3/8	1	21/32	5	7/8	3	1 3/4	3 13/16	
5-34-16	2 1/2	1 3/4	1 1/4	29/32	6 1/2	7/8	3 1/8	1 7/8	4 15/16	

Pivot pin included.

PIVOT BRACKET

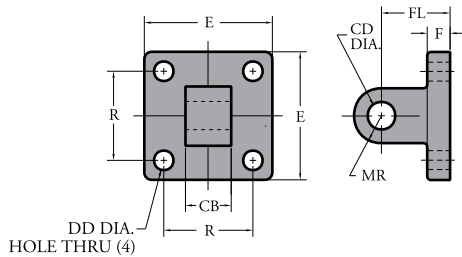

PART NUMBER	DIMENSIONS								
	CB	CD	DD	E	F	FL	MR	R	
5-37-3	3/4	1/2	13/32	2 1/2	3/8	1 1/8	1/2	1 5/8	
5-37-65	1 1/4	3/4	17/32	3 1/2	5/8	1 7/8	3/4	2 9/16	
5-37-12	1 1/2	1	21/32	4 1/2	7/8	2 3/8	1 1/4	3 1/4	
5-37-12A	2	1 3/8	21/32	5	7/8	3	1 5/8	3 13/16	
5-37-16	2 1/2	1 3/4	29/32	6 1/2	1 1/8	3 3/8	2 1/8	4 15/16	

See optional pivot pin below.

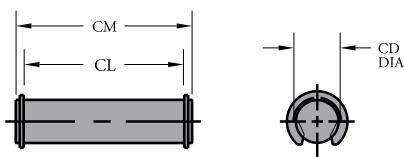

PIVOT PIN

PART NUMBER	DIMENSIONS		
	CD	CL	CM
BKT. PIN F 3/4, 4	1/2	1 7/8	2 1/16
PIVOT PIN Fl 3/4, 4	3/4	2 5/8	2 29/32
5-40-12	1	3 1/8	3 7/16
5-40-12A	1 3/8	4 1/8	4 31/64
5-40-16	1 3/4	5 3/16	5 9/16

Snap rings included.

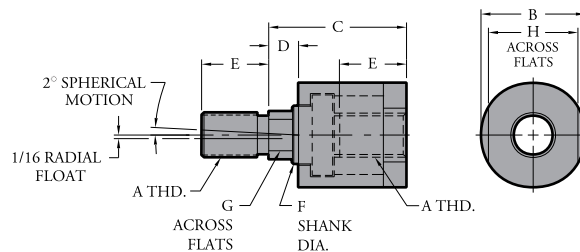

ALIGNMENT COUPLER

PART NUMBER	DIMENSIONS									Max. Pull At Yield
	A	B	C	D	E	F	G	H		
4-39-3	7/16-20	1 1/4	2	1/2	3/4	5/8	1/2	1	10,000	
4-39-3A	1/2-20	1 1/4	2	1/2	3/4	5/8	1/2	1	14,000	
4-39-65	3/4-16	1 3/4	2 5/16	1/2	1 1/8	31/32	13/16	1 1/2	34,000	
4-39-65A	7/8-14	1 3/4	2 5/16	1/2	1 1/8	31/32	13/16	1 1/2	39,000	
4-39-12	1-14	2 1/2	2 15/16	1/2	1 5/8	1 3/8	1 5/32	2 1/4	64,000	
4-39-12A	1 1/4-12	2 1/2	2 15/16	1/2	1 5/8	1 3/8	1 5/32	2 1/4	78,000	
4-39-16	1 1/2-12	3 1/4	4 3/8	13/16	2 1/4	1 3/4	1 1/2	3	134,000	

Alignment couplers improve bearing and seal life by preventing excessive binding and friction caused by misalignment. Flairline alignment couplers also allow greater assembly tolerances than would typically be required which help simplify cylinder installation. Alignment couplers work equally well in "push" or "pull" applications.

MAGNETIC SWITCH OPTIONS

FLAIRLINE HEAVY-DUTY
SERIES TM, TSM, TMDE AND TSMDE

REED SWITCH NO. 43-CRT

Warning –
Do not exceed
Ratings.
Permanent
damage to
sensor may
occur.

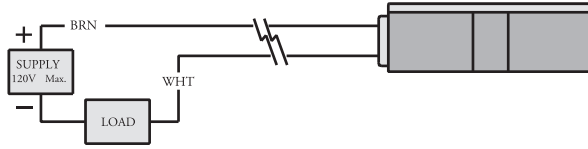

REED SWITCH NO. 43-CRR

Warning –
Do not exceed
Ratings.
Permanent
damage to
sensor may
occur.

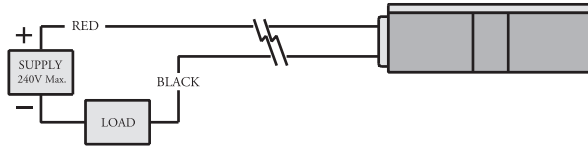

HALL EFFECT SWITCH NO. 43-HPT

Warning –
Do not exceed
24 VDC.
Permanent
damage to
sensor may
occur.

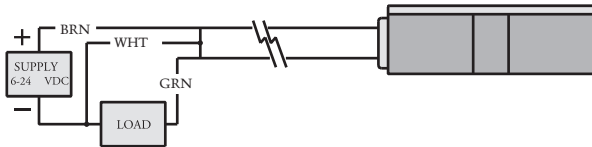

HALL EFFECT SWITCH NO. 43-HNT

Warning –
Do not exceed
24 VDC.
Permanent
damage to
sensor may
occur.

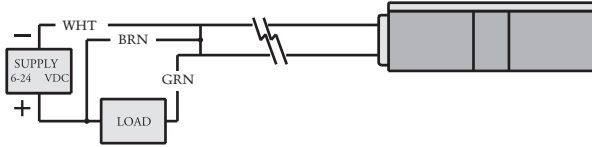

Power Supply Polarity MUST be observed for proper operation.
FAILURE TO OBSERVE POLARITY WILL CAUSE DAMAGE TO SWITCH.

Temperature Range – operational from -30° to +80°C
Shock – operational up to 30G (11msec./Reeds only. Not applicable for Halls.
Vibration – operational up to 20G (10-55 Hz)/Reeds only. Not applicable for Halls.

MOUNTING CLAMP - INCLUDED WITH SWITCHES

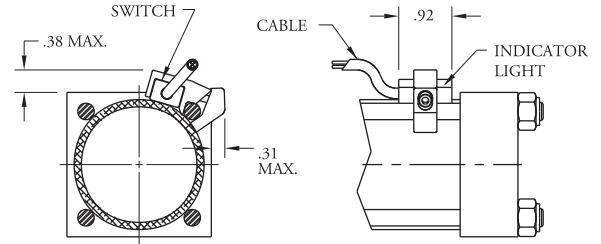

For use on 1½ through 2½ bore cylinders
(43-CRT, 43-HPT and 43-HNT).

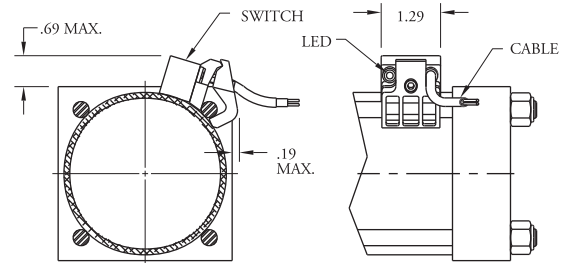

For use on 3¼ through 8 bore cylinders
(43-CRR, 43-HPP and 43-HNN).

HALL EFFECT SWITCH NO. 43-HPP

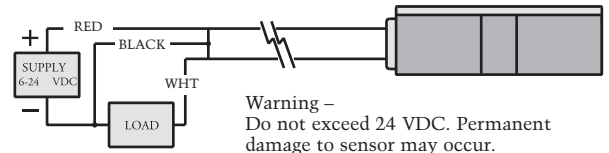

Warning –
Do not exceed 24 VDC. Permanent
damage to sensor may occur.

HALL EFFECT SWITCH NO. 43-HNN

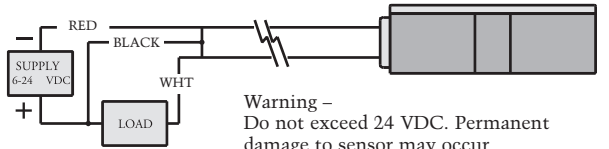

Warning –
Do not exceed 24 VDC. Permanent
damage to sensor may occur.

SENSOR TYPES AND TECHNICAL DATA

PART NO.	DESCRIPTION	FUNCTION	SWITCHING VOLTAGE	SWITCHING CURRENT	SWITCHING POWER	SWITCHING SPEED	MAX. VOLT. DROP	SENSITIVITY
43CRT	Reed Switch MOV, LED	SPST Normally Open	5-120 VDC/VAC 50/60 HZ	0.5 Amp Max 0.005 Amp Min.	10 Watts Max.	0.5ms operate 0.1ms release	3.5 Volts	85 Gauss
43HPT	Half Effect, LED Sourcing	Normally Open PNP output	6-24 VDC	0.5 Amp max.	12 Watts Max.	1.5µ operate 0.5µ release	0.5 Volts	85 Gauss
43HNT	Half Effect, LED Sinking	Normally Open NPN output	6-24 VDC	0.5 Amp max.	12 Watts Max.	1.5µ operate 0.5µ release	0.5 Volts	85 Gauss
43CRR	Reed Switch MOV, LED	SPST Normally Open	5-240 VDC/VAC 50/60 Hz	1 Amp Max .005 Amp Min.	30 Watts Max.	0.6 ms operate 0.05 ms release	3 Volts	85 Gauss
43HPP	Half Effect, LED Sourcing	Normally Open PNP output	6-24 VDC	1 Amp Max	24 Watts Max.	1.5µ operate 0.5µ release	0.5 Volts	85 Gauss
43HNN	Half Effect, LED Sinking	Normally Open NPN output	6-24 VDC	1 Amp Max	24 Watts Max.	1.5µ operate 0.5µ release	0.5 Volts	85 Gauss

FORCE CHART FOR EXTEND AND RETRACT (POUNDS OF FORCE)															
BORE	ROD DIA.	AREA	NET AREA	OPERATING PRESSURE (P.S.I.)											
				40	50	60	80	90	100	125	150	200	250	300	400
1 1/2		1.767	1.767	71	88	106	141	159	177	221	265	353	442	530	706
	5/8	0.307	1.460	58	73	88	117	131	146	183	219	292	365	438	584
	1	0.785	0.982	39	49	59	79	88	98	123	147	196	245	294	392
2		3.142	3.142	126	157	188	251	282	314	393	471	628	785	942	1256
	5/8	0.307	2.835	113	142	170	227	255	283	354	425	567	709	850	1134
	1	0.785	2.356	94	118	141	188	212	236	295	353	471	589	706	942
2 1/2		4.909	4.909	196	245	295	393	441	491	614	736	982	1227	1472	1963
	5/8	0.307	4.602	184	230	276	368	414	460	575	690	920	1150	1380	1840
	1	0.785	4.123	165	206	247	330	371	412	515	619	825	1031	1236	1649
3 1/4		8.296	8.296	332	415	498	664	746	830	1037	1244	1657	2074	2488	3318
	1	0.785	7.510	300	376	451	601	675	751	939	1127	1502	1878	2253	3004
	1 3/8	1.485	6.811	272	341	409	545	612	681	851	1022	1362	1703	2043	2724
4		12.566	12.566	503	628	754	1005	1130	1257	1571	1855	2513	3142	3769	5026
	1	0.785	11.781	471	589	707	942	1060	1178	1473	1767	2356	2945	3534	4712
	1 3/8	1.485	11.082	443	554	665	887	997	1108	1385	1662	2216	2770	3324	4432
5		19.635	19.635	785	982	1178	1571	1767	1964	2454	2945	3927	4909	5890	7854
	1	0.785	18.850	754	942	1131	1508	1696	1885	2356	2827	3770	4712	5655	7540
	1 3/8	1.485	18.150	726	908	1089	1452	1633	1815	2269	2723	3630	4538	5445	7260
6		28.274	28.274	1131	1414	1696	2262	2544	2827	3534	4241	5655	7069	8482	11309
	1 3/8	1.485	26.790	1072	1339	1607	2143	2411	2679	3349	4018	5358	6697	8037	10716
	1 3/4	2.405	25.869	1035	1293	1552	2070	2328	2587	3234	3880	5174	6467	7760	10347
8		50.266	50.266	2011	2513	3016	4021	4523	5027	6283	7540	10053	12566	15079	20106
	1 3/8	1.485	48.781	1951	2439	2927	3902	4390	4878	6098	7317	9756	12195	14634	19512
	1 3/4	2.405	47.860	1914	2393	2872	3829	4307	4786	5983	7179	9572	11965	14358	19144

Figures in bold type indicate pounds of force generated when cylinder extends (push). Figures not in bold type indicate pounds of force generated when cylinder retracts (pull) with various rod diameters.

**FLUID POWER
FORMULAS**

FORMULA FOR:	WORD FORMULA	LETTER FORMULA
AIR PRESSURE <i>In Pounds/Square Inch</i>	PRESSURE = $\frac{\text{FORCE (Pounds)}}{\text{UNIT AREA (Square Inches)}}$	$P = \frac{F}{A}$ or $\text{psi} = \frac{F}{A}$
CYLINDER PISTON AREA <i>In Square Inches</i>	AREA = $\pi \times \text{RADIUS}^2$ (Inches)	$A = \pi r^2$
CYLINDER OUTPUT FORCE <i>In Pounds, Push or Pull</i>	FORCE = Pressure (psi) x NET AREA (Square Inches)	$F = \text{psi} \times A$ or $F = PA$
CYLINDER VELOCITY <i>or SPEED In Feet/Second</i>	VELOCITY = $\frac{231 \times \text{FLOW RATE (GPM)}}{12 \times 60 \times \text{NET AREA (Square Inches)}}$	$v = \frac{231Q}{720A}$ or $v = \frac{.3208Q}{A}$
CYLINDER VOLUME CAPACITY <i>In Cubic Ft. of Air</i>	VOLUME = $\frac{\text{PISTON AREA (Square Inches)} \times \text{STROKE (Inches)}}{1728}$	$V = \frac{AI}{1728}$ l = Length of Stroke
FREE AIR USAGE <i>(Output Volume of Free Air in Cubic Ft.) Used to size a Compressor</i>	FREE AIR (psia) = $\frac{\text{Cyl. Piston Area in Sq. Inches} \times \text{Cyl. Stroke in Inches} \times (\text{Cyl. Output Force} + 14.7)}{14.7 \times 1728}$	$\text{FA (Cu.Ft.)} = \frac{A \times \text{Stroke} \times (\text{Force} + 14.7)}{14.7 \times 1728}$

ROD DIAMETER SELECTION

FLAIRLINE HEAVY-DUTY
NFPA CYLINDERS

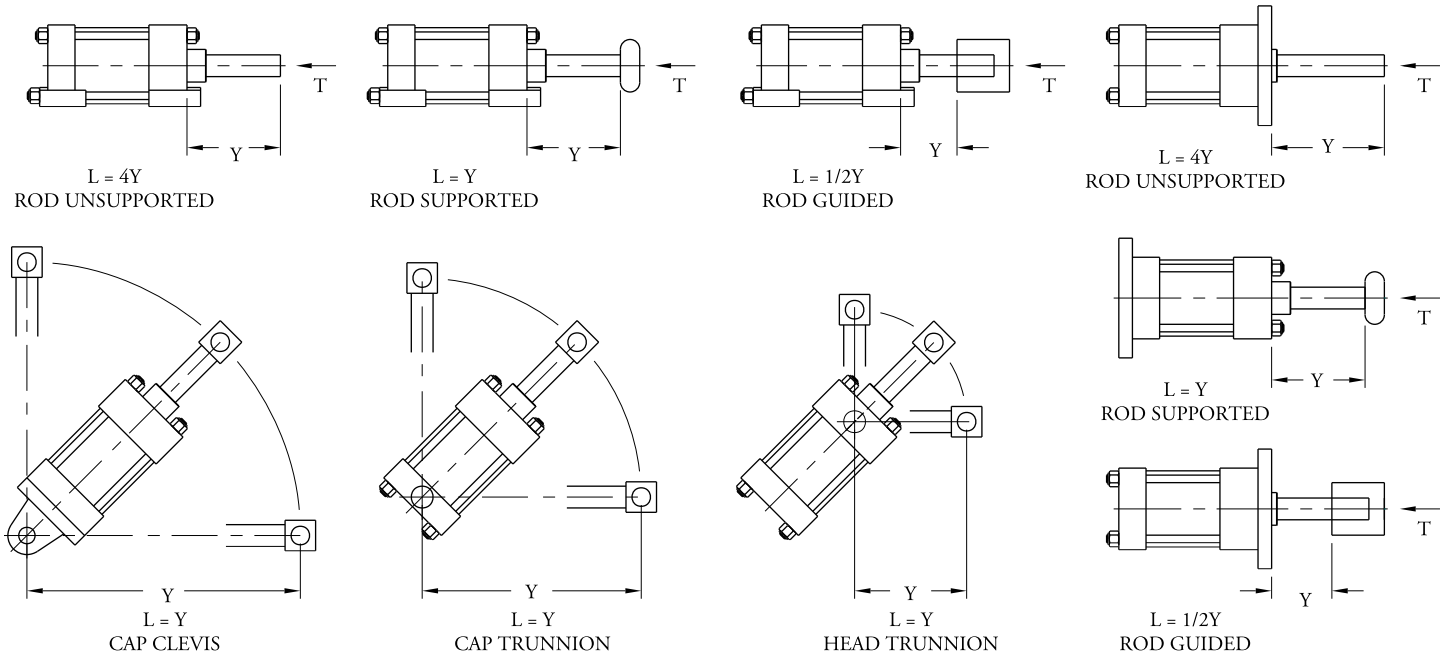

All rods shown in extended position.

In most cylinder applications, the standard rod diameter is suitable. In long stroke or high force applications, an oversized rod may be required. To select the minimum rod size for a particular application, determine bore size, stroke and force (see page 12). Select the type of mount from the above illustrations and determine the "L" length with the rod fully extended. Using the chart to the right, find the maximum force for your application, then look across that row and find the "L" length calculated from above drawing. If the exact value is not shown, use the next larger number to determine the appropriate rod diameter for your cylinder.

FORCE IN POUNDS	PISTON ROD DIAMETER			
	5/8	1	1 3/8	1 3/4
50	62			
100	55	112		
200	47	99		
300	44	88	142	
500	38	75	130	180
750	28	70	122	170
1,000	25	60	103	156
1,250	21	52	94	140
1,500	19	50	92	136
2,000	15	43	81	113
4,000	12	31	62	96
6,000		25	52	80
8,000		22	45	75
10,000		21	40	67
20,000			27	48
30,000				40

STOP TUBE SELECTION

FLAIRLINE HEAVY-DUTY
NFPA CYLINDERS

Stop tubes are located between the piston and the head on long stroke cylinders. Stop tubes add length to the distance between the piston and the rod bearing which reduces the bearing load when the cylinder is fully extended.

To determine if a stop tube is required and the length of the stop tube, determine the "L" length from the above drawings. If "L" is less than 40 inches, no stop tube is required. If "L" is over 40 inches, one inch of stop tube is recommended for every 10 inches or fraction thereof which is over 40 inches.

"L" (INCHES)	STOP TUBE LENGTH (INCHES)
0-40	0
41-50	1
51-60	2
61-70	3
71-80	4
81-90	5
91-100	6

"L" (INCHES)	STOP TUBE LENGTH (INCHES)
101-110	7
111-120	8
121-130	9
131-140	10
141-150	11
151-160	12
161-170	13

Note: "L" is calculated from mounting point with rod extended.

OPTIONS

SPECIFY AFTER MOUNTING STYLE:

Cushions (not available on head-end of 1 1/2 bore cylinders with oversized rods)	(See page 15 for ordering information)
Metal rod scraper	MRS
3/8" inlet ports (available on 1 1/2, 2 and 2 1/2 bore cylinders – 1/4" ports are standard)	Ports 3/8"
Extra inlet ports head and/or cap end	Extra port(s) [indicate location(s) <i>and</i> head and/or cap end]
Inlet ports non-standard location – head and/or cap end	Port(s) [indicate location(s) <i>and</i> head and/or cap end]
Non-stock stroke cylinders	(See page 15 for ordering information)
Viton packing (available on Series T, TS, TDE and TSDE).....	Viton
Magnetic switches (available on Series TM, TSM, TMDE and TSMDE).....	(See page 15 for ordering information)
Stop tubes	(See page 15 for ordering information)

SPECIAL ROD OPTIONS

SPECIFY AFTER MOUNTING STYLE:

Rod end styles Intermediate Male (NFPA IM) or Short Female (NFPA SF)	IM or SF*
Special dimension "C" (rod extension)	C = (indicate dimension required)
Special dimension "A" (thread length)	A = (indicate dimension required)
Special dimension "XX" (male thread size)	XX = (indicate thread size required or plain rod end)
Tapped hole in end of rod (female thread size)	XX = (indicate size and depth required - unless otherwise specified, all other dimensions will be Short Female)
Stainless steel rods	SS Rod

**If no rod end style is specified, Small Male (NFPA SM) will be supplied.*

ORDERING INSTRUCTIONS

To order any products, specify information from categories listed below and arrange according to 'Example.'

Example:

<u>TM</u>	<u>2</u>	<u>HPP</u>	<u>5</u>	<u>X</u>	<u>12</u>	<u>C</u>	<u>MF1</u>	<u>MRS</u>	<u>IM</u>
Special Options*****									
Series	No. of Switches	Switch Model*	Bore	Stroke**	Cushions***	Code	Mounting Style****		
T, TS TL, TLS	N/A	N/A	1 1/2, 2, 2 1/2	1" to 18" (1" increments)	Head only Cap only Both	H C HC	MF1, MF2, FC1, FC2 MS1, MS2, MS7, MS4 MP1, MP2, MP4, MT1 MT2, MX1, MX2, MX3		
TDE TSDE			3 1/4, 4, 5, 6, 8		One end only Both	H HH			
TM TSM	Qty.	43-CRT 43-HPT 43-HNT	1 1/2, 2, 2 1/2		Head only Cap only Both	H C HC			
		43-CRR 43-HPP 43-HNN	3 1/4, 4, 5, 6, 8		One end only Both	H HH			
TMDE TSMDE		43-CRT 43-HPT 43-HNT	1 1/2, 2, 2 1/2		One end only Both	H HH			
		43-CRR 43-HPP 43-HNN	3 1/4, 4, 5, 6, 8						

*Use suffix only.

**Cylinders are available in even inch increments of stroke (1" to 18") plus 1 1/2", 2 1/2", and 3 1/2" strokes in bore sizes 1 1/2 and 2. All others (up to 130" total stroke) are considered non-stock. The use of a stop tube effects stroke. See page 13 for "Stop Tube Selection" to determine if a stop tube is required.

***Cushion not available on head-end of 1 1/2 bore cylinders with oversized rods.

****MP1, MP2, and MP4 are not available on Series TDE, TSDE, TMDE or TSMDE (double-ended cylinders). MF1, MF2, MP2 and MP4 are not available on 8" bore cylinders.

*****The special options in the example are metal rod scraper and rod end style – Intermediate Male (NFPA IM).

SPECIAL NOTE: WHEN ORDERING A CYLINDER WITH A STOP TUBE, SPECIFY "TOTAL" STROKE INCLUDING THE STOP TUBE LENGTH IN THE "STROKE" CATEGORY. IN THE "SPECIAL OPTIONS" CATEGORY, SPECIFY THE STOP TUBE LENGTH.

REPLACEMENT PARTS, PACKING KITS AND LUBRICANTS ARE AVAILABLE FOR ALL FLAIRLINE CYLINDERS.

Flairline will not assume responsibility for the application of its products. All specifications and dimensions are subject to change without notice.

FLAIRLINE[®] HEAVY-DUTY NFPA CYLINDERS
