

# HIGH FLOW 2-WAY N.C. 15 MM VALVES



## Specifications

**Medium:** Air, Gas, or other Compatible Fluids

**Working Pressure:** 0 to 43 psig

**Maximum Flow Rate:** 120 l/min

**Orifice:** 0.118"

**Material:** Stainless steel core and springs, nylon body, FKM seals, and Nitrile gasket.

**Response Time:** 10 ms when energized; 12 ms when de-energized

**Voltage:** 12-volt DC or 24-volt DC

**Voltage Tolerance:** -5% to +10%

**Power Consumption:** 4.0 watts

**Coil Insulation Class:** F 311°F

**Temperature Range:** 23 to 122°F



### 90° Connector with LED

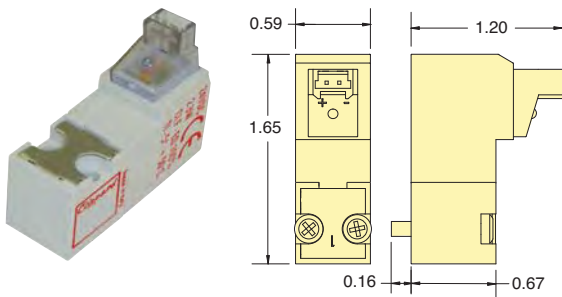

### In-Line Connector with LED

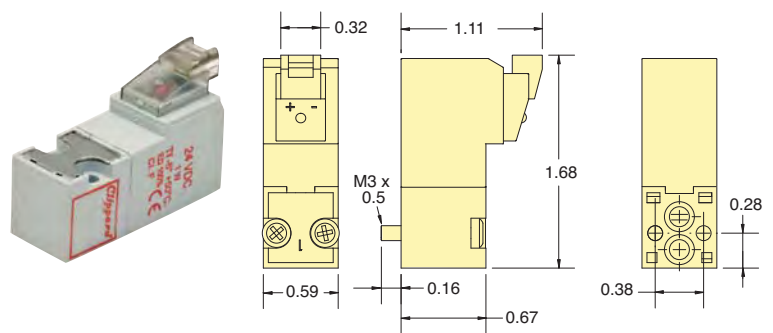

Part No.	Connector	Voltage
<a href="#">E215H-3L012</a>	90° Connector	12 VDC
<a href="#">E215H-3L024</a>	90° Connector with LED	24 VDC
<a href="#">E215H-3C012</a>	In-Line Connector	12 VDC
<a href="#">E215H-3C024</a>	In-Line Connector with LED	24 VDC

### Mounting Interface

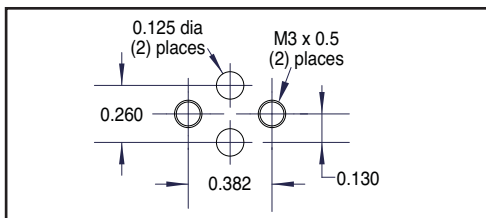

### Typical Air Flow

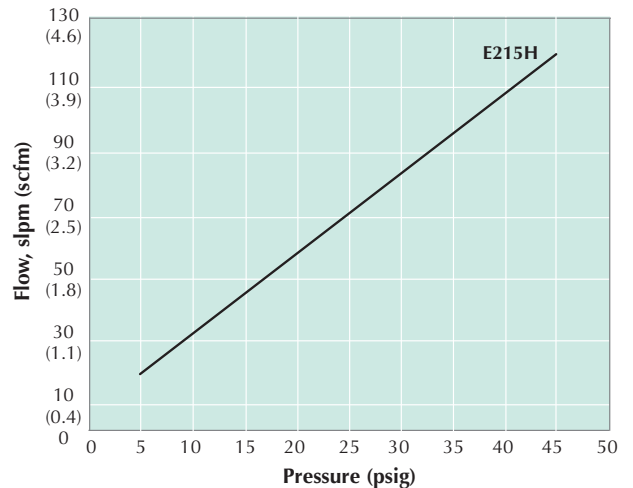

### 15 mm High Flow Single-Station Manifold

Spare hardware and closing plates available.

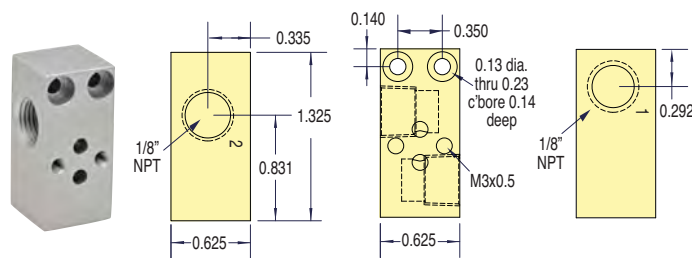

**Part No.**  
[E15HM-01](#) 15 mm Single-Station Manifold

Metric line available. Visit [www.clippard.com](http://www.clippard.com)

### Functional Schematics

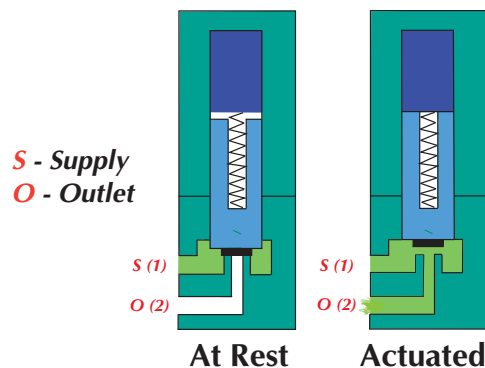





# Maximatic®



## Maximatic Solenoid Valves

Clippard's Maximatic Solenoid valves are available in 2-way, 3-way and 4-way configurations in port sizes from #10-32 to 1/2" NPT. Select either a direct-acting poppet or solenoid-controlled pilot operated balanced spool design. Spool valves are body ported but can be bolted to a parallel circuit manifold.

These electronic valves offer high flow in a small package, and are constructed of aluminum, stainless steel and thermoplastic materials. The 4-way valves are also available in 3 position versions with either pressure center, closed center or exhaust center spool options.

**Materials:** Aluminum, Stainless Steel, Thermoplastic

**Maximum Pressure:** 0 to 115 psig (direct-acting only); 30 to 125 on MME-41 Series, 20 to 125 psig on all others (spool valves)

**Response Time:** Less than 20 milliseconds

**Mounting:** Manifold standard. Actuator (1/4" only) or NAMUR (3/8" NPT only) available.

**Manual Override:** Locking or non-locking

**Electrical Connection:** DIN terminal with LED indicator, or 18" Wire Leads

**DIN Connector:** Plug-in electrical connector with LED. MME-31/41 models are DIN Industrial Form "C" (9.4 mm centers) 3 mm screw. All others are DIN 43650 Form "B" 3 mm screw. LED will not "light" if polarity is reversed.

**Wire Leads:** Not polarity sensitive

**Temperature Range:** 32 to 150°F

**Seals:** Nitrile

Conforms to ISO 19973-2 test standards.

3- & 4-Way Valves

Port	Cv	Flow Rate	
		@ 50 psig	@ 100 psig
#10-32	0.58	16 scfm	27 scfm
1/8" NPT	0.67	18 scfm	31 scfm
1/4" NPT	0.89	26 scfm	49 scfm
3/8" NPT	1.68	51 scfm	93 scfm
1/2" NPT	2.79	91 scfm	171 scfm

Metric line available. Visit [www.clippard.com](http://www.clippard.com)



## Maximum Value. Maximum Performance.

For side ported manifold mount, the Maximatic line of valves offers both 1/4" actuator mount and 3/8" NAMUR mount

2-Way, 3-Way & 4-Way Designs

Choose either DIN connector with LED indicator or 18" Wire Lead connection. Both are rotatable and interchangeable.

Easily accessible locking or non-locking manual override switch

Port sizes from #10-32 to 1/2" NPT

Small size makes valves ideal for use in compact applications

Nitrile Seals

Sturdy aluminum body withstands rough environments

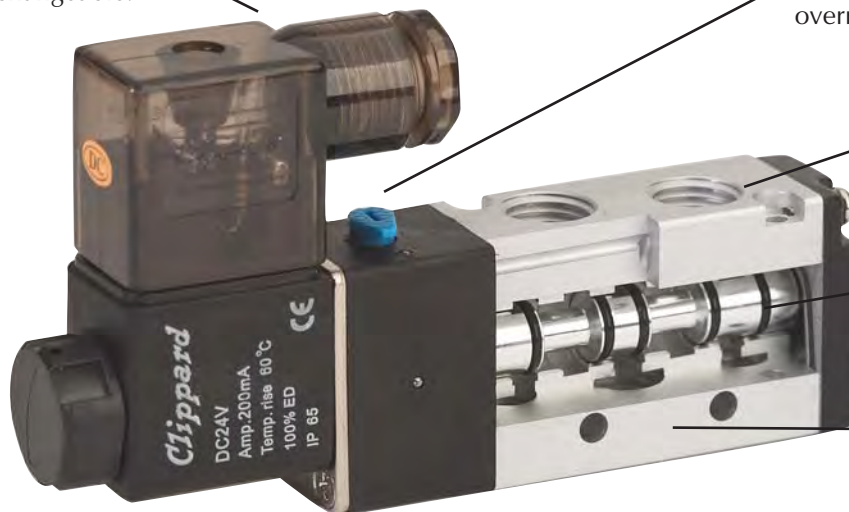

Operating ranges to 125 psig

Closed Center, Pressure Center and Exhaust Center Models Available

Maximatic® Valves are available as body ported, manifold mount, NAMUR (3/8" NPT only), and Actuator (1/4" NPT only) mounting. Standard models include a base that permits fast, secure mounting of electronic valves to a manifold for grouping in compact assemblies.

A wide variety of voltage options are available including 12 VDC, 24 VDC, 24 VAC, 110 VAC and 220 VAC. Consult factory for other voltages.

All Maximatic® Solenoid Valves are IP 65 CE Rating

# MAXIMATIC® SOLENOID VALVES

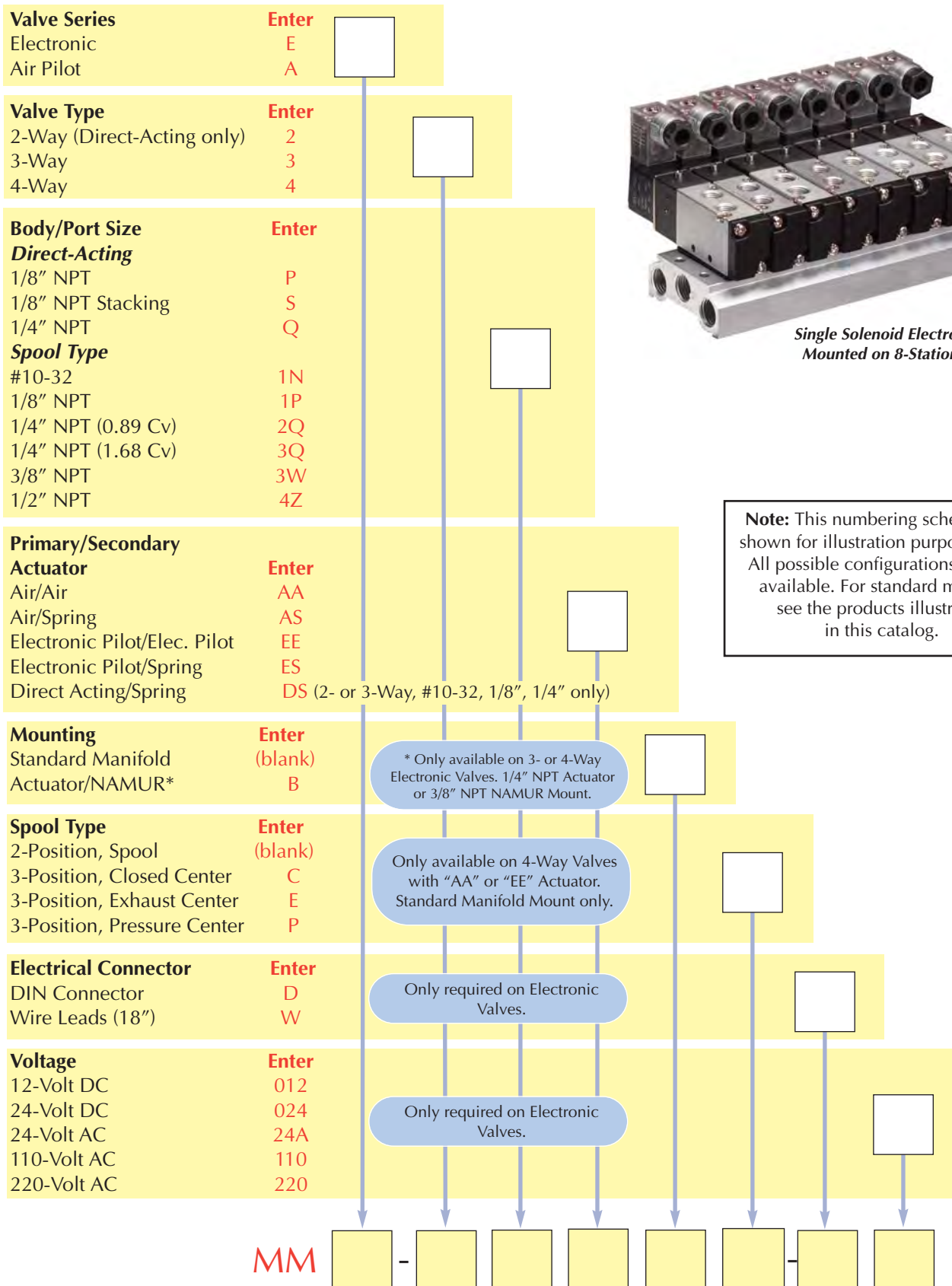

Single Solenoid Electronic Valves Mounted on 8-Station Manifold

**Note:** This numbering schematic is shown for illustration purposes only. All possible configurations are not available. For standard models, see the products illustrated in this catalog.

Metric line available. Visit [www.clippard.com](http://www.clippard.com)

Example: MM  E -  4  2Q  ES -  D  110





# MAXIMATIC® SOLENOID VALVES

2-Way Valves										
Series No.	Style	Inlet	Ports Outlet	Exhaust	Function	Cv	Flow @ 100 psig			
MME-2PDS	Poppet	1/8" NPT	1/8" NPT	1/8" NPT	2/2	0.12	6.7 scfm			
MME-2QDS	Poppet	1/4" NPT	1/4" NPT	1/4" NPT	2/2	0.12	6.7 scfm			
MME-2SDS	Poppet	1/8" NPT	1/8" NPT	1/8" NPT	2/2	0.05	2.3 scfm			
3-Way Valves										
Series No.	Style	Inlet	Ports Outlet	Exhaust	Function	Cv	Flow @ 100 psig			
MME-3PDS	Poppet	1/8" NPT	1/8" NPT	1/8" NPT	3/2	0.12	6.7 scfm			
MME-3QDS	Poppet	1/4" NPT	1/4" NPT	1/4" NPT	3/2	0.12	6.7 scfm			
MME-3SDS	Poppet	1/8" NPT	1/8" NPT	1/8" NPT	3/2	0.05	2.3 scfm			
MME-31NES	Spool	#10-32	#10-32	#10-32	3/2 NC	0.58	27 scfm			
MME-31PES	Spool	1/8" NPT	1/8" NPT	1/8" NPT	3/2 NC	0.67	31 scfm			
MME-32QES	Spool	1/4" NPT	1/4" NPT	1/8" NPT	3/2 NC	0.89	49 scfm			
MME-33WES	Spool	3/8" NPT	3/8" NPT	1/4" NPT	3/2 NC	1.68	93 scfm			
MME-34ZES	Spool	1/2" NPT	1/2" NPT	1/2" NPT	3/2 NC	2.79	171 scfm			
MME-31NEE	Spool	#10-32	#10-32	#10-32	3/2	0.58	27 scfm			
MME-31PEE	Spool	1/8" NPT	1/8" NPT	1/8" NPT	3/2	0.67	31 scfm			
MME-32QEE	Spool	1/4" NPT	1/4" NPT	1/8" NPT	3/2	0.89	49 scfm			
MME-33WEE	Spool	3/8" NPT	3/8" NPT	1/4" NPT	3/2	1.68	93 scfm			
MME-34ZEE	Spool	1/2" NPT	1/2" NPT	1/2" NPT	3/2	2.79	171 scfm			
4-Way Valves										
Series No.	Style	Inlet	Ports Outlet	Exhaust	Function	Cv	Flow @ 100 psig	Spool Configuration		
								Flow @ 100 psig	Center	Exhaust Center
MME-41NES	Spool	#10-32	#10-32	#10-32	5/2	0.58	27 scfm			
MME-41PES	Spool	1/8" NPT	1/8" NPT	1/8" NPT	5/2	0.67	31 scfm			
MME-42QES	Spool	1/4" NPT	1/4" NPT	1/8" NPT	5/2	0.89	49 scfm			
MME-43WES	Spool	3/8" NPT	3/8" NPT	1/4" NPT	5/2	1.68	93 scfm			
MME-44ZES	Spool	1/2" NPT	1/2" NPT	1/2" NPT	5/2	2.79	171 scfm			
MME-41NEE	Spool	#10-32	#10-32	#10-32	5/2	0.58	27 scfm			
MME-41PEE	Spool	1/8" NPT	1/8" NPT	1/8" NPT	5/2	0.67	31 scfm			
MME-42QEE	Spool	1/4" NPT	1/4" NPT	1/8" NPT	5/2	0.89	49 scfm			
MME-43WEE	Spool	3/8" NPT	3/8" NPT	1/4" NPT	5/2	1.68	93 scfm			
MME-44ZEE	Spool	1/2" NPT	1/2" NPT	1/2" NPT	5/2	2.79	171 scfm			
MME-41NEEC	Spool	#10-32	#10-32	#10-32	5/3	0.50	23 scfm		•	
MME-41PEEC	Spool	1/8" NPT	1/8" NPT	1/8" NPT	5/3	0.50	23 scfm		•	
MME-42QEEC	Spool	1/4" NPT	1/4" NPT	1/8" NPT	5/3	0.67	49 scfm		•	
MME-43WEEC	Spool	3/8" NPT	3/8" NPT	1/4" NPT	5/3	1.00	72 scfm		•	
MME-44ZEEC	Spool	1/2" NPT	1/2" NPT	1/2" NPT	5/3	1.68	93 scfm		•	
MME-41NEEP	Spool	#10-32	#10-32	#10-32	5/3	0.50	23 scfm			•
MME-41PEEP	Spool	1/8" NPT	1/8" NPT	1/8" NPT	5/3	0.50	23 scfm			•
MME-42QEEP	Spool	1/4" NPT	1/4" NPT	1/8" NPT	5/3	0.89	49 scfm			•
MME-43WEEP	Spool	3/8" NPT	3/8" NPT	1/4" NPT	5/3	1.00	72 scfm			•
MME-44ZEEP	Spool	1/2" NPT	1/2" NPT	1/2" NPT	5/3	1.68	93 scfm			•
MME-41NEEE	Spool	#10-32	#10-32	#10-32	5/3	0.50	23 scfm			•
MME-41PEEE	Spool	1/8" NPT	1/8" NPT	1/8" NPT	5/3	0.50	23 scfm			•
MME-42QEEE	Spool	1/4" NPT	1/4" NPT	1/8" NPT	5/3	0.89	49 scfm			•
MME-43WEEE	Spool	3/8" NPT	3/8" NPT	1/4" NPT	5/3	1.00	72 scfm			•
MME-44ZEEE	Spool	1/2" NPT	1/2" NPT	1/2" NPT	5/3	1.68	93 scfm			•

## Direct-Acting 2-Position Solenoid Valves



Maximatic® Direct-Acting Valves are single solenoid spring return poppet type valves available as either 2-way or 3-way configurations in ports sizes 1/8" NPT and 1/4" NPT. Hardware to stack multiple valves included with each stacking valve (MME-3SDS and MME-2SDS).

Includes two long screws, two short screw, one gasket, and two nuts.

**Medium:** Air (40 micron filtration), Inert Gas or Liquid  
**Operating Range:** 0 to 115 psig  
**Flow:** 2.3 scfm @ 100 psig  
**Electrical Connection:** DIN connector with LED indicator ("D"), or 18" Wire Lead ("-W")  
**Voltage:** 12-volt DC ("-012"), 24-volt DC ("-024"), 24-volt AC ("-24A"), 110-volt AC ("-110"), or 220-volt AC ("-220")  
**Power Consumption:** 6.5 Watt  
**Number of Ports:** 2 or 3  
**Mounting:** Body Ported or Stacking

### Replacement Stacking Kit

Replacement Stacking Kits are available which include two long screws, two short screws, one gasket and two nuts.

Part No.	Description
<u>27048</u>	Replacement Stacking Kit

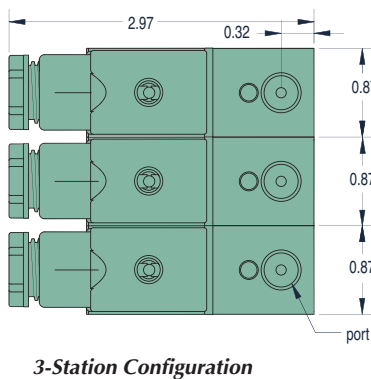

### 2-Way & 3-Way Valves (stacking)

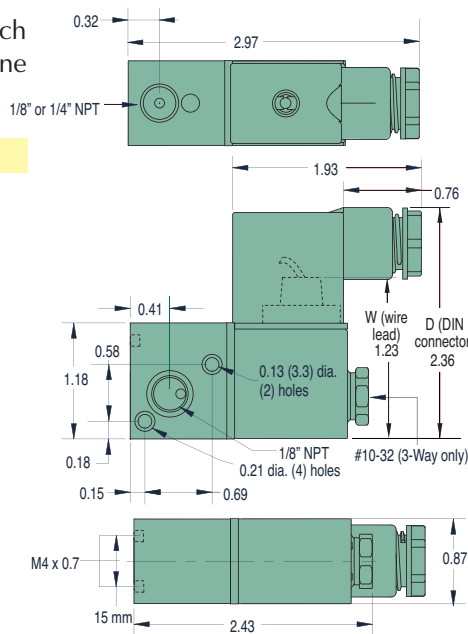

### 2-Way & 3-Way Valves (non-stacking)

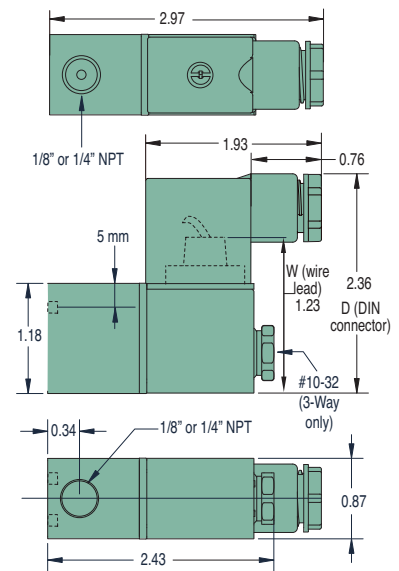

2-Way Valves	Cv/scfm*	3-Way Valves	Inlet	Outlet	Exhaust	Cv/scfm*
<u>MME-2PDS-</u> A	0.12/6.7	<u>MME-3PDS-</u> A	1/8" NPT	1/8" NPT	#10-32	0.10/2.3
<u>MME-2SDS-*</u> W	0.05/2.3	<u>MME-3SDS-*</u> W	1/8" NPT	1/8" NPT	#10-32	0.10/2.3
<u>MME-2QDS-</u> P	0.12/6.7	<u>MME-3QDS-</u> P E	1/4" NPT	1/4" NPT	#10-32	0.10/2.3

\*\* Stacking Valve

\* scfm based on flow @ 100 psig

Add Electrical Connection and Voltage Choices to the end of each Base Part Number - Example: MME-2QDS-W220



# MAXIMATIC® 3-WAY VALVES

## 2-Position Single & Double Solenoid Valves



MME-33WES-D110



MME-32QEE-D110

Maximatic® 3-way electronic valves are either N.C. single solenoid spring return or double solenoid spool valves in #10-32 to 1/2" NPT port sizes.

**Medium:** Air (40 micron filtration) or Inert Gas

**Operating Range:** 20 to 125 psig

**Electrical Connection:** DIN connector with LED indicator ("-D"), or 18" Wire Lead ("-W")

**Voltage:** 12-volt DC ("-012"), 24-volt DC ("-024"), 24-volt AC ("-24A"), 110-volt AC ("-110"), or 220-volt AC ("-220")

**Number of Ports:** 3

**Mounting:** Body Ported, Manifold Mount, Actuator (1/4" NPT only) or NAMUR (3/8" NPT only) available. See Page 234.

**Manual Override:** Non-locking on MME-31 series. Locking on all other models.

**Power Consumption:** 2.5 Watts on MME-31 series; 3 Watts for all others.

**MAXIMUM**  
Value.  
→ Performance.

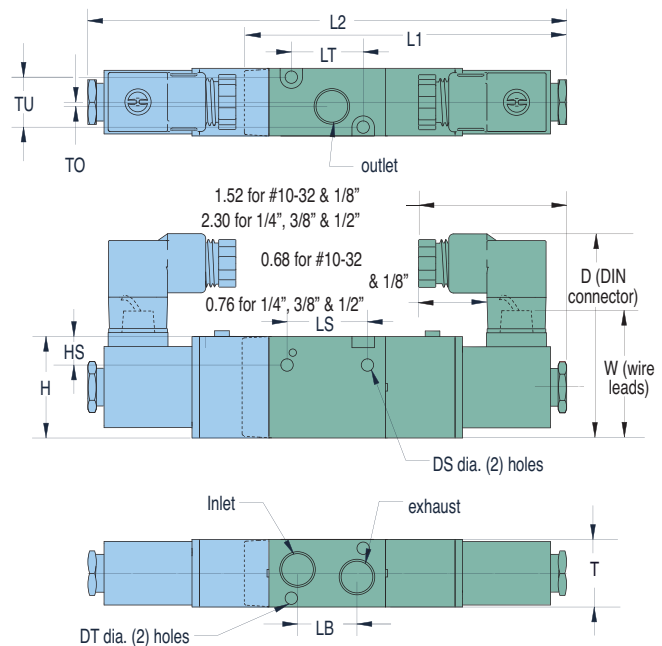

Dim.	MME-31	MME-32	MME-33	MME-34
D	2.14	2.65	2.71	2.94
DS	0.13	0.17	0.17	0.22
DT	0.13	0.13	0.17	0.17
H	1.07	1.38	1.58	1.97
HS	0.30	0.31	0.41	0.53
L1	3.38	4.39	4.70	5.39
L2	5.02	6.49	6.76	7.55
LB	0.63	0.71	0.94	1.42
LS	0.83	0.98	1.18	2.01
LT	0.75	1.30	1.37	1.61
T	0.71	0.87	1.06	1.34
TO	0.06	0.06	0.16	0.16
TU	0.50	0.65	0.80	1.07
W	1.32	1.51	1.54	1.73

Single Solenoid Valves		Double Solenoid Valves		Inlet	Outlet	Exhaust	Cv/scfm*
<u>MME-31NES-</u>		<u>MME-31NEE-</u>		#10-32	#10-32	#10-32	0.58/27
<u>MME-31PES-</u>		<u>MME-31PEE-</u>		1/8" NPT	1/8" NPT	1/8" NPT	0.67/31
<u>MME-32QES-</u>		<u>MME-32QEE-</u>		1/4" NPT	1/4" NPT	1/4" NPT	0.89/49
<u>MME-33WES-</u>		<u>MME-33WEE-</u>		3/8" NPT	3/8" NPT	3/8" NPT	1.68/93
<u>MME-34ZES-</u>		<u>MME-34ZEE-</u>		1/2" NPT	1/2" NPT	1/2" NPT	2.79/171

\* scfm based on flow @ 100 psig

Add Electrical Connection and Voltage Choices to the end of each Base Part Number - Example: MME-34ZEE-W024





## 2-Position Single Solenoid Valves

1/4" & 3/8" NAMUR Style



**MME-33WESB-D012**



**MME-32QESB-D220**

Maximatic® 3-way and 4-way single solenoid spring return pool valves are also available in 1/4" NPT actuator mount or 3/8" NAMUR mount.

**Medium:** Air (40 micron filtration) or Inert Gas

**Operating Range:** 20 to 125 psig

**Electrical Connection:** DIN terminal with LED indicator ("-D"), or Grommet with 18" Wire Lead ("-W")

**Voltage:** 12-volt DC ("-012"), 24-volt DC ("-024"), 24-volt AC ("-24A"), 110-volt AC ("-110"), or 220-volt AC ("-220")

**Number of Ports:** 3 or 5

**Mounting:** Actuator (1/4" NPT only) or NAMUR (3/8" NPT only).

**Manual Override:** Locking

**Power Consumption:** 3 Watts

NAMUR/Actuator mount available on other 3- and 4-way Electronic and Air Pilot valves—  
Call for specifications.

### 3-Way Solenoid Valves

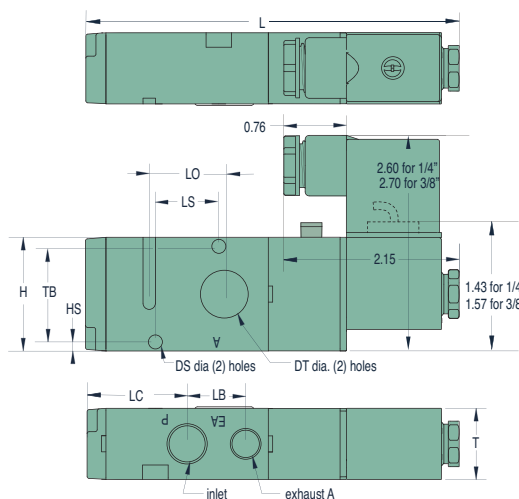

Dim.	1/4" NPT	3/8" NPT
DS	0.17	0.22
DT	0.72	0.78
H	1.38	1.58
HS	0.09	0.15
L	4.49	5.19
LC	1.21	1.57
LB	0.71	0.94
LO	0.9	0.94
LS	0.79	0.94
T	0.86	1.06
TB	1.14	1.26

### 4-Way Solenoid Valves

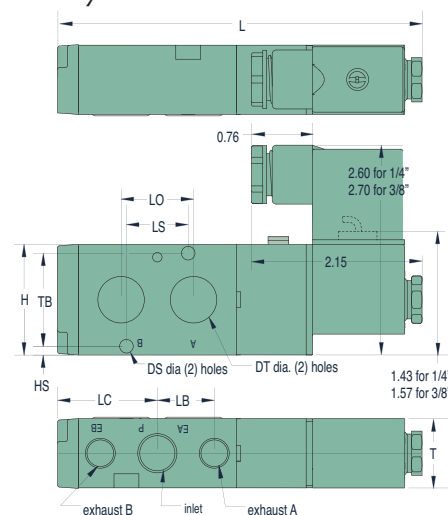

#### 3-Way Single Solenoid Valves

**MME-32QESB-**  
**MME-33WESB-**



#### Supply Port

1/4" NPT  
3/8" NPT

#### Outlet

0.72"  
0.78"

#### Exhaust

1/4" NPT  
1/4" NPT

#### Cv/scfm\*

0.89/49  
1.68/93

#### 4-Way Single Solenoid Valves

**MME-42QESB-**  
**MME-43WESB-**

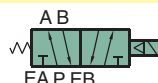

#### Supply Port

1/4" NPT  
3/8" NPT

#### Outlet

0.72"  
0.78"

#### Exhaust

1/4" NPT  
1/4" NPT

#### Cv/scfm\*

0.89/49  
1.68/93

\* scfm based on flow @ 100 psig

Add Electrical Connection and Voltage Choices to the end of each Base Part Number - Example: **MME-42QESB-D110**



# MAXIMATIC® 4-WAY VALVES

## 2-Position Single & Double Solenoid Valves



Maximatic® 4-way solenoid controlled pilot operated valves are either single solenoid spring return or double solenoid spool valves in #10-32 thread to 1/2" NPT port sizes.

**Medium:** Air (40 micron filtration) or Inert Gas

**Operating Range:** 20 to 125 psig

**Electrical Connection:** DIN connector with LED indicator ("-D"), or 18" Wire Lead ("-W")

**Voltage:** 12-volt DC ("-012"), 24-volt DC ("-024"), 24-volt AC ("-24A"), 110-volt AC ("-110"), or 220-volt AC ("-220")

**Number of Ports:** 5

**Mounting:** Body Ported, Manifold Mount

**Manual Override:** Non-locking on MME-41 models. Locking on all other models.

**Power Consumption:** 2.5 Watts on MME-41 models; 3 Watts for all others.

Dim.	MME-41	MME-42	MME-43	MME-44
D	2.14	2.65	2.71	2.94
DS	0.13	0.17	0.17	0.21
DT	0.13	0.13	0.17	0.17
H	1.07	1.38	1.58	1.97
HS	0.16	0.28	0.26	0.29
L1	3.81	4.49	5.19	6.39
L2	5.54	6.49	7.24	8.48
LE	1.09	1.42	1.77	2.48
LO	0.63	0.74	0.96	1.42
LS	0.56	0.98	0.95	1.11
LT	1.18	1.40	1.97	2.82
T	0.71	0.86	1.06	1.34
TU	0.11	0.13	0.16	0.19
TU	0.50	0.65	0.80	1.07
W	1.32	1.51	1.54	1.73

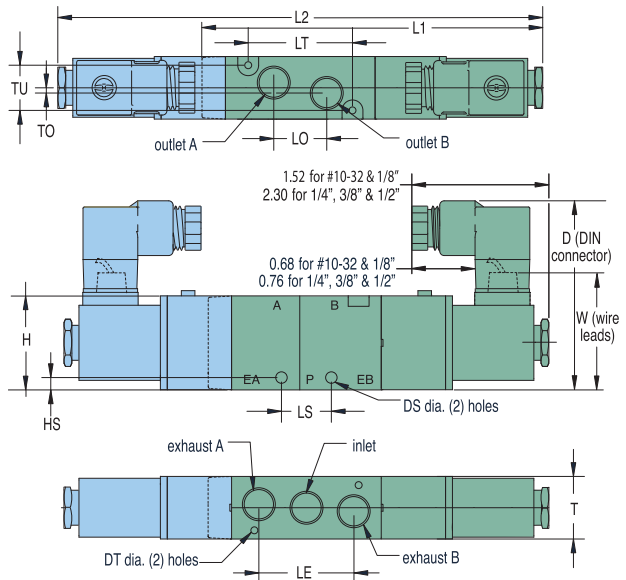

Single Solenoid Valves		Double Solenoid Valves		Inlet	Outlet	Exhaust	Cv/scfm*
<u>MME-41NES-</u>		<u>MME-41NEE-</u>		#10-32	#10-32	#10-32	0.58/27
<u>MME-41PES-</u>		<u>MME-41PEE-</u>		1/8" NPT	1/8" NPT	1/8" NPT	0.67/31
<u>MME-42QES-</u>		<u>MME-42QEE-</u>		1/4" NPT	1/4" NPT	1/8" NPT	0.89/49
<u>MME-43WES-</u>		<u>MME-43WEE-</u>		3/8" NPT	3/8" NPT	1/4" NPT	1.68/93
<u>MME-44ZES-</u>		<u>MME-44ZEE-</u>		1/2" NPT	1/2" NPT	1/2" NPT	2.79/171

\* scfm based on flow @ 100 psig

Add Electrical Connection and Voltage Choices to the end of each Base Part Number - Example: **MME-43WEE-D110**

## 3-Position Spring Centered Double Solenoid Valves



**MME-44ZEEC-D024**

Maximatic® 4-way double solenoid spring centered valves with closed center, pressure center, pressure center or exhaust center spools are available from #10-32 thread to 1/2" NPT port sizes.

**Medium:** Air (40 micron filtration) or Inert Gas

**Operating Range:** 30 to 125 psig on MME-41 series, 20 to 125 psig on all others

**Electrical Connection:** DIN terminal with LED indicator ("D"), or 18" Wire Lead ("W")

**Voltage:** 12-volt DC ("-012"), 24-volt DC ("-024"), 24-volt AC ("-24A"), 110-volt AC ("-110"), or 220-volt AC ("-220")

**Number of Ports:** 5

**Mounting:** Body Ported, Manifold Mount

**Manual Override:** Non-locking on MME-41 Series. Locking on all other models.

**Power Consumption:** 2.5 Watts on MME-41 models; 3 Watts for all others.

Dim.	MME-41	MME-42	MME-43	MME-44
D	2.14	2.65	2.71	2.94
DS	0.13	0.17	0.17	0.21
DT	0.13	0.13	0.17	0.17
H	1.07	1.38	1.58	1.97
HS	0.16	0.28	0.26	0.29
L	6.13	7.24	7.98	8.48
LE	1.09	1.42	1.77	2.48
LO	0.63	0.74	0.96	1.42
LS	0.56	0.98	0.95	1.11
LT	1.18	1.40	1.97	2.82
T	0.71	0.86	1.06	1.34
TO	0.11	0.13	0.16	0.19
TU	0.50	0.65	0.80	1.07
W	1.32	1.51	1.54	1.73

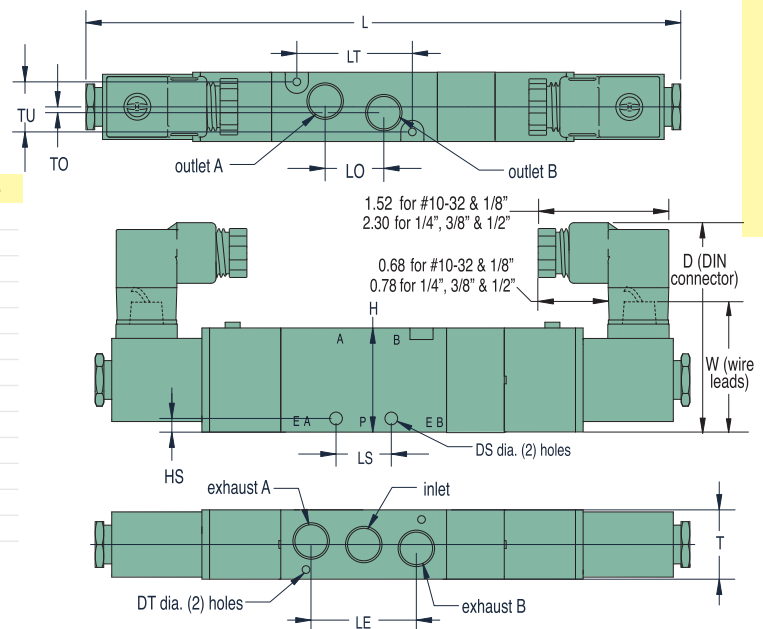

Closed Center	Pressure Center	Exhaust Center	Inlet	Outlet	Exhaust	Cv/scfm*
<u>MME-41NEEC-</u>	<u>MME-41NEEP-</u>	<u>MME-41NEEE-</u>	#10-32	#10-32	#10-32	0.50/23
<u>MME-41PEEC-</u>	<u>MME-41PEEP-</u>	<u>MME-41PEEE-</u>	1/8" NPT	1/8" NPT	1/8" NPT	0.50/23
<u>MME-42QEEC-</u>	<u>MME-42QEEP-</u>	<u>MME-42QEEE-</u>	1/4" NPT	1/4" NPT	1/8" NPT	0.89/49
<u>MME-43WEEC-</u>	<u>MME-43WEEP-</u>	<u>MME-43WEEE-</u>	3/8" NPT	3/8" NPT	1/4" NPT	1.00/72
<u>MME-44ZEEC-</u>	<u>MME-44ZEEP-</u>	<u>MME-44ZEEE-</u>	1/2" NPT	1/2" NPT	1/2" NPT	1.68/93

\* scfm based on flow @ 100 psig

Add Electrical Connection and Voltage Choices to the end of each Base Part Number - Example: **MME-41PEEP-W024**