



# HIGH FLOW 2-WAY 10 MM MINIATURE VALVES

## Specifications

**Medium:** Air, Gas or other Compatible Fluids

**Working Pressure:** 0 to 30 psig

**Max. Flow Rate:** 28 lpm

**Orifice:** 0.055"

**Response Time:** 8 ms when energized; 10 ms when de-energized

**Electrical:** 12 VDC or 24 VDC

**Power Consumption:** 3.5 watts in rush phase; 15 ms/0.35 watts in maintenance phase

**Voltage Tolerance:** -5% to +10%

**Material:** Stainless steel core and springs, nylon body, FKM dynamic seals, and Nitrile gasket and static seals.

**Temperature Range:** 23 to 122°F. When below 32°F, must use clean, dry air



### 90° Connector with LED

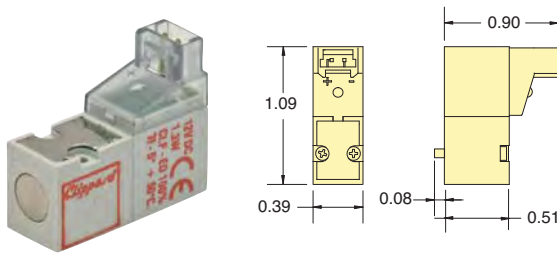

### In-Line Connector with LED

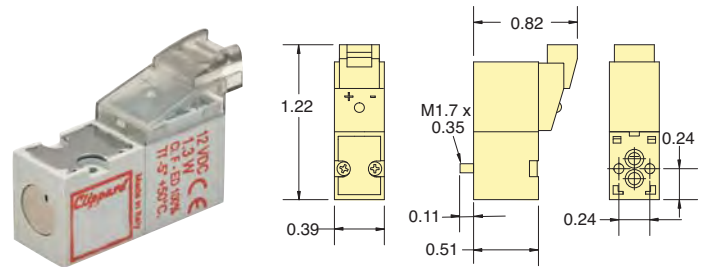

| Part No.                    | Connector                  | Voltage |
|-----------------------------|----------------------------|---------|
| <a href="#">E210H-3L012</a> | 90° Connector with LED     | 12 VDC  |
| <a href="#">E210H-3L024</a> |                            | 24 VDC  |
| <a href="#">E210H-3C012</a> | In-Line Connector with LED | 12 VDC  |
| <a href="#">E210H-3C024</a> |                            | 24 VDC  |

### Typical Air Flow

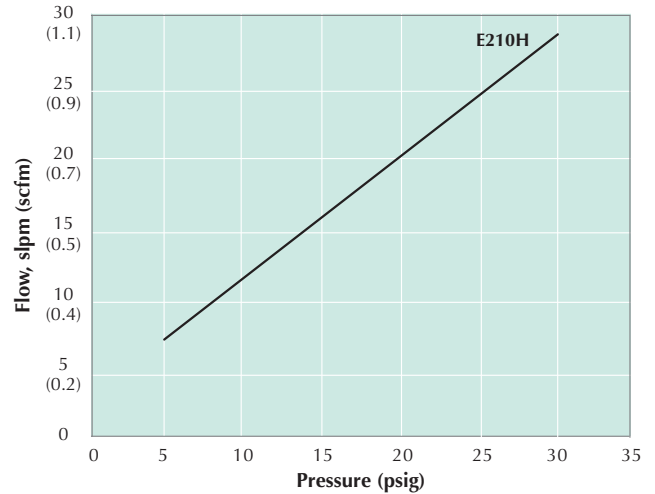

### Mounting Interface

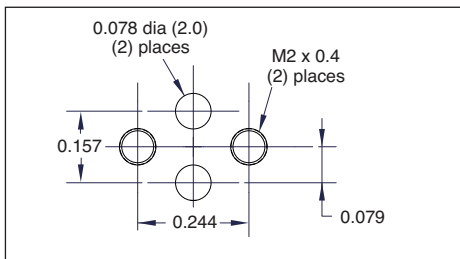

### 10 mm High Flow Single-Station Manifold

Spare hardware and closing plates available.

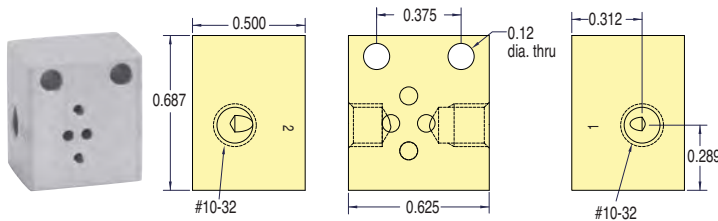

| Part No.                 | Description                   |
|--------------------------|-------------------------------|
| <a href="#">E10HM-01</a> | 10 mm Single-Station Manifold |

### Functional Schematics

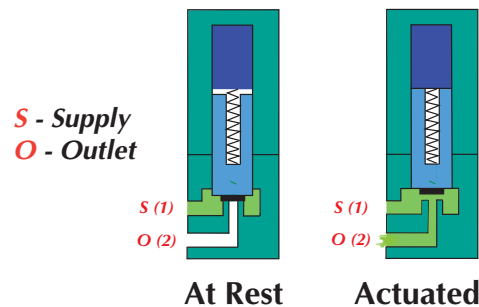

## Specifications

**Medium:** Air, Gas, or other Compatible Fluids

**Working Pressure:** 0 to 102 psig

**Maximum Flow Rate:** 42 l/min

**Exhaust Flow:** 49 l/min

**Orifice:** 0.043"

**Response Time:** 8 ms when energized; 10 ms when de-energized

**Material:** Stainless steel core and springs, nylon body, FKM seals, and Nitrile gasket.

**Voltage:** 12-volt DC or 24-volt DC

**Voltage Tolerance:** -5% to +10%

**Power Consumption:** 3.5 watts in rush phase; 15 ms/0.35 watts in maintenance phase

**Coil Insulation Class:** F 311°F

**Temperature Range:** 23 to 122°F



### 90° Connector with LED

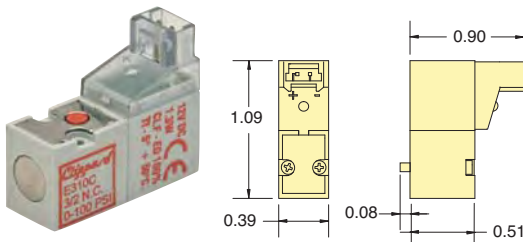

### In-Line Connector with LED

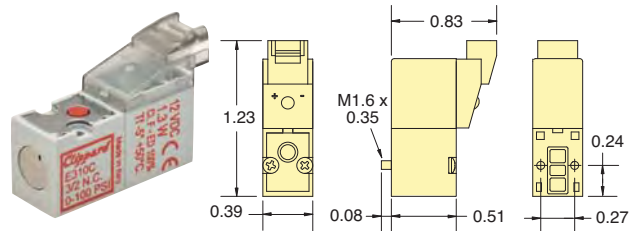

| Part No.                    | Connector         | Voltage |
|-----------------------------|-------------------|---------|
| <a href="#">E311E-3L012</a> | 90° Connector     | 12 VDC  |
| <a href="#">E311E-3L024</a> | with LED          | 24 VDC  |
| <a href="#">E311E-3C012</a> | In-Line Connector | 12 VDC  |
| <a href="#">E311E-3C024</a> | with LED          | 24 VDC  |

### Mounting Interface

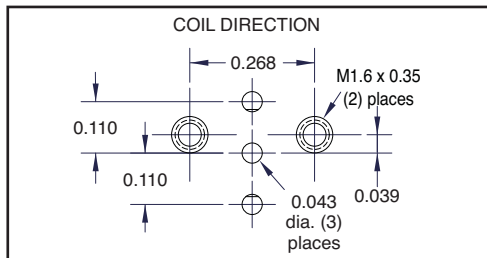

### Typical Air Flow

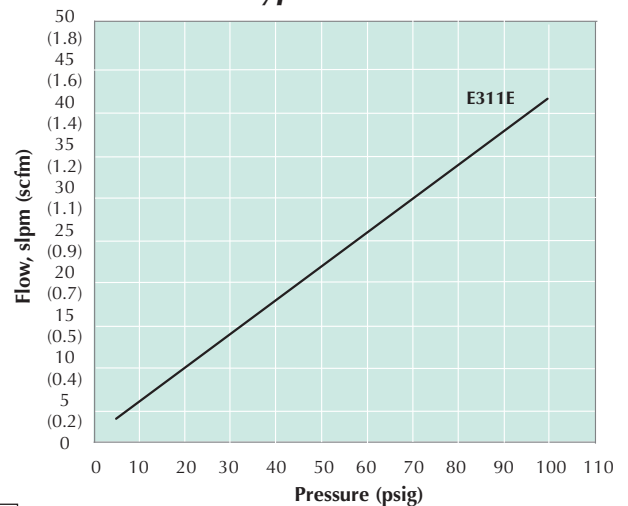

## ISO 15218 10 mm High Flow Single-Station Manifold

Spare hardware and closing plates available.

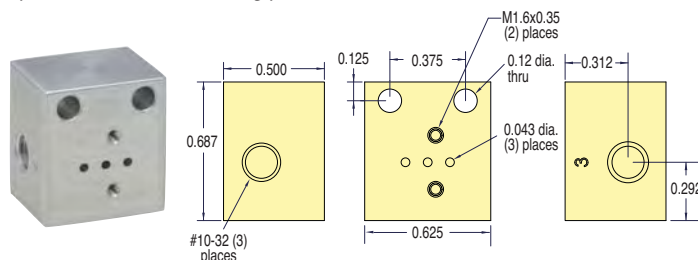

| Part No.                 | Description                       |
|--------------------------|-----------------------------------|
| <a href="#">E10LM-01</a> | ISO 10 mm Single-Station Manifold |

### Functional Schematics

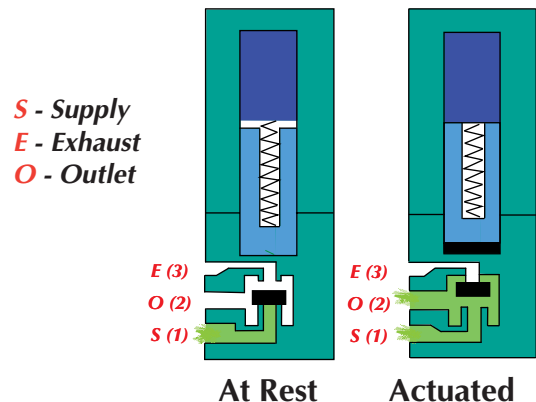



# 10 MM MINIATURE VALVE ACCESSORIES

## Sub-Miniature Manifolds

Small, compact manifolds offer the efficient grouping of 10 mm valves along with fast installation. Easy manifold features a common inlet, individually-ported outlets, and exhaust to atmosphere.

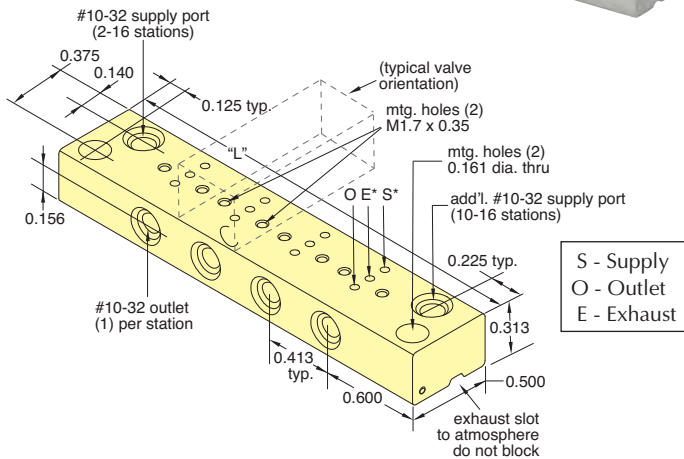

\* For Normally-Open valves, supply to "E" and "S" becomes exhaust.

| Stations | Supply Ports | Part No.                 | Length "L" |
|----------|--------------|--------------------------|------------|
| 2        | 1            | <a href="#">E10SM-02</a> | 1.61       |
| 4        | 1            | <a href="#">E10SM-04</a> | 2.44       |
| 6        | 1            | <a href="#">E10SM-06</a> | 3.27       |
| 8        | 1            | <a href="#">E10SM-08</a> | 4.09       |
| 10       | 2            | <a href="#">E10SM-10</a> | 4.92       |
| 12       | 2            | <a href="#">E10SM-12</a> | 5.74       |
| 14       | 2            | <a href="#">E10SM-14</a> | 6.57       |
| 16       | 2            | <a href="#">E10SM-16</a> | 7.40       |

## Cover Plate

Manifold Cover Plate includes plate, gasket and two screws.

**Part No.**  
[E10M-CP](#) 10 mm Cover Plate

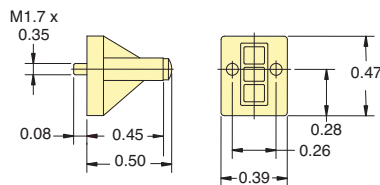

## Standard Manifolds

Standard manifolds are available for one to 12 valves with ported exhaust. Spare hardware and closing plates available.

**Part No.**  
[E10M-01](#) Single-Station Manifold

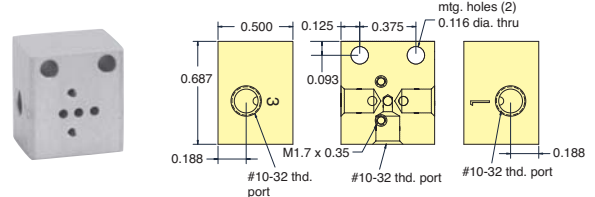

## Multi-Station Manifolds

When using these manifolds with Normally-Closed valve configurations:

1. They cannot be used with Normally-Closed valves on the same manifold.
2. "E" becomes Supply, and "S" becomes Exhaust.

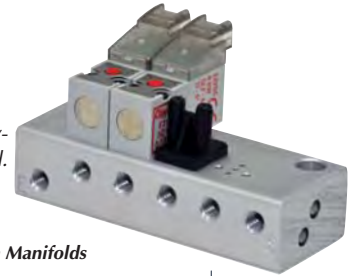

### 10- to 16-Station Manifolds

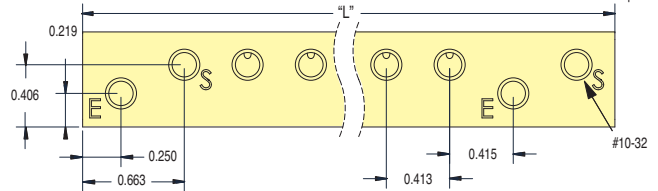
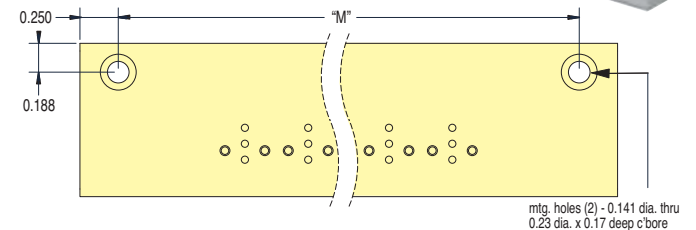

### 2- to 8-Station Manifolds

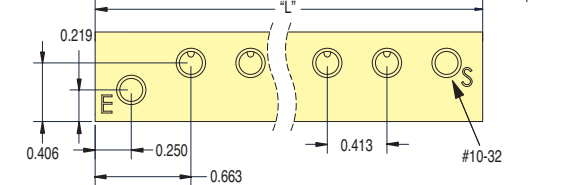
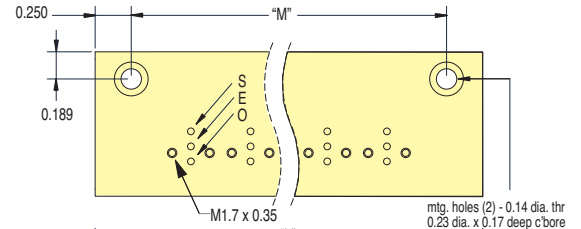

| Part No.                | Stations | Length "L" | Length "M" |
|-------------------------|----------|------------|------------|
| <a href="#">E10M-02</a> | 2        | 1.74       | 1.24       |
| <a href="#">E10M-04</a> | 4        | 2.57       | 2.07       |
| <a href="#">E10M-06</a> | 6        | 3.39       | 2.89       |
| <a href="#">E10M-08</a> | 8        | 4.22       | 3.72       |
| <a href="#">E10M-10</a> | 10       | 5.87       | 5.37       |
| <a href="#">E10M-12</a> | 12       | 6.70       | 6.20       |
| <a href="#">E10M-14</a> | 14       | 7.52       | 7.02       |
| <a href="#">E10M-16</a> | 16       | 8.35       | 7.85       |

# 15 MM MINIATURE VALVES



- Multiple Connectors
- Snap-in Plugs
  - Wire Leads
  - DIN Connector
  - Spade Terminals
  - Custom Plugs

LED for confirmation of operation available

Internal diodes for current spike suppression and a power saving circuit is available



Mounting Screws

HIGHLY VISIBLE manual override provides valve actuation without power

High durability and corrosion-resistant glass filled nylon housing

FKM seals and Nitrile gasket

2- or 3-ported valves in Normally-Closed and Normally-Open

One-piece gasket for manifold mount and supply/exhaust port reversed for same manifold mounting of N.O. or N.C. valve



Encapsulated low wattage coils. Available in: 12 VDC, 24 VDC, 24 VAC, 110 VAC or 220 VAC. Special voltages available for OEMs.

| Configuration | 1       | 2      | 3      |
|---------------|---------|--------|--------|
| N.C. & N.O.   | exhaust | outlet | supply |

## Functional Schematics

### Normally-Closed 3-Way Valve

S - Supply  
E - Exhaust  
O - Outlet

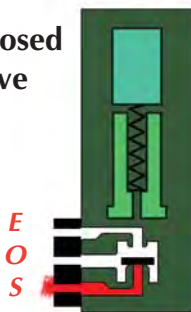

At Rest

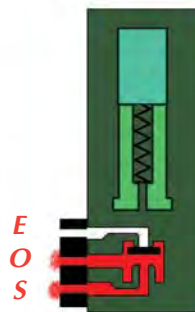

Actuated

### Normally-Open 3-Way Valve

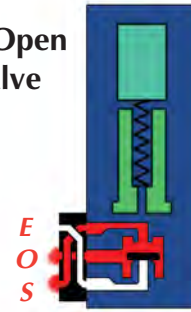

At Rest

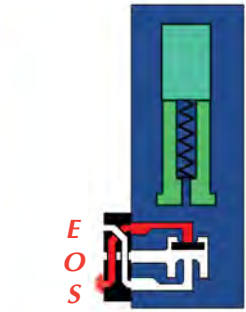

Actuated



### Porting Gasket

The Normally-Open and Normally-Closed configurations allow both models to be mounted on the same manifold.

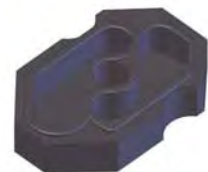



# 15 MM MINIATURE VALVES

## Specifications

**Medium:** Air, Gas, or other Compatible Fluids

**Working Pressure:** See Chart below.

**Maximum Flow Rate:**  
 0.032" Orifice: 45 l/min  
 0.043" Orifice: 70 l/min  
 0.063" Orifice: 91 l/min

**Response Time:** 10 ms when energized; 12 ms when de-energized



**Material:** Stainless steel core and springs, springs, nylon body, FKM seals, and Nitrile gasket.

**Voltage:** 12-volt DC, 24-volt DC or 24-volt AC. 110-volt AC and 220-volt AC only available with DIN Connectors.

**Voltage Tolerance:** -5% to +10%

**Power Consumption:** 1.0 or 2.5 watts dependent on orifice size and pressure

**Coil Insulation Class:** F 311°F

**Temperature Range:** 23 to 122°F



## Order Information

| Type   | Base No.                   | Connector              | 12  | 24  | 24  | 110 | 220    | Orifice | Wattage       | Working Pressure |
|--|----------------------------|------------------------|-----|-----|-----|-----|--------|---------|---------------|------------------|
|  |                            |                        | VDC | VDC | VAC | VAC | VAC    |         |               |                  |
| <b>2/2 Normally-Closed</b><br>               | E215D-1T*                  | Terminal               | •   | •   |     |     |        | 0.032"  | 1.0           | 0 to 150 psig    |
|  | E215E-2T*                  |                        | •   | •   | •   |     |        | 0.043"  | 2.5           | 0 to 150 psig    |
|  | E215F-2T*                  |                        | •   | •   | •   |     |        | 0.063"  | 2.5           | 0 to 110 psig    |
|  | E215D-1D*                  | DIN Connector          | •   | •   |     |     |        | 0.032"  | 1.0           | 0 to 150 psig    |
|  | E215E-2D*                  |                        | •   | •   | •   | •   | •      | 0.043"  | 2.5           | 0 to 150 psig    |
|  | E215F-2D*                  |                        | •   | •   | •   | •   | •      | 0.063"  | 2.5           | 0 to 110 psig    |
|  | E215D-1W*                  | Wire Leads, 11.8"      | •   | •   |     |     |        | 0.032"  | 1.0           | 0 to 150 psig    |
|  | E215E-2W*                  |                        | •   | •   | •   |     |        | 0.043"  | 2.5           | 0 to 150 psig    |
|  | E215F-2W*                  |                        | •   | •   | •   |     |        | 0.063"  | 2.5           | 0 to 110 psig    |
|  | E215D-1L*                  | 90° Connector with LED | •   | •   |     |     |        | 0.032"  | 1.0           | 0 to 150 psig    |
|  | E215E-2L*                  |                        | •   | •   |     |     |        | 0.043"  | 2.5           | 0 to 150 psig    |
|  | E215F-2L*                  |                        | •   | •   |     |     |        | 0.063"  | 2.5           | 0 to 110 psig    |
| E215D-1C*                                    | In-Line Connector with LED | •                      | •   |     |     |     | 0.032" | 1.0     | 0 to 150 psig |                  |
| E215E-2C*                                    |                            | •                      | •   |     |     |     | 0.043" | 2.5     | 0 to 150 psig |                  |
| E215F-2C*                                    |                            | •                      | •   |     |     |     | 0.063" | 2.5     | 0 to 110 psig |                  |
| <b>3/2 Normally-Closed</b><br>               | E315D-1T*                  | Terminal               | •   | •   |     |     |        | 0.032"  | 1.0           | 0 to 150 psig    |
|  | E315E-2T*                  |                        | •   | •   | •   |     |        | 0.043"  | 2.5           | 0 to 150 psig    |
|  | E315F-2T*                  |                        | •   | •   | •   |     |        | 0.063"  | 2.5           | 0 to 110 psig    |
|  | E315D-1D*                  | DIN Connector          | •   | •   |     |     |        | 0.032"  | 1.0           | 0 to 150 psig    |
|  | E315E-2D*                  |                        | •   | •   | •   | •   | •      | 0.043"  | 2.5           | 0 to 150 psig    |
|  | E315F-2D*                  |                        | •   | •   | •   | •   | •      | 0.063"  | 2.5           | 0 to 110 psig    |
|  | E315D-1W*                  | Wire Leads, 11.8"      | •   | •   |     |     |        | 0.032"  | 1.0           | 0 to 150 psig    |
|  | E315E-2W*                  |                        | •   | •   | •   |     |        | 0.043"  | 2.5           | 0 to 150 psig    |
|  | E315F-2W*                  |                        | •   | •   | •   |     |        | 0.063"  | 2.5           | 0 to 110 psig    |
|  | E315D-1L*                  | 90° Connector with LED | •   | •   |     |     |        | 0.032"  | 1.0           | 0 to 150 psig    |
|  | E315E-2L*                  |                        | •   | •   |     |     |        | 0.043"  | 2.5           | 0 to 150 psig    |
|  | E315F-2L*                  |                        | •   | •   |     |     |        | 0.063"  | 2.5           | 0 to 110 psig    |
| E315D-1C*                                    | In-Line Connector with LED | •                      | •   |     |     |     | 0.032" | 1.0     | 0 to 150 psig |                  |
| E315E-2C*                                    |                            | •                      | •   |     |     |     | 0.063" | 2.5     | 0 to 150 psig |                  |
| E315F-2C*                                    |                            | •                      | •   |     |     |     | 0.063" | 2.5     | 0 to 110 psig |                  |
| <b>3/2 Normally-Open (110 psig max.)</b><br> | E3O15E-2T*                 | Terminal               | •   | •   | •   |     |        | 0.043"  | 2.5           | 0 to 110 psig    |
|  | E3O15F-2T*                 |                        | •   | •   | •   |     |        | 0.063"  | 2.5           | 0 to 75 psig     |
|  | E3O15E-2D*                 | DIN Connector          | •   | •   | •   | •   | •      | 0.043"  | 2.5           | 0 to 110 psig    |
|  | E3O15F-2D*                 |                        | •   | •   | •   | •   | •      | 0.063"  | 2.5           | 0 to 75 psig     |
|  | E3O15E-2W*                 | Wire Leads, 11.8"      | •   | •   | •   |     |        | 0.043"  | 2.5           | 0 to 110 psig    |
|  | E3O15F-2W*                 |                        | •   | •   | •   |     |        | 0.063"  | 2.5           | 0 to 75 psig     |
|  | E3O15E-2L*                 | 90° Connector with LED | •   | •   |     |     |        | 0.043"  | 2.5           | 0 to 110 psig    |
|  | E3O15F-2L*                 |                        | •   | •   |     |     |        | 0.063"  | 2.5           | 0 to 75 psig     |
| E3O15E-2C*                                   | In-Line Connector with LED | •                      | •   |     |     |     | 0.063" | 2.5     | 0 to 110 psig |                  |
| E3O15F-2C*                                   |                            | •                      | •   |     |     |     | 0.063" | 2.5     | 0 to 75 psig  |                  |

• Indicates standard items

\* Add Voltage Choice to the end of each Base Part Number. "012" (12 VDC), "024" (24 VDC) "24A" (24 VAC), "110" (110 VAC) or "220" (220 VAC). Example: **E315D-1C012**



# 15 MM MINIATURE VALVES



## Terminal Connector



Industrial Form C Connector ordered separately below.

## DIN Connector



DIN Connector ordered separately below.

## In-Line Connector with LED



## Wire Leads

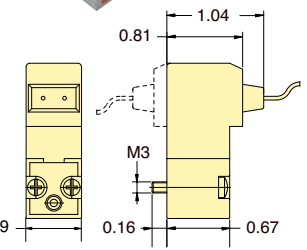
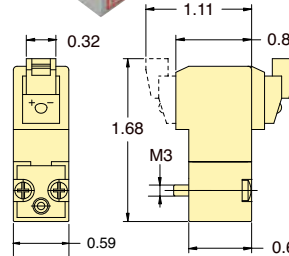
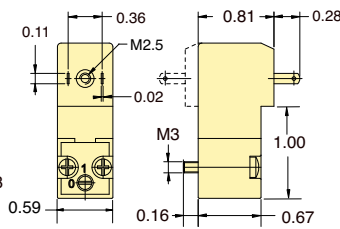
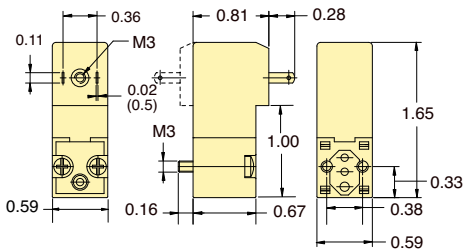

## 90° Connector with LED

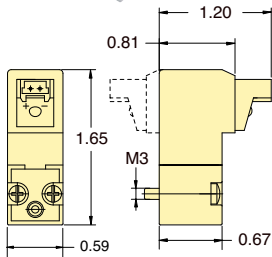

## Typical Air Flow

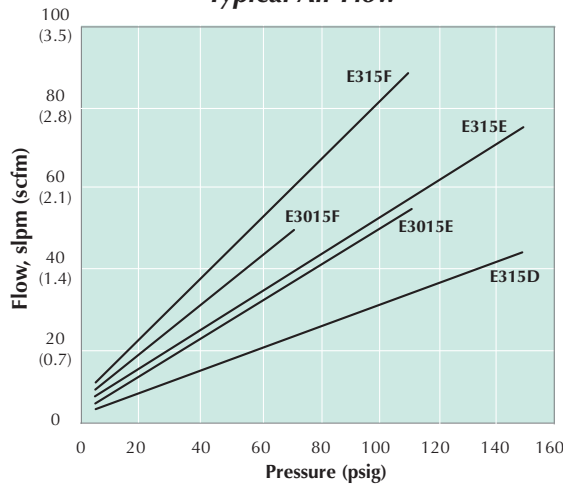

## Mounting Interface

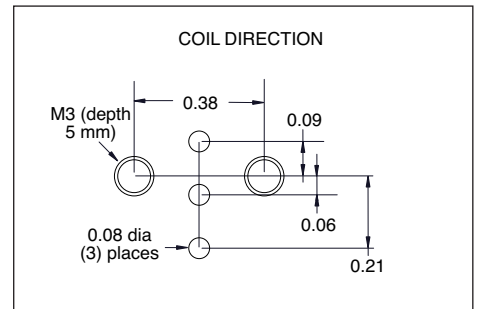

## DIN Connectors

### For Use with 15 mm Valves Only

DIN 43650 Form C Connectors with 8 mm spade center spacing mate with the 15 mm DIN connector coil. Industrial Form Connectors with 9.4 mm spade center spacing are designed to connect to 15 mm terminal coils. Both are available with or without surge suppression, and 152 or 381 mm PVC molded three-wire cord set.

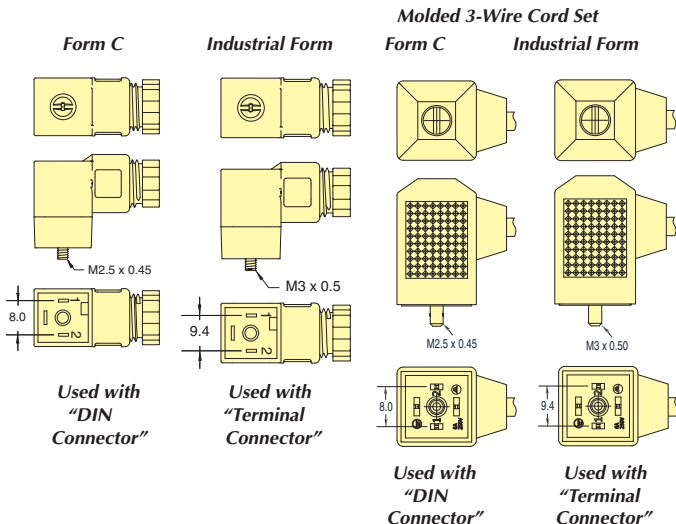

| Form C Part No. | Industrial Form Part No. | Volts  | LED | Cord |
|-----------------|--------------------------|--------|-----|------|
| CC-C            | CC-I                     | 6-240  | no  | -    |
| CC-C-P6         | CC-I-P6                  | 6-240  | no  | 6'   |
| CC-C-P15        | CC-I-P15                 | 6-240  | no  | 15'  |
| CC-CLL          | CC-ILL                   | 6-24   | yes | -    |
| CC-CLL-P6       | CC-ILL-P6                | 6-24   | yes | 6'   |
| CC-CLL-P15      | CC-ILL-P15               | 6-24   | yes | 15'  |
| CC-CLM          | CC-ILM                   | 48-110 | yes | -    |
| CC-CLM-P6       | CC-ILM-P6                | 48-110 | yes | 6'   |
| CC-CLM-P15      | CC-ILM-P15               | 48-110 | yes | 15'  |



# LATCHING 15 MM MINIATURE VALVES



- 2-Way & 3-Way Normally-Closed configurations
- Pulse-actuated (on or off)
- 3-wire coil. No polarity reverse required
- Stable latch

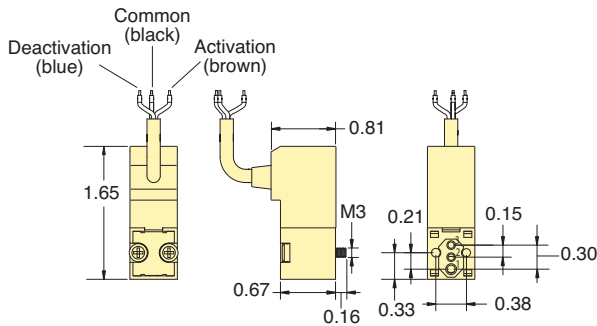

Clippard's 15 mm Latching Valves have many of the same features as the popular 15 mm standard valve line including small, compact design, exceptional life and reliability, light-weight design and more. A careful balance of forces—through the precise placement of a permanent magnet in the valve core—produces a bi-stable valve. A short pulse of current opens the valve, which “latches” open indefinitely after the current stops. A subsequent pulse of current in the opposite direction closes the valve. The valve consumes less energy and produces less heat than a standard solenoid valve when used in extended duty cycle applications, since the coil is energized for only a small fraction of the total duty cycle.

**Medium:** Air, Gas or other Compatible Fluids

**Max. Flow Rate:** 0.043" Orifice: 59 l/min  
0.063" Orifice: 84 l/min

**Electrical Connection:** 3-Wire Molded Cord, 300 mm, 24 AWG 4.5 mm external jacket; tinned copper wires; silicone jacket and conductor insulation)

**Electrical:** 12 VDC (“-012”) or 24 VDC (“-024”). 6 VDC also available. Call for further information.

**Electrical Tolerance:** -5 to +10%



**Response Time:** 10 ms when energized; 12 ms when de-energized

**Copper Wire Isolation Class:** F 311°F

**Material:** Stainless steel core and springs, nylon body, FKM dynamic seals, and Nitrile gasket and static seals.

**Temperature Range:** 23 to 122°F. When below 32°F, must use clean, dry air

## Mounting Interface

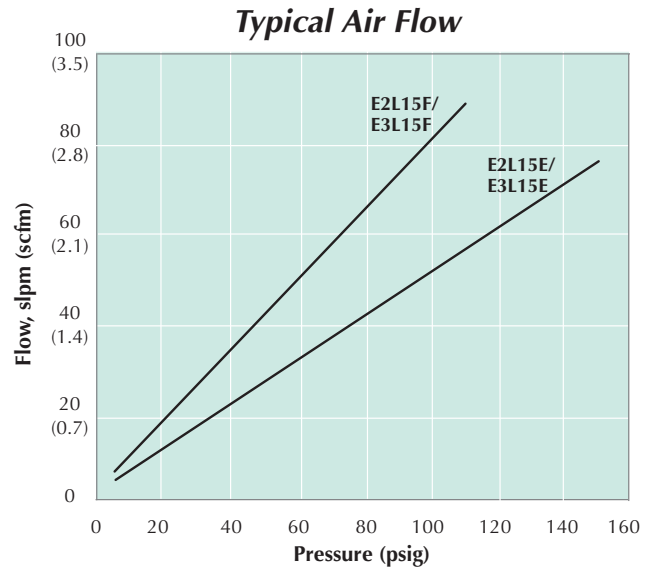
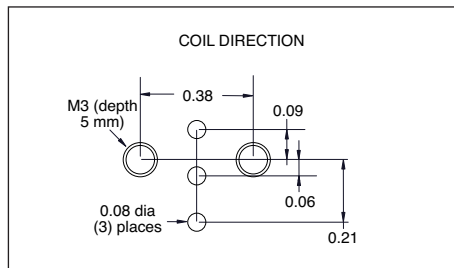

| Type  | Part No.                     | Connector                     | Orifice | Voltage | Wattage | Pressure Range |
|-------|------------------------------|-------------------------------|---------|---------|---------|----------------|
| 2-Way | <a href="#">E2L15E-4W012</a> | 3-Wire Molded Cord,<br>300 mm | 0.043"  | 12 VDC  | 4.0     | 0 to 150 psig  |
|       | <a href="#">E2L15E-4W024</a> |                               | 0.043"  | 24 VDC  |         | 0 to 150 psig  |
|       | <a href="#">E2L15F-4W012</a> |                               | 0.063"  | 12 VDC  |         | 0 to 110 psig  |
|       | <a href="#">E2L15F-4W024</a> |                               | 0.063"  | 24 VDC  |         | 0 to 110 psig  |
| 3-Way | <a href="#">E3L15E-4W012</a> | 3-Wire Molded Cord,<br>300 mm | 0.043"  | 12 VDC  | 4.0     | 0 to 150 psig  |
|       | <a href="#">E3L15E-4W024</a> |                               | 0.043"  | 24 VDC  |         | 0 to 150 psig  |
|       | <a href="#">E3L15F-4W012</a> |                               | 0.063"  | 12 VDC  |         | 0 to 110 psig  |
|       | <a href="#">E3L15F-4W024</a> |                               | 0.063"  | 24 VDC  |         | 0 to 110 psig  |

See [page 214](#) for connectors and manifolds

# HIGH FLOW 2-WAY N.C. 15 MM VALVES



## Specifications

**Medium:** Air, Gas, or other Compatible Fluids

**Working Pressure:** 0 to 43 psig

**Maximum Flow Rate:** 120 l/min

**Orifice:** 0.118"

**Material:** Stainless steel core and springs, nylon body, FKM seals, and Nitrile gasket.

**Response Time:** 10 ms when energized; 12 ms when de-energized

**Voltage:** 12-volt DC or 24-volt DC

**Voltage Tolerance:** -5% to +10%

**Power Consumption:** 4.0 watts

**Coil Insulation Class:** F 311°F

**Temperature Range:** 23 to 122°F



### 90° Connector with LED

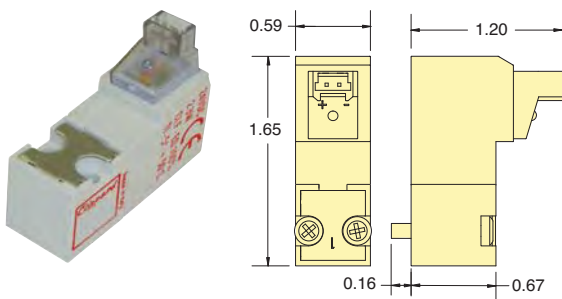

### In-Line Connector with LED

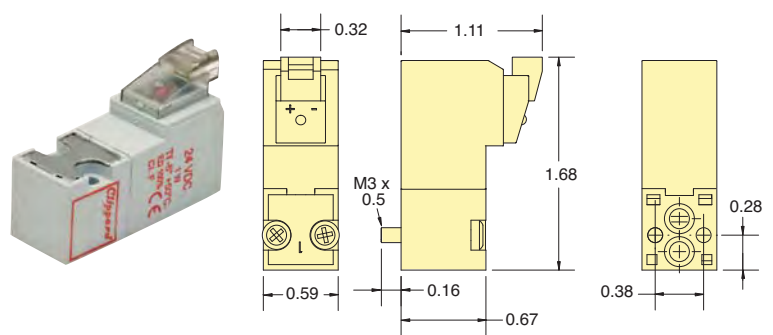

| Part No.                    | Connector                  | Voltage |
|-----------------------------|----------------------------|---------|
| <a href="#">E215H-3L012</a> | 90° Connector              | 12 VDC  |
| <a href="#">E215H-3L024</a> | 90° Connector with LED     | 24 VDC  |
| <a href="#">E215H-3C012</a> | In-Line Connector          | 12 VDC  |
| <a href="#">E215H-3C024</a> | In-Line Connector with LED | 24 VDC  |

### Mounting Interface

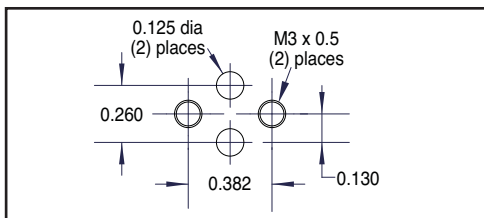

### Typical Air Flow

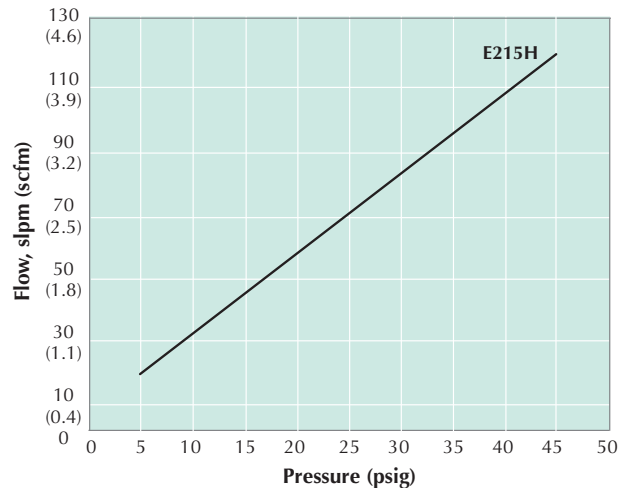

### 15 mm High Flow Single-Station Manifold

Spare hardware and closing plates available.

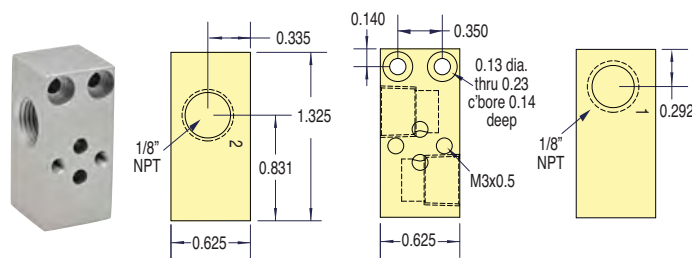

**Part No.**  
[E15HM-01](#) 15 mm Single-Station Manifold

Metric line available. Visit [www.clippard.com](http://www.clippard.com)

### Functional Schematics

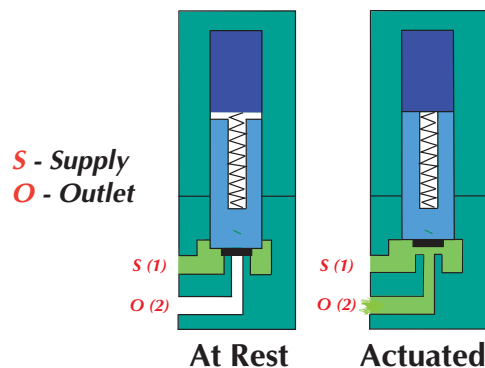





# 15 MM VALVE ACCESSORIES

## Sub-Miniature Manifolds

Small, compact manifolds offer the efficient grouping of 15 mm valves along with fast installation. Each manifold features a common inlet, individually-ported outlets, and exhaust to atmosphere.

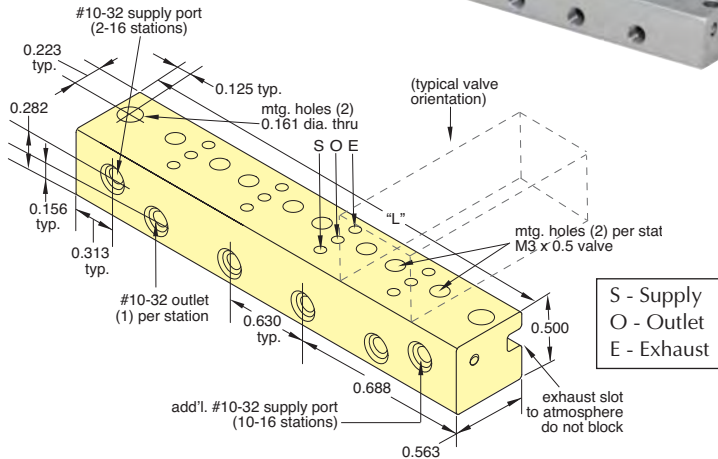
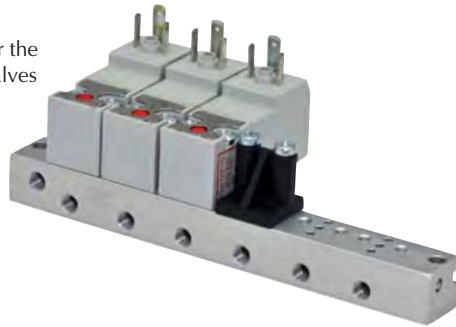

| Stations | Supply Ports | Part No.                 | Length "L" |
|----------|--------------|--------------------------|------------|
| 2        | 1            | <a href="#">E15SM-2</a>  | 2.01       |
| 4        | 1            | <a href="#">E15SM-4</a>  | 3.27       |
| 6        | 1            | <a href="#">E15SM-6</a>  | 4.53       |
| 8        | 1            | <a href="#">E15SM-8</a>  | 5.79       |
| 10       | 2            | <a href="#">E15SM-10</a> | 7.05       |
| 12       | 2            | <a href="#">E15SM-12</a> | 8.31       |
| 14       | 2            | <a href="#">E15SM-14</a> | 9.57       |
| 16       | 2            | <a href="#">E15SM-16</a> | 10.82      |



## Connectors

Wire Connector must be ordered separately. 24 AWG. Stranding 7/32.

### Part No.

- [C2A-RB300](#) Connector with Cable, 11.8"
- [C2A-RB500](#) Connector with Cable, 19.69"
- [C2A-RB1000](#) Connector with Cable, 39.37"

Molex terminal insert #050013-8000, #28139 plug and 24 AWG wire.

## Cover Plate

Manifold Cover Plate includes plate, gasket and two screws.

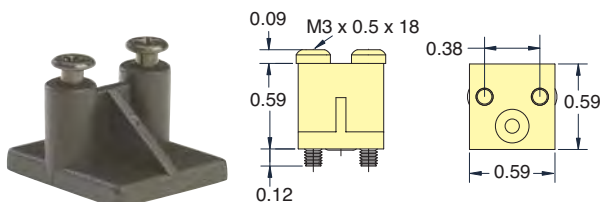

### Part No.

[E15M-CP](#) 15 mm Cover Plate

## Standard Manifolds

Standard manifolds are available for one to 16 valves with ported exhaust. Spare hardware and closing plates also available.

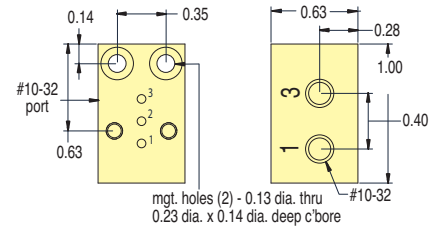

### Part No.

[E15M-01](#) Single-Station Manifold

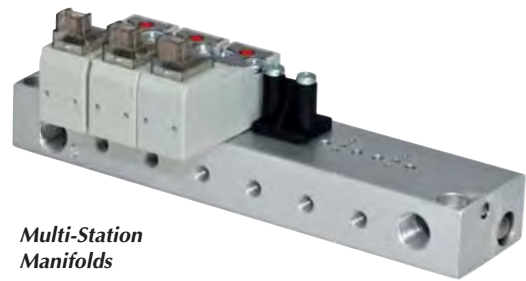

### Multi-Station Manifolds

#### 2- through 8-Station

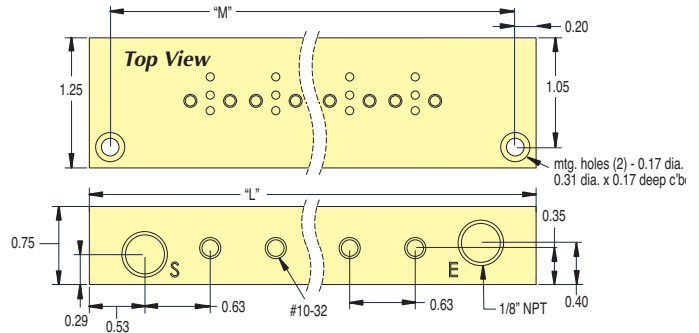

#### 10- through 16-Station

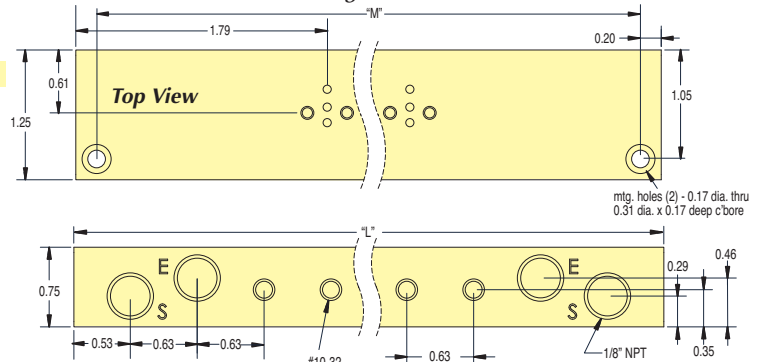

| Stations | Part No.                | Length "L" | Length "M" |
|----------|-------------------------|------------|------------|
| 2        | <a href="#">E15M-02</a> | 2.95       | 2.55       |
| 4        | <a href="#">E15M-04</a> | 4.21       | 3.81       |
| 6        | <a href="#">E15M-06</a> | 5.47       | 5.07       |
| 8        | <a href="#">E15M-08</a> | 6.73       | 6.33       |
| 10       | <a href="#">E15M-10</a> | 9.25       | 8.85       |
| 12       | <a href="#">E15M-12</a> | 10.51      | 10.1       |
| 14       | <a href="#">E15M-14</a> | 11.77      | 11.4       |
| 16       | <a href="#">E15M-16</a> | 13.03      | 12.6       |



# Maximatic®



## Maximatic Solenoid Valves

Clippard's Maximatic Solenoid valves are available in 2-way, 3-way and 4-way configurations in port sizes from #10-32 to 1/2" NPT. Select either a direct-acting poppet or solenoid-controlled pilot operated balanced spool design. Spool valves are body ported but can be bolted to a parallel circuit manifold.

These electronic valves offer high flow in a small package, and are constructed of aluminum, stainless steel and thermoplastic materials. The 4-way valves are also available in 3 position versions with either pressure center, closed center or exhaust center spool options.

**Materials:** Aluminum, Stainless Steel, Thermoplastic

**Maximum Pressure:** 0 to 115 psig (direct-acting only); 30 to 125 on MME-41 Series, 20 to 125 psig on all others (spool valves)

**Response Time:** Less than 20 milliseconds

**Mounting:** Manifold standard. Actuator (1/4" only) or NAMUR (3/8" NPT only) available.

**Manual Override:** Locking or non-locking

**Electrical Connection:** DIN terminal with LED indicator, or 18" Wire Leads

**DIN Connector:** Plug-in electrical connector with LED. MME-31/41 models are DIN Industrial Form "C" (9.4 mm centers) 3 mm screw. All others are DIN 43650 Form "B" 3 mm screw. LED will not "light" if polarity is reversed.

**Wire Leads:** Not polarity sensitive

**Temperature Range:** 32 to 150°F

**Seals:** Nitrile

Conforms to ISO 19973-2 test standards.

3- & 4-Way Valves

| Port     | Cv   | Flow Rate |            |
|----------|------|-----------|------------|
|          |      | @ 50 psig | @ 100 psig |
| #10-32   | 0.58 | 16 scfm   | 27 scfm    |
| 1/8" NPT | 0.67 | 18 scfm   | 31 scfm    |
| 1/4" NPT | 0.89 | 26 scfm   | 49 scfm    |
| 3/8" NPT | 1.68 | 51 scfm   | 93 scfm    |
| 1/2" NPT | 2.79 | 91 scfm   | 171 scfm   |

Metric line available. Visit [www.clippard.com](http://www.clippard.com)



# Maximum Value. Maximum Performance.

For side ported manifold mount, the Maximatic line of valves offers both 1/4" actuator mount and 3/8" NAMUR mount

2-Way, 3-Way & 4-Way Designs

Choose either DIN connector with LED indicator or 18" Wire Lead connection. Both are rotatable and interchangeable.

Easily accessible locking or non-locking manual override switch

Port sizes from #10-32 to 1/2" NPT

Small size makes valves ideal for use in compact applications

Nitrile Seals

Sturdy aluminum body withstands rough environments

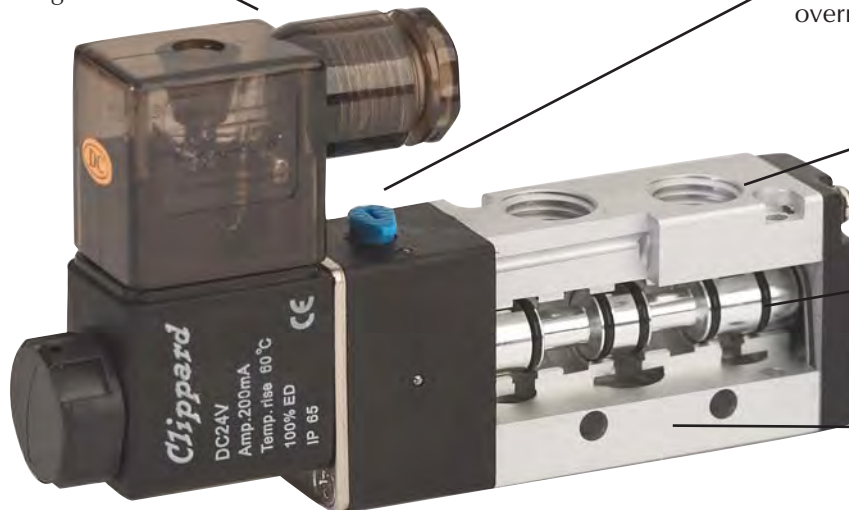

Operating ranges to 125 psig

Closed Center, Pressure Center and Exhaust Center Models Available

Maximatic® Valves are available as body ported, manifold mount, NAMUR (3/8" NPT only), and Actuator (1/4" NPT only) mounting. Standard models include a base that permits fast, secure mounting of electronic valves to a manifold for grouping in compact assemblies.

A wide variety of voltage options are available including 12 VDC, 24 VDC, 24 VAC, 110 VAC and 220 VAC. Consult factory for other voltages.

All Maximatic® Solenoid Valves are IP 65 CE Rating

# MAXIMATIC® SOLENOID VALVES

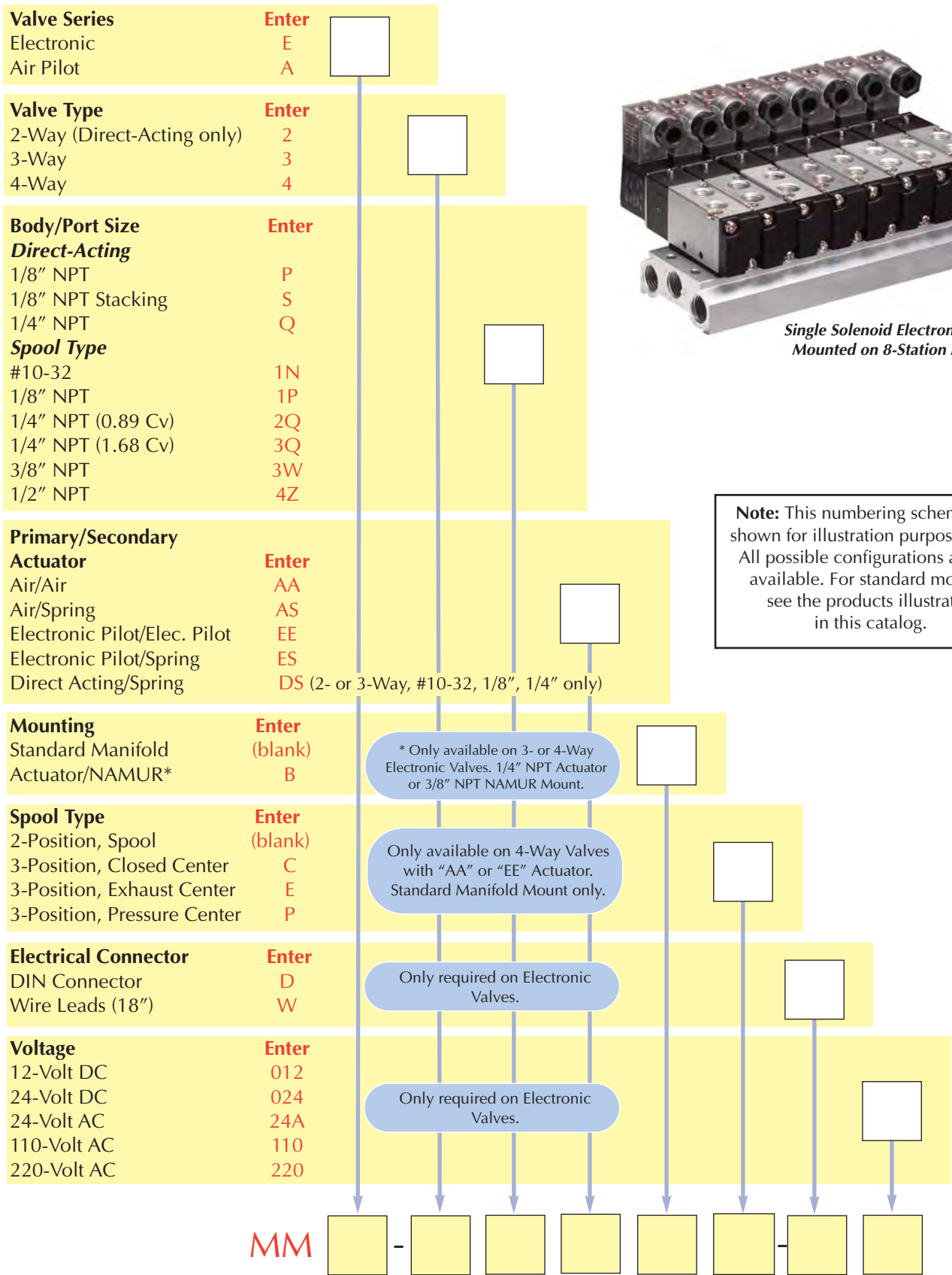

Single Solenoid Electronic Valves Mounted on 8-Station Manifold

**Note:** This numbering schematic is shown for illustration purposes only. All possible configurations are not available. For standard models, see the products illustrated in this catalog.

Metric line available. Visit [www.clippard.com](http://www.clippard.com)

Example: MM  E -  4  2Q  ES -  D  110



# MAXIMATIC® SOLENOID VALVES

## 2-Way Valves

| Series No. | Style  | Ports    |          |          | Function | Cv   | Flow @<br>100 psig |
|------------|--------|----------|----------|----------|----------|------|--------------------|
|            |        | Inlet    | Outlet   | Exhaust  |          |      |                    |
| MME-2PDS   | Poppet | 1/8" NPT | 1/8" NPT | 1/8" NPT | 2/2      | 0.12 | 6.7 scfm           |
| MME-2QDS   | Poppet | 1/4" NPT | 1/4" NPT | 1/4" NPT | 2/2      | 0.12 | 6.7 scfm           |
| MME-2SDS   | Poppet | 1/8" NPT | 1/8" NPT | 1/8" NPT | 2/2      | 0.05 | 2.3 scfm           |

## 3-Way Valves

|           |        |          |          |          |        |      |          |
|-----------|--------|----------|----------|----------|--------|------|----------|
| MME-3PDS  | Poppet | 1/8" NPT | 1/8" NPT | 1/8" NPT | 3/2    | 0.12 | 6.7 scfm |
| MME-3QDS  | Poppet | 1/4" NPT | 1/4" NPT | 1/4" NPT | 3/2    | 0.12 | 6.7 scfm |
| MME-3SDS  | Poppet | 1/8" NPT | 1/8" NPT | 1/8" NPT | 3/2    | 0.05 | 2.3 scfm |
| MME-31NES | Spool  | #10-32   | #10-32   | #10-32   | 3/2 NC | 0.58 | 27 scfm  |
| MME-31PES | Spool  | 1/8" NPT | 1/8" NPT | 1/8" NPT | 3/2 NC | 0.67 | 31 scfm  |
| MME-32QES | Spool  | 1/4" NPT | 1/4" NPT | 1/8" NPT | 3/2 NC | 0.89 | 49 scfm  |
| MME-33WES | Spool  | 3/8" NPT | 3/8" NPT | 1/4" NPT | 3/2 NC | 1.68 | 93 scfm  |
| MME-34ZES | Spool  | 1/2" NPT | 1/2" NPT | 1/2" NPT | 3/2 NC | 2.79 | 171 scfm |
| MME-31NEE | Spool  | #10-32   | #10-32   | #10-32   | 3/2    | 0.58 | 27 scfm  |
| MME-31PEE | Spool  | 1/8" NPT | 1/8" NPT | 1/8" NPT | 3/2    | 0.67 | 31 scfm  |
| MME-32QEE | Spool  | 1/4" NPT | 1/4" NPT | 1/8" NPT | 3/2    | 0.89 | 49 scfm  |
| MME-33WEE | Spool  | 3/8" NPT | 3/8" NPT | 1/4" NPT | 3/2    | 1.68 | 93 scfm  |
| MME-34ZEE | Spool  | 1/2" NPT | 1/2" NPT | 1/2" NPT | 3/2    | 2.79 | 171 scfm |

## 4-Way Valves

| Series No. | Style | Ports    |          |          | Function | Cv   | Flow @<br>100 psig | Spool Configuration |        |                |
|------------|-------|----------|----------|----------|----------|------|--------------------|---------------------|--------|----------------|
|            |       | Inlet    | Outlet   | Exhaust  |          |      |                    | Flow @<br>100 psig  | Center | Exhaust Center |
| MME-41NES  | Spool | #10-32   | #10-32   | #10-32   | 5/2      | 0.58 | 27 scfm            |                     |        |                |
| MME-41PES  | Spool | 1/8" NPT | 1/8" NPT | 1/8" NPT | 5/2      | 0.67 | 31 scfm            |                     |        |                |
| MME-42QES  | Spool | 1/4" NPT | 1/4" NPT | 1/8" NPT | 5/2      | 0.89 | 49 scfm            |                     |        |                |
| MME-43WES  | Spool | 3/8" NPT | 3/8" NPT | 1/4" NPT | 5/2      | 1.68 | 93 scfm            |                     |        |                |
| MME-44ZES  | Spool | 1/2" NPT | 1/2" NPT | 1/2" NPT | 5/2      | 2.79 | 171 scfm           |                     |        |                |
| MME-41NEE  | Spool | #10-32   | #10-32   | #10-32   | 5/2      | 0.58 | 27 scfm            |                     |        |                |
| MME-41PEE  | Spool | 1/8" NPT | 1/8" NPT | 1/8" NPT | 5/2      | 0.67 | 31 scfm            |                     |        |                |
| MME-42QEE  | Spool | 1/4" NPT | 1/4" NPT | 1/8" NPT | 5/2      | 0.89 | 49 scfm            |                     |        |                |
| MME-43WEE  | Spool | 3/8" NPT | 3/8" NPT | 1/4" NPT | 5/2      | 1.68 | 93 scfm            |                     |        |                |
| MME-44ZEE  | Spool | 1/2" NPT | 1/2" NPT | 1/2" NPT | 5/2      | 2.79 | 171 scfm           |                     |        |                |
| MME-41NEEC | Spool | #10-32   | #10-32   | #10-32   | 5/3      | 0.50 | 23 scfm            |                     | •      |                |
| MME-41PEEC | Spool | 1/8" NPT | 1/8" NPT | 1/8" NPT | 5/3      | 0.50 | 23 scfm            |                     | •      |                |
| MME-42QEEC | Spool | 1/4" NPT | 1/4" NPT | 1/8" NPT | 5/3      | 0.67 | 49 scfm            |                     | •      |                |
| MME-43WEEC | Spool | 3/8" NPT | 3/8" NPT | 1/4" NPT | 5/3      | 1.00 | 72 scfm            |                     | •      |                |
| MME-44ZEEC | Spool | 1/2" NPT | 1/2" NPT | 1/2" NPT | 5/3      | 1.68 | 93 scfm            |                     | •      |                |
| MME-41NEEP | Spool | #10-32   | #10-32   | #10-32   | 5/3      | 0.50 | 23 scfm            |                     |        | •              |
| MME-41PEEP | Spool | 1/8" NPT | 1/8" NPT | 1/8" NPT | 5/3      | 0.50 | 23 scfm            |                     |        | •              |
| MME-42QEEP | Spool | 1/4" NPT | 1/4" NPT | 1/8" NPT | 5/3      | 0.89 | 49 scfm            |                     |        | •              |
| MME-43WEEP | Spool | 3/8" NPT | 3/8" NPT | 1/4" NPT | 5/3      | 1.00 | 72 scfm            |                     |        | •              |
| MME-44ZEEP | Spool | 1/2" NPT | 1/2" NPT | 1/2" NPT | 5/3      | 1.68 | 93 scfm            |                     |        | •              |
| MME-41NEEE | Spool | #10-32   | #10-32   | #10-32   | 5/3      | 0.50 | 23 scfm            |                     | •      |                |
| MME-41PEEE | Spool | 1/8" NPT | 1/8" NPT | 1/8" NPT | 5/3      | 0.50 | 23 scfm            |                     | •      |                |
| MME-42QEEE | Spool | 1/4" NPT | 1/4" NPT | 1/8" NPT | 5/3      | 0.89 | 49 scfm            |                     | •      |                |
| MME-43WEEE | Spool | 3/8" NPT | 3/8" NPT | 1/4" NPT | 5/3      | 1.00 | 72 scfm            |                     | •      |                |
| MME-44ZEEE | Spool | 1/2" NPT | 1/2" NPT | 1/2" NPT | 5/3      | 1.68 | 93 scfm            |                     | •      |                |