



HIGH FLOW 2-WAY 10 MM MINIATURE VALVES

Specifications

Medium: Air, Gas or other Compatible Fluids

Working Pressure: 0 to 30 psig

Max. Flow Rate: 28 lpm

Orifice: 0.055"

Response Time: 8 ms when energized; 10 ms when de-energized

Electrical: 12 VDC or 24 VDC

Power Consumption: 3.5 watts in rush phase; 15 ms/0.35 watts in maintenance phase

Voltage Tolerance: -5% to +10%

Material: Stainless steel core and springs, nylon body, FKM dynamic seals, and Nitrile gasket and static seals.

Temperature Range: 23 to 122°F. When below 32°F, must use clean, dry air



90° Connector with LED

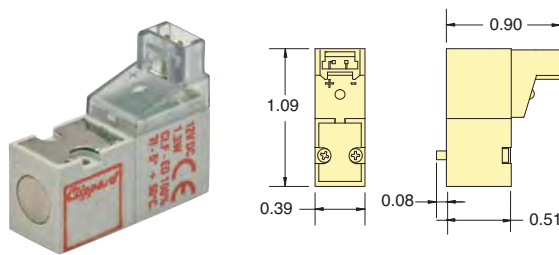

In-Line Connector with LED

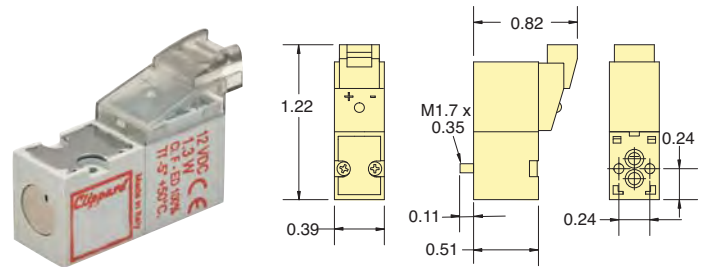

Part No.	Connector	Voltage
E210H-3L012	90° Connector	12 VDC
E210H-3L024	with LED	24 VDC
E210H-3C012	In-Line Connector	12 VDC
E210H-3C024	with LED	24 VDC

Typical Air Flow

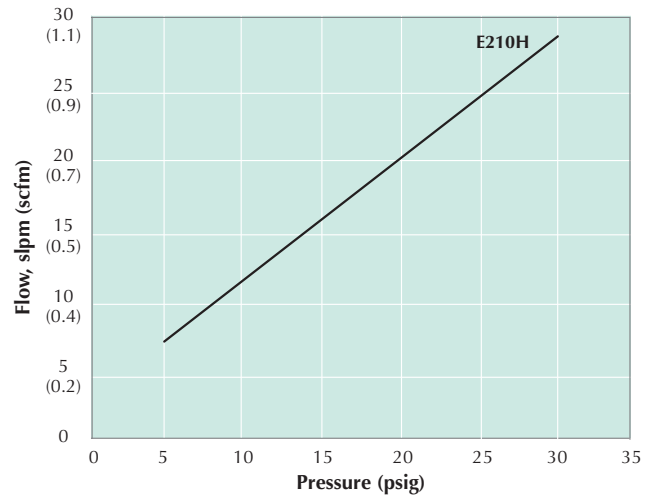

Mounting Interface

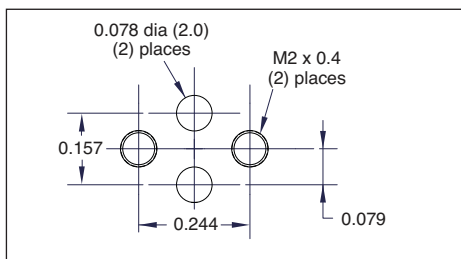

10 mm High Flow Single-Station Manifold

Spare hardware and closing plates available.

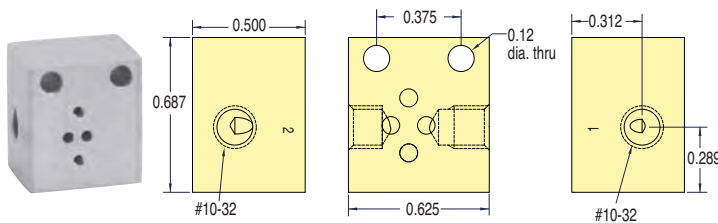

Part No.
E10HM-01 10 mm Single-Station Manifold

Functional Schematics

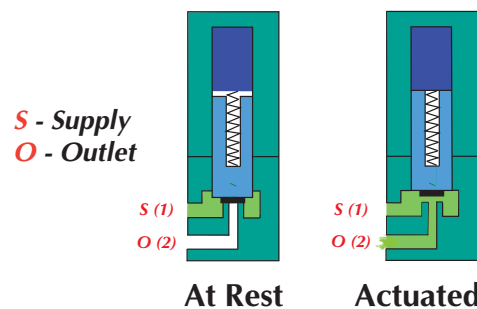

Specifications

Medium: Air, Gas, or other Compatible Fluids

Working Pressure: 0 to 102 psig

Maximum Flow Rate: 42 l/min

Exhaust Flow: 49 l/min

Orifice: 0.043"

Response Time: 8 ms when energized; 10 ms when de-energized

Material: Stainless steel core and springs, nylon body, FKM seals, and Nitrile gasket.

Voltage: 12-volt DC or 24-volt DC

Voltage Tolerance: -5% to +10%

Power Consumption: 3.5 watts in rush phase; 15 ms/0.35 watts in maintenance phase

Coil Insulation Class: F 311°F

Temperature Range: 23 to 122°F



90° Connector with LED

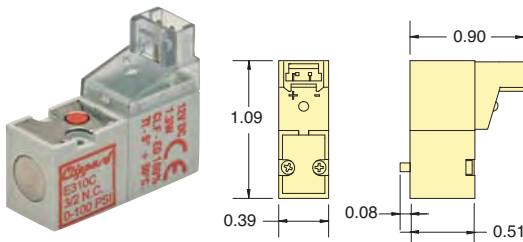

In-Line Connector with LED

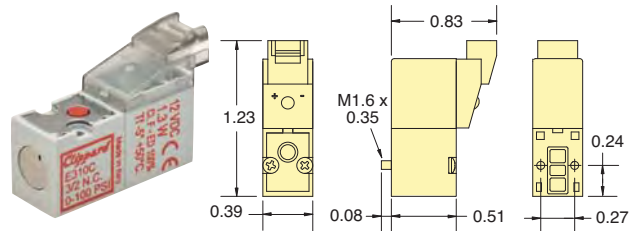

Part No.	Connector	Voltage
E311E-3L012	90° Connector	12 VDC
E311E-3L024	with LED	24 VDC
E311E-3C012	In-Line Connector	12 VDC
E311E-3C024	with LED	24 VDC

Mounting Interface

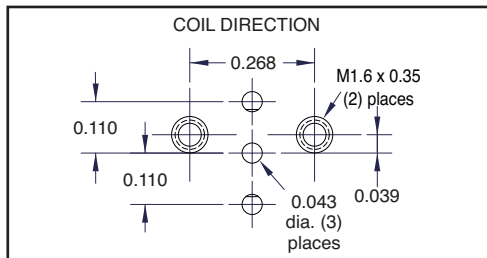

Typical Air Flow

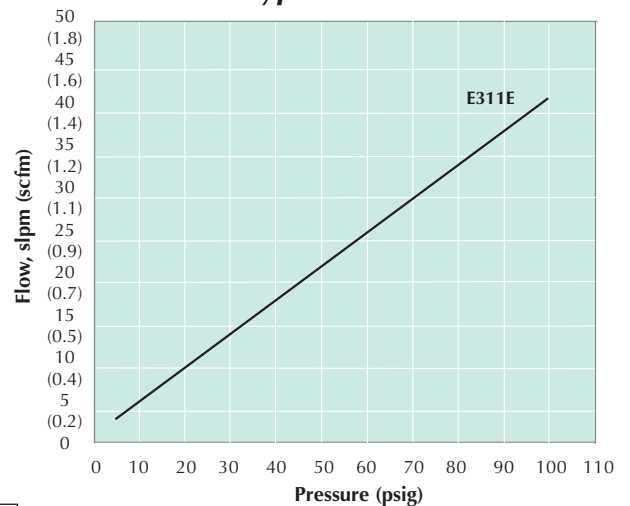

ISO 15218 10 mm High Flow Single-Station Manifold

Spare hardware and closing plates available.

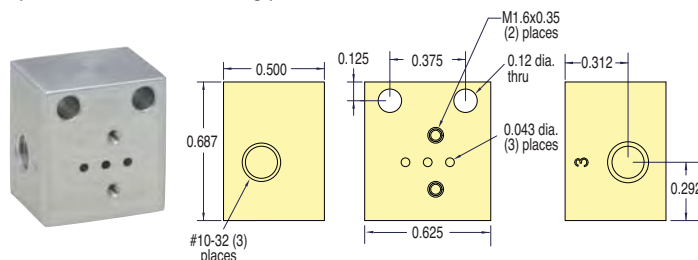

Part No.	Description
E10LM-01	ISO 10 mm Single-Station Manifold

Functional Schematics

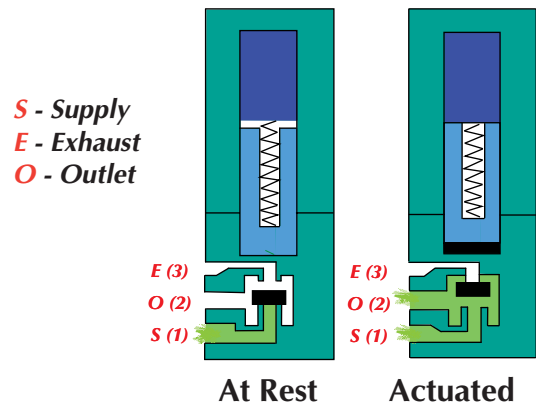



10 MM MINIATURE VALVE ACCESSORIES

Sub-Miniature Manifolds

Small, compact manifolds offer the efficient grouping of 10 mm valves along with fast installation. Easy manifold features a common inlet, individually-ported outlets, and exhaust to atmosphere.

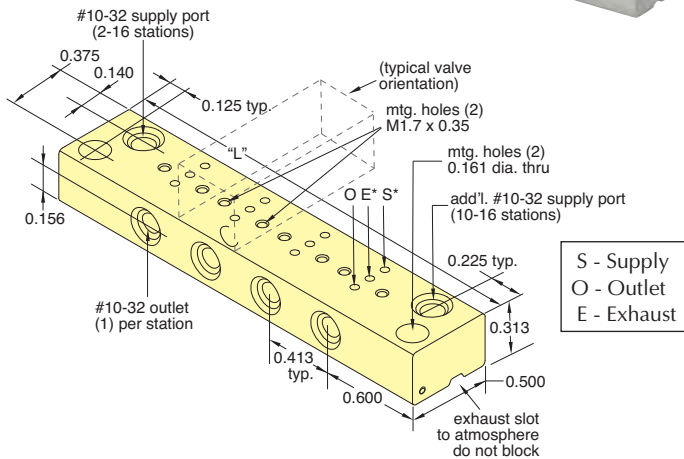

* For Normally-Open valves, supply to "E" and "S" becomes exhaust.

Stations	Supply Ports	Part No.	Length "L"
2	1	E10SM-02	1.61
4	1	E10SM-04	2.44
6	1	E10SM-06	3.27
8	1	E10SM-08	4.09
10	2	E10SM-10	4.92
12	2	E10SM-12	5.74
14	2	E10SM-14	6.57
16	2	E10SM-16	7.40

Cover Plate

Manifold Cover Plate includes plate, gasket and two screws.

Part No.
E10M-CP 10 mm Cover Plate

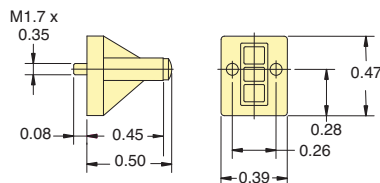

Standard Manifolds

Standard manifolds are available for one to 12 valves with ported exhaust. Spare hardware and closing plates available.

Part No.
E10M-01 Single-Station Manifold

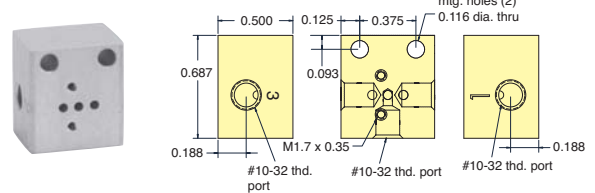

Multi-Station Manifolds

When using these manifolds with Normally-Closed valve configurations:

1. They cannot be used with Normally-Closed valves on the same manifold.
2. "E" becomes Supply, and "S" becomes Exhaust.

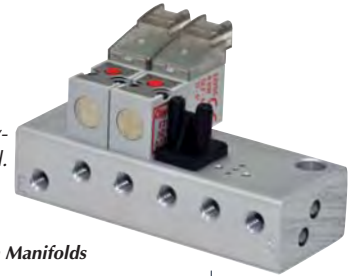

10- to 16-Station Manifolds

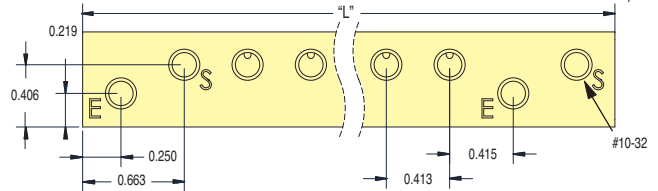
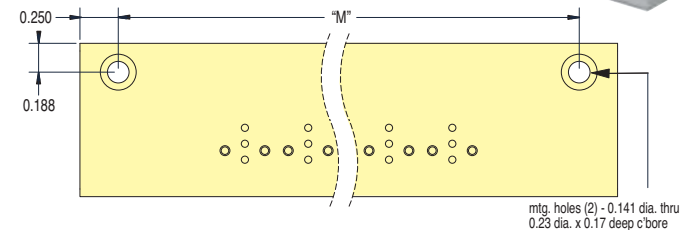

2- to 8-Station Manifolds

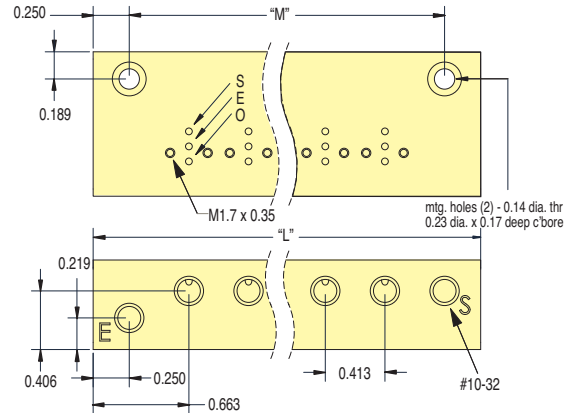

Part No.	Stations	Length "L"	Length "M"
E10M-02	2	1.74	1.24
E10M-04	4	2.57	2.07
E10M-06	6	3.39	2.89
E10M-08	8	4.22	3.72
E10M-10	10	5.87	5.37
E10M-12	12	6.70	6.20
E10M-14	14	7.52	7.02
E10M-16	16	8.35	7.85

15 MM MINIATURE VALVES



- Multiple Connectors
- Snap-in Plugs
 - Wire Leads
 - DIN Connector
 - Spade Terminals
 - Custom Plugs

LED for confirmation of operation available

Internal diodes for current spike suppression and a power saving circuit is available

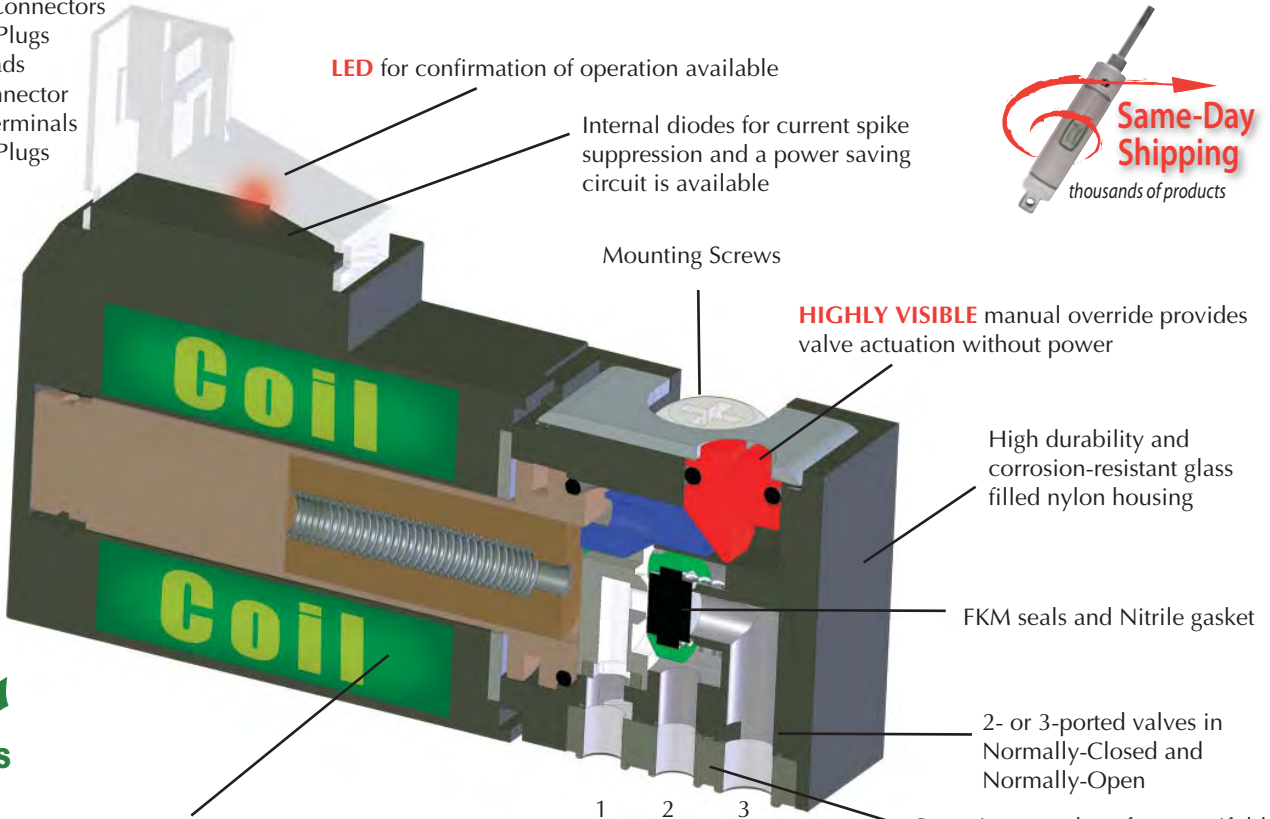

Mounting Screws

HIGHLY VISIBLE manual override provides valve actuation without power

High durability and corrosion-resistant glass filled nylon housing

FKM seals and Nitrile gasket

2- or 3-ported valves in Normally-Closed and Normally-Open

One-piece gasket for manifold mount and supply/exhaust port reversed for same manifold mounting of N.O. or N.C. valve



Encapsulated low wattage coils. Available in: 12 VDC, 24 VDC, 24 VAC, 110 VAC or 220 VAC. Special voltages available for OEMs.

Configuration	1	2	3
N.C. & N.O.	exhaust	outlet	supply

Functional Schematics

Normally-Closed 3-Way Valve

S - Supply
E - Exhaust
O - Outlet

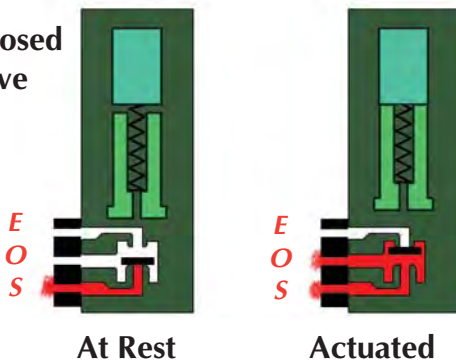

Normally-Open 3-Way Valve

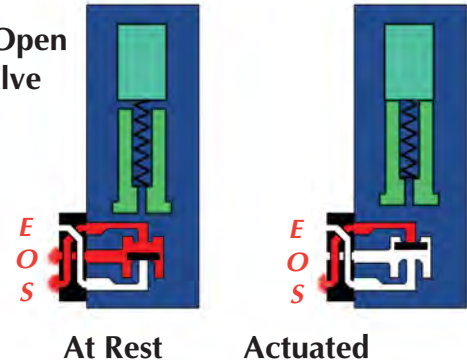

Porting Gasket
The Normally-Open and Normally-Closed configurations allow both models to be mounted on the same manifold.

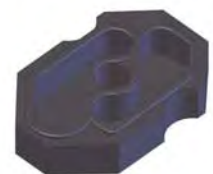



15 MM MINIATURE VALVES

Specifications

Medium: Air, Gas, or other Compatible Fluids

Working Pressure: See Chart below.

Maximum Flow Rate:
 0.032" Orifice: 45 l/min
 0.043" Orifice: 70 l/min
 0.063" Orifice: 91 l/min

Response Time: 10 ms when energized; 12 ms when de-energized



Material: Stainless steel core and springs, springs, nylon body, FKM seals, and Nitrile gasket.

Voltage: 12-volt DC, 24-volt DC or 24-volt AC. 110-volt AC and 220-volt AC only available with DIN Connectors.

Voltage Tolerance: -5% to +10%

Power Consumption: 1.0 or 2.5 watts dependent on orifice size and pressure

Coil Insulation Class: F 311°F

Temperature Range: 23 to 122°F



Order Information

Type	Base No.	Connector	12	24	24	110	220	Orifice	Wattage	Working Pressure
			VDC	VDC	VAC	VAC	VAC			
2/2 Normally-Closed 	E215D-1T*	Terminal	•	•				0.032"	1.0	0 to 150 psig
	E215E-2T*		•	•	•			0.043"	2.5	0 to 150 psig
	E215F-2T*		•	•	•			0.063"	2.5	0 to 110 psig
	E215D-1D*	DIN Connector	•	•				0.032"	1.0	0 to 150 psig
	E215E-2D*		•	•	•	•	•	0.043"	2.5	0 to 150 psig
	E215F-2D*		•	•	•	•	•	0.063"	2.5	0 to 110 psig
	E215D-1W*	Wire Leads, 11.8"	•	•				0.032"	1.0	0 to 150 psig
	E215E-2W*		•	•	•			0.043"	2.5	0 to 150 psig
	E215F-2W*		•	•	•			0.063"	2.5	0 to 110 psig
	E215D-1L*	90° Connector with LED	•	•				0.032"	1.0	0 to 150 psig
	E215E-2L*		•	•				0.043"	2.5	0 to 150 psig
	E215F-2L*		•	•				0.063"	2.5	0 to 110 psig
E215D-1C*	In-Line Connector with LED	•	•				0.032"	1.0	0 to 150 psig	
E215E-2C*		•	•				0.043"	2.5	0 to 150 psig	
E215F-2C*		•	•				0.063"	2.5	0 to 110 psig	
3/2 Normally-Closed 	E315D-1T*	Terminal	•	•				0.032"	1.0	0 to 150 psig
	E315E-2T*		•	•	•			0.043"	2.5	0 to 150 psig
	E315F-2T*		•	•	•			0.063"	2.5	0 to 110 psig
	E315D-1D*	DIN Connector	•	•				0.032"	1.0	0 to 150 psig
	E315E-2D*		•	•	•	•	•	0.043"	2.5	0 to 150 psig
	E315F-2D*		•	•	•	•	•	0.063"	2.5	0 to 110 psig
	E315D-1W*	Wire Leads, 11.8"	•	•				0.032"	1.0	0 to 150 psig
	E315E-2W*		•	•	•			0.043"	2.5	0 to 150 psig
	E315F-2W*		•	•	•			0.063"	2.5	0 to 110 psig
	E315D-1L*	90° Connector with LED	•	•				0.032"	1.0	0 to 150 psig
	E315E-2L*		•	•				0.043"	2.5	0 to 150 psig
	E315F-2L*		•	•				0.063"	2.5	0 to 110 psig
E315D-1C*	In-Line Connector with LED	•	•				0.032"	1.0	0 to 150 psig	
E315E-2C*		•	•				0.063"	2.5	0 to 150 psig	
E315F-2C*		•	•				0.063"	2.5	0 to 110 psig	
3/2 Normally-Open (110 psig max.) 	E3O15E-2T*	Terminal	•	•	•			0.043"	2.5	0 to 110 psig
	E3O15F-2T*		•	•	•			0.063"	2.5	0 to 75 psig
	E3O15E-2D*	DIN Connector	•	•	•	•	•	0.043"	2.5	0 to 110 psig
	E3O15F-2D*		•	•	•	•	•	0.063"	2.5	0 to 75 psig
	E3O15E-2W*	Wire Leads, 11.8"	•	•	•			0.043"	2.5	0 to 110 psig
	E3O15F-2W*		•	•	•			0.063"	2.5	0 to 75 psig
	E3O15E-2L*	90° Connector with LED	•	•				0.043"	2.5	0 to 110 psig
	E3O15F-2L*		•	•				0.063"	2.5	0 to 75 psig
E3O15E-2C*	In-Line Connector with LED	•	•				0.063"	2.5	0 to 110 psig	
E3O15F-2C*		•	•				0.063"	2.5	0 to 75 psig	

• Indicates standard items

* Add Voltage Choice to the end of each Base Part Number. "012" (12 VDC), "024" (24 VDC) "24A" (24 VAC), "110" (110 VAC) or "220" (220 VAC). Example: **E315D-1C012**

15 MM MINIATURE VALVES



Terminal Connector



Industrial Form C Connector ordered separately below.

DIN Connector



DIN Connector ordered separately below.

In-Line Connector with LED



Wire Leads

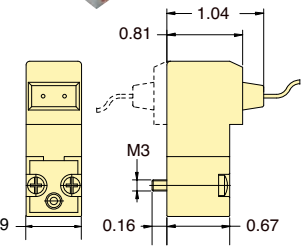
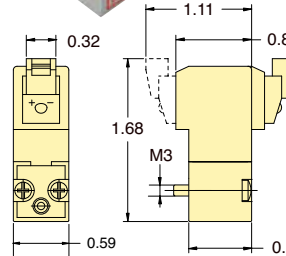
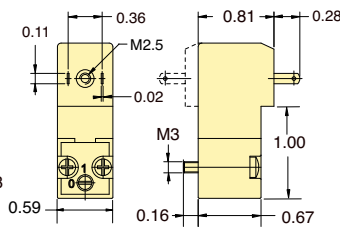
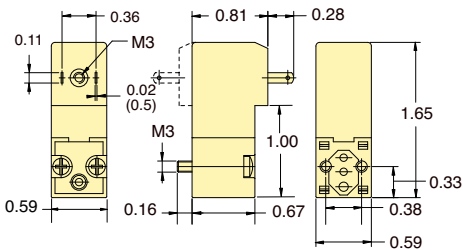

90° Connector with LED

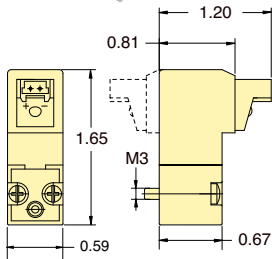

Typical Air Flow

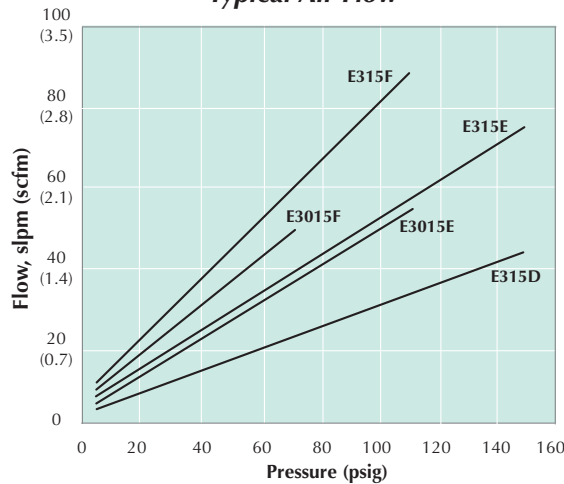

Mounting Interface

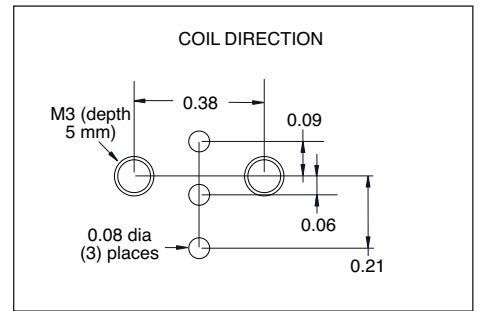

DIN Connectors

For Use with 15 mm Valves Only

DIN 43650 Form C Connectors with 8 mm spade center spacing mate with the 15 mm DIN connector coil. Industrial Form Connectors with 9.4 mm spade center spacing are designed to connect to 15 mm terminal coils. Both are available with or without surge suppression, and 152 or 381 mm PVC molded three-wire cord set.

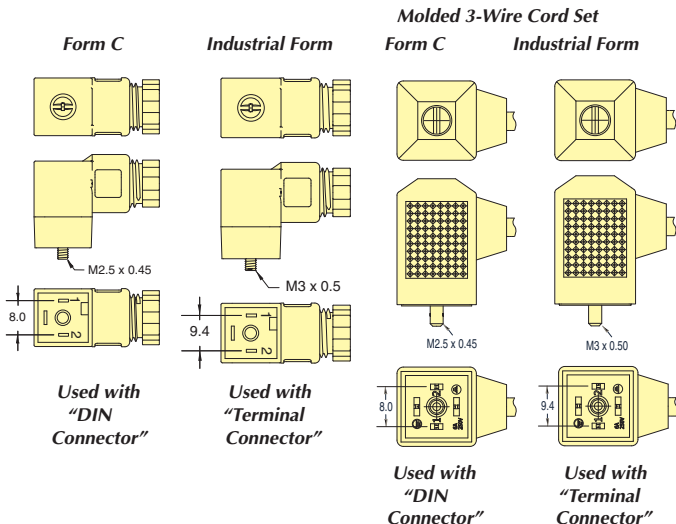

Form C Part No.	Industrial Form Part No.	Volts	LED	Cord
CC-C	CC-I	6-240	no	-
CC-C-P6	CC-I-P6	6-240	no	6'
CC-C-P15	CC-I-P15	6-240	no	15'
CC-CLL	CC-ILL	6-24	yes	-
CC-CLL-P6	CC-ILL-P6	6-24	yes	6'
CC-CLL-P15	CC-ILL-P15	6-24	yes	15'
CC-CLM	CC-ILM	48-110	yes	-
CC-CLM-P6	CC-ILM-P6	48-110	yes	6'
CC-CLM-P15	CC-ILM-P15	48-110	yes	15'



LATCHING 15 MM MINIATURE VALVES



- 2-Way & 3-Way Normally-Closed configurations
- Pulse-actuated (on or off)
- 3-wire coil. No polarity reverse required
- Stable latch

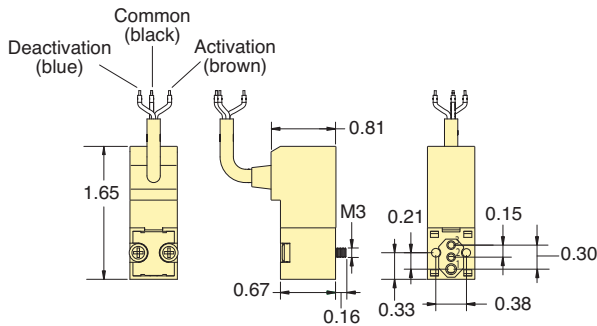

Clippard's 15 mm Latching Valves have many of the same features as the popular 15 mm standard valve line including small, compact design, exceptional life and reliability, light-weight design and more. A careful balance of forces—through the precise placement of a permanent magnet in the valve core—produces a bi-stable valve. A short pulse of current opens the valve, which “latches” open indefinitely after the current stops. A subsequent pulse of current in the opposite direction closes the valve. The valve consumes less energy and produces less heat than a standard solenoid valve when used in extended duty cycle applications, since the coil is energized for only a small fraction of the total duty cycle.

Medium: Air, Gas or other Compatible Fluids

Max. Flow Rate: 0.043" Orifice: 59 l/min
0.063" Orifice: 84 l/min

Electrical Connection: 3-Wire Molded Cord, 300 mm, 24 AWG 4.5 mm external jacket; tinned copper wires; silicone jacket and conductor insulation)

Electrical: 12 VDC (“-012”) or 24 VDC (“-024”). 6 VDC also available. Call for further information.

Electrical Tolerance: -5 to +10%



Response Time: 10 ms when energized; 12 ms when de-energized

Copper Wire Isolation Class: F 311°F

Material: Stainless steel core and springs, nylon body, FKM dynamic seals, and Nitrile gasket and static seals.

Temperature Range: 23 to 122°F. When below 32°F, must use clean, dry air

Mounting Interface

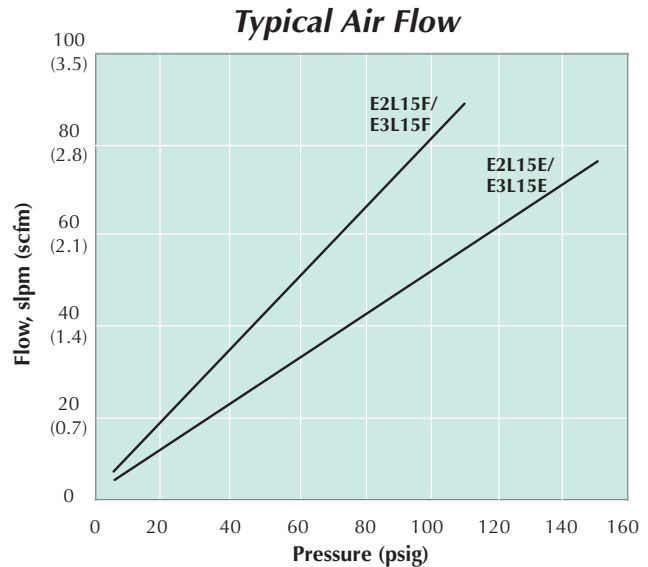
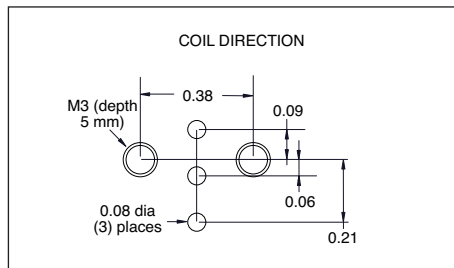

Type	Part No.	Connector	Orifice	Voltage	Wattage	Pressure Range
2-Way	E2L15E-4W012	3-Wire Molded Cord, 300 mm	0.043"	12 VDC	4.0	0 to 150 psig
	E2L15E-4W024		0.043"	24 VDC		0 to 150 psig
	E2L15F-4W012		0.063"	12 VDC		0 to 110 psig
	E2L15F-4W024		0.063"	24 VDC		0 to 110 psig
3-Way	E3L15E-4W012	3-Wire Molded Cord, 300 mm	0.043"	12 VDC	4.0	0 to 150 psig
	E3L15E-4W024		0.043"	24 VDC		0 to 150 psig
	E3L15F-4W012		0.063"	12 VDC		0 to 110 psig
	E3L15F-4W024		0.063"	24 VDC		0 to 110 psig

See page 214 for connectors and manifolds

HIGH FLOW 2-WAY N.C. 15 MM VALVES



Specifications

Medium: Air, Gas, or other Compatible Fluids

Working Pressure: 0 to 43 psig

Maximum Flow Rate: 120 l/min

Orifice: 0.118"

Material: Stainless steel core and springs, nylon body, FKM seals, and Nitrile gasket.

Response Time: 10 ms when energized; 12 ms when de-energized

Voltage: 12-volt DC or 24-volt DC

Voltage Tolerance: -5% to +10%

Power Consumption: 4.0 watts

Coil Insulation Class: F 311°F

Temperature Range: 23 to 122°F



90° Connector with LED

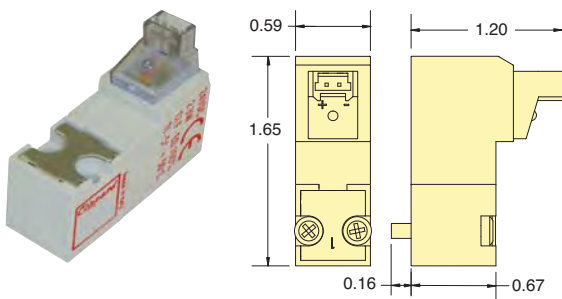

In-Line Connector with LED

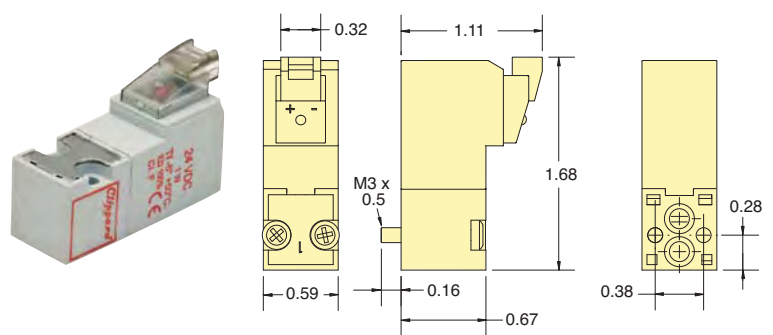

Part No.	Connector	Voltage
E215H-3L012	90° Connector	12 VDC
E215H-3L024	with LED	24 VDC
E215H-3C012	In-Line Connector	12 VDC
E215H-3C024	with LED	24 VDC

Mounting Interface

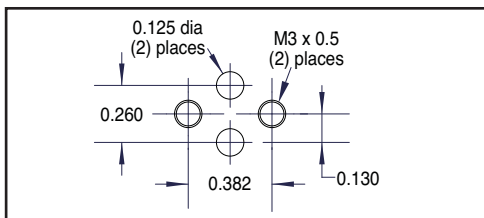

Typical Air Flow

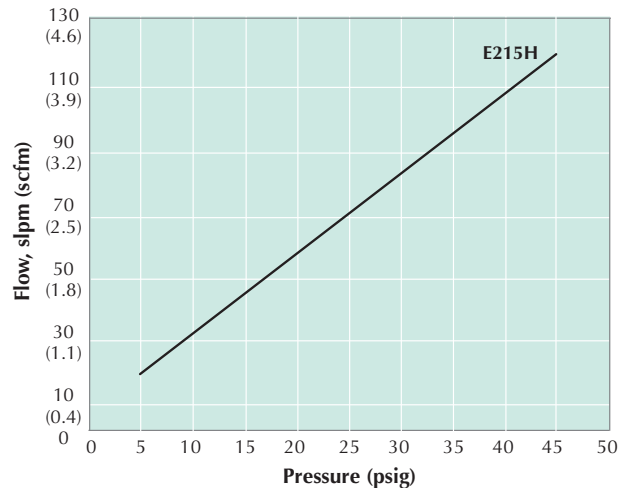

15 mm High Flow Single-Station Manifold

Spare hardware and closing plates available.

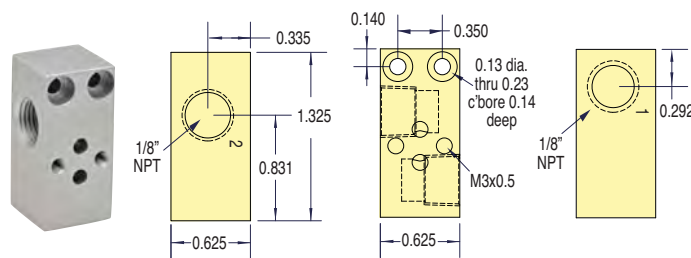

Part No.
E15HM-01 15 mm Single-Station Manifold

Metric line available. Visit www.clippard.com

Functional Schematics

