



MOUSE VALVE SERIES DESCRIPTIONS



Standard Series

2- and 3-way manifold and in-line mounting. Normally-Closed and fully-ported versions.

Higher Flow 2-Way Version. The standard series also includes an option that provides higher flow for 2-way, Normally-Closed applications. Although manifold mounting is accomplished in the same fashion, the inlet is the annular port, and the outlet becomes the center port, through the convenient stud mount of the valve.

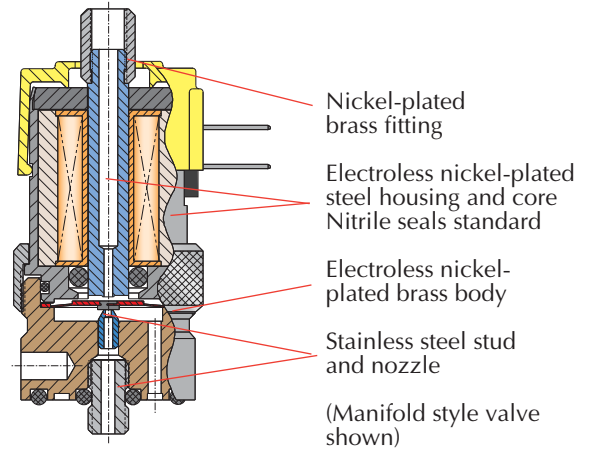

Corrosion-Resistant "CR-" Series

Clippard's Corrosion-Resistant Series (CR-) incorporates materials and construction that provides enhanced protection for valves used with mildly corrosive media such as moisture in air or gases. Where stainless steel is not possible, plating is incorporated to add life to wear components. A nickel-plated brass valve body is standard, but stainless steel may be substituted.

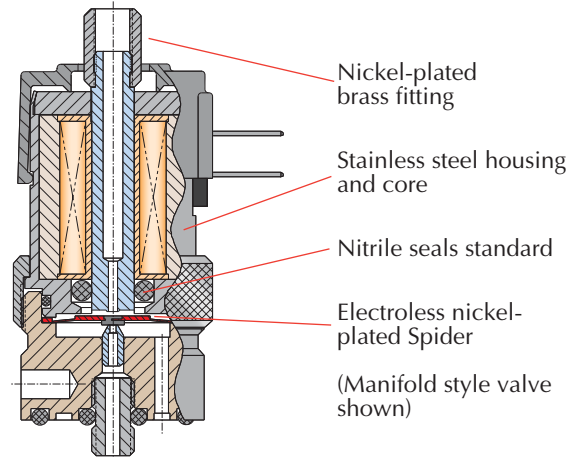

Analytical "A-" Series

Clippard's Electronic Analytical Valve (A-) series combines the proven features of the "Mouse" series with the specific needs of the analytical industry, and for applications where cleanliness is especially important. Special materials, manufacturing and assembly processes make this valve perfectly suited for applications where internal cleanliness, bubble-tight operation, and long life are imperative.

For more information, visit clippard.com/analytical

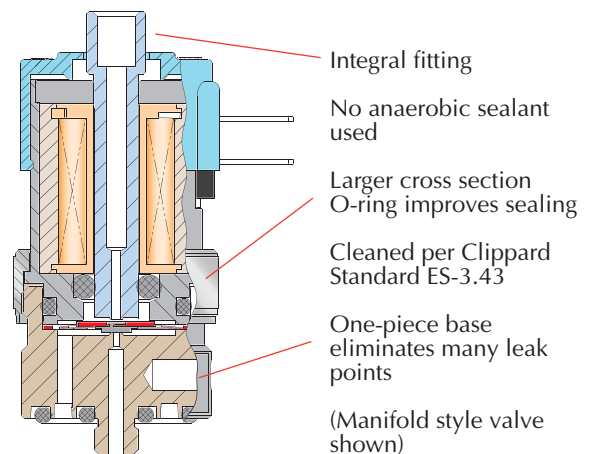



Oxygen Clean "O-" Series

All EV, ET, EC and EW series electronic valves with the "O-" part number option are available manufactured and assembled for use in Oxygen-enriched environments for applications that are extremely sensitive to contamination.

- Valves are ultrasonically cleaned, assembled, inspected and tested in an enclosed controlled area with a state-of-the-art positive pressure HEPA filtration system
- Both organic and inorganic contaminants such as particulate matter and Hydrocarbon oils are removed
- No organic sealants, adhesives or lubricants are used in the manufacturing process
- Component parts are lubricated with Oxygen-compatible PFPE (perfluoropolyether) grease, only as needed for assembly
- Individual testing and inspection is accomplished utilizing compressed Nitrogen and ultra-violet light

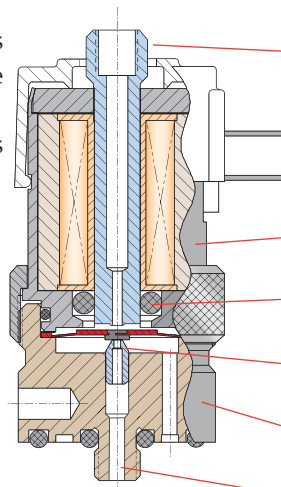

- Integral fitting
No thread sealant
- All wetted parts cleaned per Clippard Standard ES-3.41
- Electroless nickel-plated steel housing and core
- FKM seals
- Stainless steel nozzle
- Electroless nickel-plated brass body
- Integral stud
No thread sealant
- PFPE lubricant
(Manifold style valve shown)

For more information on the process, visit www.clippard.com/oxygen



ECN, EVN, ETN Mouse Valves

Normally-Open, manifold mount to allow Normally-Closed and Normally-Open valves on the same manifold. See page 187 for ordering information.

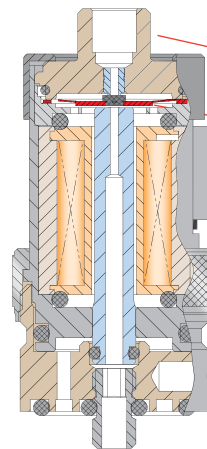

- Integral fitting
- Armature "spider" above coil
- Mounts side-by-side with Normally-Closed version
- (Manifold style valve shown)

Custom EV Valves

Don't see it here? Call us! Many people shy away from asking for customized products and fear increased price and lead times. Clippard's electronic valve production consist of nearly 50% customized product. From the simple tweaks to complex challenges, Clippard is your partner for finding the right solution to your needs.



Metric line available. Visit www.clippard.com



MOUNTING OPTIONS & FLOW DIAGRAMS

Electrical Connection Options

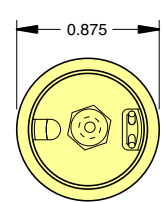
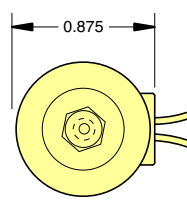
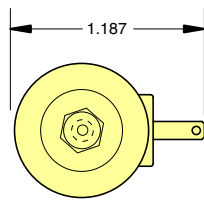
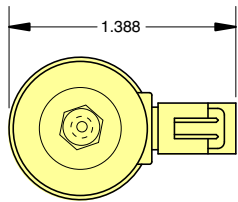

In-Line Mount

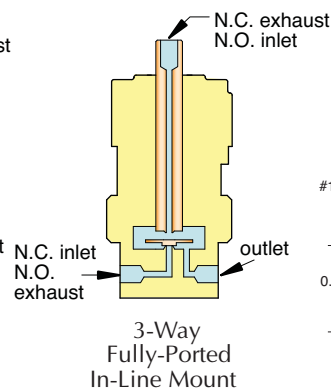
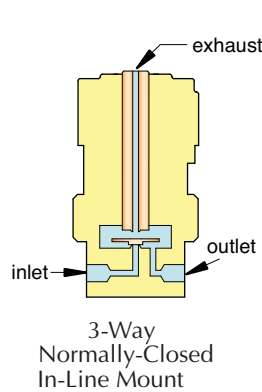
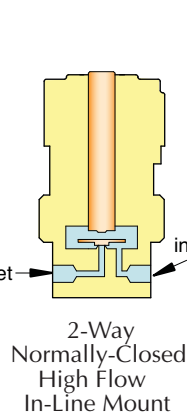
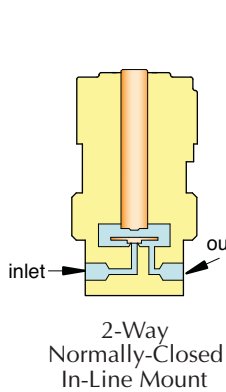

Mounting Options

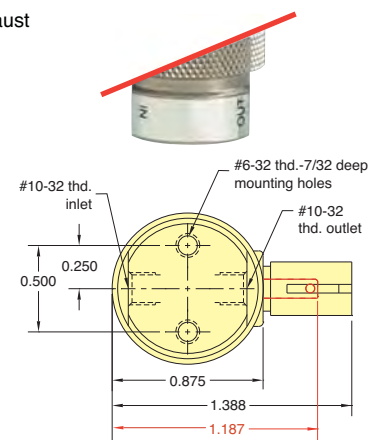

Manifold Mount

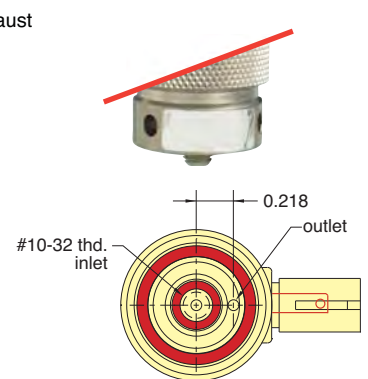
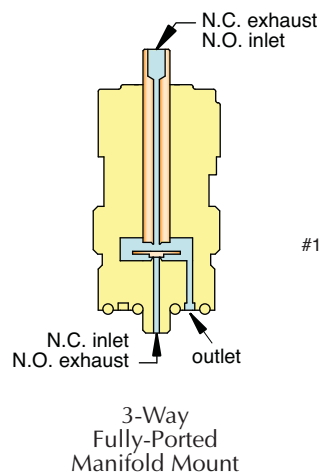
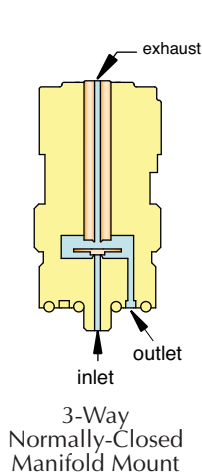
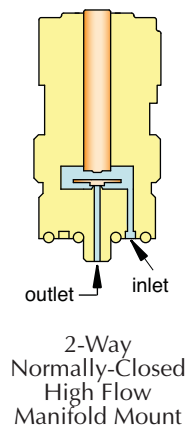
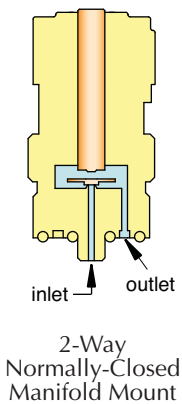



Typical Air Flow

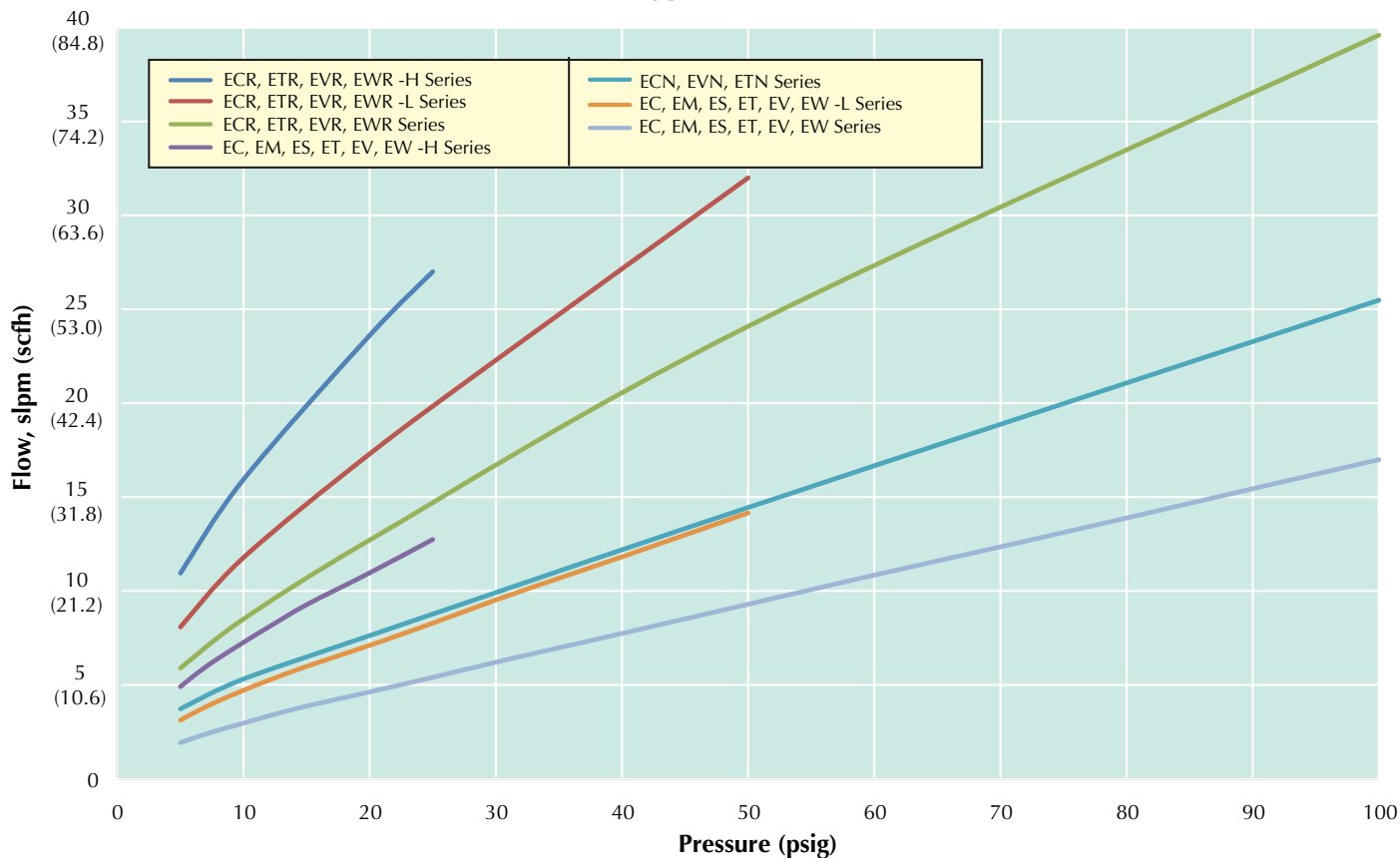

Electrical Specifications

Series	Nominal			Power (watts)	Working Range (cont. duty)
	Voltage	Current (amps)	Resistance (ohms)		
- Standard - Oxygen Clean - Analytical	12	0.055	218	0.67	90 to 150% of rated voltage
	24	0.028	864		
- Corrosion-Resistant	12	0.098	122	1.2	90 to 110% of rated voltage
	24	0.049	486		
- EM Series - ES Series	12	0.083	144	1.0	90 to 120% of rated voltage
	24	0.042	576		

Metric line available. Visit www.clippard.com



2-WAY NORMALLY-CLOSED VALVES, IN-LINE & MANIFOLD MOUNT

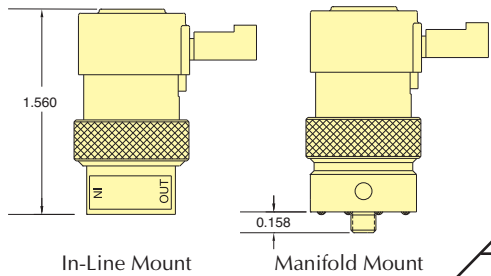

		Vac. to 105 psig		Vac. to 50 psig		Vac. to 25 psig		12 VDC		24 VDC		Part No.		
		Pressure Range		Voltage		In-Line Mount		Manifold Mount						
		•			•		*EC-2-12	*EC-2M-12	•					
		•			•			*EC-2-24	*EC-2M-24	•				
			•			•		*EC-2-12-L	*EC-2M-12-L		•			
			•				•	*EC-2-24-L	*EC-2M-24-L			•		
				•			•	*EC-2-12-H	*EC-2M-12-H				•	
			•			•	*EC-2-24-H	*EC-2M-24-H					•	
		•			•		*ET-2-12	*ET-2M-12	•					
		•			•			*ET-2-24	*ET-2M-24	•				
			•			•		*ET-2-12-L	*ET-2M-12-L		•			
			•				•	*ET-2-24-L	*ET-2M-24-L			•		
				•			•	*ET-2-12-H	*ET-2M-12-H				•	
			•			•	*ET-2-24-H	*ET-2M-24-H					•	
		•			•		*EV-2-12	*EV-2M-12	•					
		•			•			*EV-2-24	*EV-2M-24	•				
			•			•		*EV-2-12-L	*EV-2M-12-L		•			
			•				•	*EV-2-24-L	*EV-2M-24-L			•		
				•			•	*EV-2-12-H	*EV-2M-12-H				•	
			•			•	*EV-2-24-H	*EV-2M-24-H					•	
		•			•		*EW-2-12	*EW-2M-12	•					
		•			•			*EW-2-24	*EW-2M-24	•				
			•			•		*EW-2-12-L	*EW-2M-12-L		•			
			•				•	*EW-2-24-L	*EW-2M-24-L			•		
				•			•	*EW-2-12-H	*EW-2M-12-H				•	
			•			•	*EW-2-24-H	*EW-2M-24-H					•	

- Medium:** Clean, dry air (40 micron filter)
- Power Consumption:** 0.67 watt (CR Series: 1.2 watt)
- Temperature Range:** 32 to 180°F; CR Series: 32 to 150°F
- Response:** 5 to 10 milliseconds (nominal)
- Operating Range:** 90 to 150% of rated voltage (CR Series: ±10%)
- Ports:** #10-32



Valve Series (*)	Standard	Non-Standard
Standard	(blank)	
Oxygen Clean	O-	See Pages 179 & 180 for further information
Analytical Series**	A-	
Corrosion-Resistant (not std. on "EW")	CR-	
Options (add to end of Part No.)		
FKM Seals	-V	
EPR Seals		-E
Silicone Seals		-S
Diode		-D

Example Part No's:
ET-2M-12-V
CR-ET-2-12

See Page 181 for mounting options

** Available on manifold mount valves only

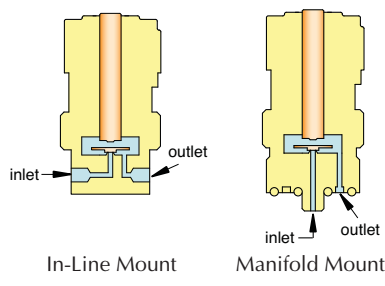

Pressure Range	Suffix	Air Flow
28" Hg Vac. to 105 psig	(blank)	0.6 scfm @ 100 psig
28" Hg Vac. to 50 psig	-L	0.5 scfm @ 50 psig
28" Hg Vac. to 25 psig	-H	0.45 scfm @ 25 psig

2-WAY NORMALLY-CLOSED HIGH FLOW VALVES, IN-LINE & MANIFOLD MOUNT

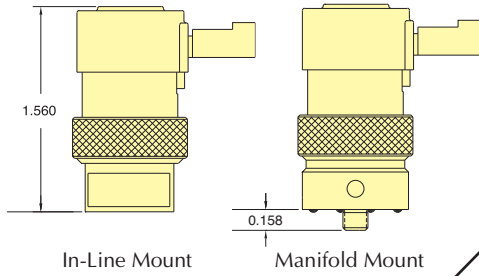

Part No.

		Pressure Range			Voltage		In-Line Mount	Manifold Mount
		Vac. to 105 psig	Vac. to 50 psig	Vac. to 25 psig	12 VDC	24 VDC		
 0.025" Pin Connector		•			•		*ECR-2-12	*ECR-2M-12
		•			•		*ECR-2-24	*ECR-2M-24
 0.025" Pin Connector			•		•		*ECR-2-12-L	*ECR-2M-12-L
			•		•		*ECR-2-24-L	*ECR-2M-24-L
 Spade Terminals		•			•		*ETR-2-12	*ETR-2M-12
		•			•		*ETR-2-24	*ETR-2M-24
 Spade Terminals			•		•		*ETR-2-12-L	*ETR-2M-12-L
			•		•		*ETR-2-24-L	*ETR-2M-24-L
 Wire Leads Side (Radial)		•		•	•		*EVR-2-12	*EVR-2M-12
		•		•	•		*EVR-2-24	*EVR-2M-24
 Wire Leads Side (Radial)			•		•		*EVR-2-12-L	*EVR-2M-12-L
			•		•		*EVR-2-24-L	*EVR-2M-24-L
 Wire Leads Top (Axial)		•			•		*EVR-2-12-H	*EVR-2M-12-H
		•			•		*EVR-2-24-H	*EVR-2M-24-H
 Wire Leads Top (Axial)			•		•		*EWR-2-12	*EWR-2M-12
			•		•		*EWR-2-24	*EWR-2M-24
 Wire Leads Top (Axial)			•		•		*EWR-2-12-L	*EWR-2M-12-L
			•		•		*EWR-2-24-L	*EWR-2M-24-L
 Wire Leads Top (Axial)		•			•		*EWR-2-12-H	*EWR-2M-12-H
		•			•		*EWR-2-24-H	*EWR-2M-24-H

Medium: Clean, dry air (40 micron filter)

Power Consumption: 1.2 watt

Temperature Range: 32 to 150°F

Response: 10 milliseconds (nominal)

Operating Range: ±10% of rated voltage

Ports: #10-32



Valve Series (*)	Standard	Non-Standard
Standard Analytical Series**	(blank) A-	See Pages 179 & 180 for further information
Options (add to end of Part No.)		
FKM Seals	-V	
EPR Seals		-E
Silicone Seals		-S
Diode		-D

See Page 181 for mounting options

** Available on manifold mount valves only

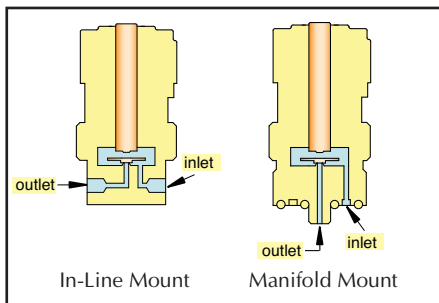

Pressure Range	Suffix	Air Flow
28" Hg Vac. to 100 psig	(blank)	1.4 scfm @ 100 psig
28" Hg Vac. to 50 psig	-L	1.1 scfm @ 50 psig
28" Hg Vac. to 25 psig	-H	0.95 scfm @ 25 psig

Metric line available. Visit www.clippard.com



3-WAY NORMALLY-CLOSED VALVES, IN-LINE & MANIFOLD

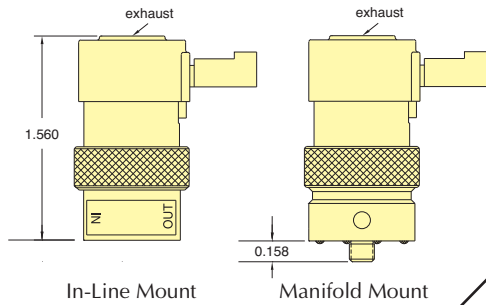

		Pressure Range		Voltage		Part No.		
		Vac. to 105 psig		Vac. to 50 psig		In-Line Mount	Manifold Mount	
		Vac. to 25 psig		12 VDC	24 VDC			
 0.025" Pin Connector		•		•	•	*EC-3-12	*EC-3M-12	
		•		•	•	*EC-3-24	*EC-3M-24	
			•		•	•	*EC-3-12-L	*EC-3M-12-L
			•		•	•	*EC-3-24-L	*EC-3M-24-L
				•		•	•	*EC-3-12-H
			•		•	*EC-3-24-H	*EC-3M-24-H	
 Spade Terminals		•		•	•	*ET-3-12	*ET-3M-12	
		•		•	•	*ET-3-24	*ET-3M-24	
			•		•	•	*ET-3-12-L	*ET-3M-12-L
			•		•	•	*ET-3-24-L	*ET-3M-24-L
				•		•	•	*ET-3-12-H
			•		•	*ET-3-24-H	*ET-3M-24-H	
 Wire Leads Side (Radial)		•		•	•	*EV-3-12	*EV-3M-12	
		•		•	•	*EV-3-24	*EV-3M-24	
			•		•	•	*EV-3-12-L	*EV-3M-12-L
			•		•	•	*EV-3-24-L	*EV-3M-24-L
				•		•	•	*EV-3-12-H
			•		•	*EV-3-24-H	*EV-3M-24-H	
 Wire Leads Top (Axial)		•		•	•	*EW-3-12	*EW-3M-12	
		•		•	•	*EW-3-24	*EW-3M-24	
			•		•	•	*EW-3-12-L	*EW-3M-12-L
			•		•	•	*EW-3-24-L	*EW-3M-24-L
				•		•	•	*EW-3-12-H
			•		•	*EW-3-24-H	*EW-3M-24-H	

- Medium:** Clean, dry air (40 micron filter)
- Power Consumption:** 0.67 watt (CR Series: 1.2 watt)
- Temperature Range:** 32 to 180°F, CR Series: 32 to 150°F
- Response:** 5 to 10 milliseconds (nominal)
- Operating Range:** 90 to 150% of rated voltage (CR Series: ±10%)
- Ports:** #10-32



Valve Series (*)	Standard	Non-Standard
Standard	(blank)	
Oxygen Clean Analytical Series**	O- A- CR-	See Pages 179 & 180 for further information
Corrosion-Resistant (not std. on "EW")		
Options (add to end of Part No.)		
FKM Seals	-V	
EPR Seals		-E
Silicone Seals		-S
Diode		-D

Example Part No's:
ET-3-12-S
O-EW-3-24

See Page 181 for mounting options

** Available on manifold mount valves only

Pressure Range	Suffix	Air Flow
28" Hg Vac. to 105 psig	(blank)	0.6 scfm @ 100 psig
28" Hg Vac. to 50 psig	-L	0.5 scfm @ 50 psig
28" Hg Vac. to 25 psig	-H	0.45 scfm @ 25 psig

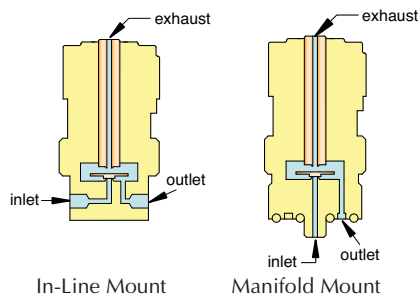

3-WAY FULLY-PORTED VALVES, IN-LINE & MANIFOLD

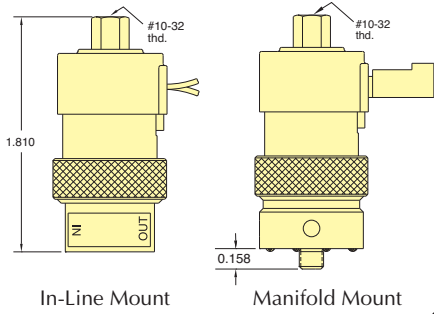

Part No.

		Pressure Range		Voltage		In-Line Mount	Manifold Mount
		Vac. to 105 psig	Vac. to 50 psig	Vac. to 25 psig	12 VDC	24 VDC	
 0.025" Pin Connector	•				•	*ECO-3-12	*ECO-3M-12
	•				•	*ECO-3-24	*ECO-3M-24
		•			•	*ECO-3-12-L	*ECO-3M-12-L
		•			•	*ECO-3-24-L	*ECO-3M-24-L
			•		•	*ECO-3-12-H	*ECO-3M-12-H
			•	•		*ECO-3-24-H	*ECO-3M-24-H
 Spade Terminals	•				•	*ETO-3-12	*ETO-3M-12
	•				•	*ETO-3-24	*ETO-3M-24
		•			•	*ETO-3-12-L	*ETO-3M-12-L
		•			•	*ETO-3-24-L	*ETO-3M-24-L
			•		•	*ETO-3-12-H	*ETO-3M-12-H
			•	•		*ETO-3-24-H	*ETO-3M-24-H
 Wire Leads Side (Radial)	•				•	*EVO-3-12	*EVO-3M-12
	•				•	*EVO-3-24	*EVO-3M-24
		•			•	*EVO-3-12-L	*EVO-3M-12-L
		•			•	*EVO-3-24-L	*EVO-3M-24-L
			•		•	*EVO-3-12-H	*EVO-3M-12-H
			•	•		*EVO-3-24-H	*EVO-3M-24-H
 Wire Leads Top (Axial)	•				•	*EWO-3-12	*EWO-3M-12
	•				•	*EWO-3-24	*EWO-3M-24
		•			•	*EWO-3-12-L	*EWO-3M-12-L
		•			•	*EWO-3-24-L	*EWO-3M-24-L
			•		•	*EWO-3-12-H	*EWO-3M-12-H
			•	•		*EWO-3-24-H	*EWO-3M-24-H

Medium: Clean, dry air (40 micron filter)

Power Consumption: 0.67 watt (CR Series: 1.2 watt)

Temperature Range: 32 to 180°F, CR Series: 32 to 150°F

Response: 5 to 10 milliseconds (nominal)

Operating Range: 90 to 150% of rated voltage (CR Series: ±10%)

Ports: #10-32



Valve Series (*)	Standard	Non-Standard
Standard	(blank)	
Oxygen Clean	O-	See Pages 179 & 180 for further information
Analytical Series**	A-	
Corrosion-Resistant	CR-	
<i>(not std. on "EWO")</i>		
Options (add to end of Part No.)		
FKM Seals	-V	
EPR Seals		-E
Silicone Seals		-S
Diode		-D

Example Part No's:
ETO-3M-24-D
CR-EVO-3-12

See Page 181 for mounting options

** Available on manifold mount valves only

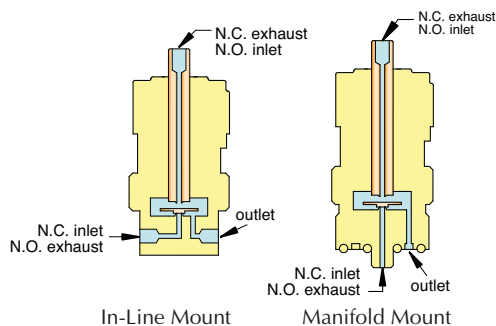

Pressure Range	Suffix	Air Flow
28" Hg Vac. to 105 psig	(blank)	0.6 scfm @ 100 psig
28" Hg Vac. to 50 psig	-L	0.5 scfm @ 50 psig
28" Hg Vac. to 25 psig	-H	0.45 scfm @ 25 psig

Metric line available. Visit www.clippard.com



2-WAY & 3-WAY NORMALLY-OPEN VALVES, MANIFOLD

		Voltage		Part No.	
		12 VDC	24 VDC	2-Way	3-Way
 0.025" Pin Connector	•		ECN-2M-12	ECN-3M-12	
		•	ECN-2M-24	ECN-3M-24	
 Spade Terminals	•		ETN-2M-12	ETN-3M-12	
		•	ETN-2M-24	ETN-3M-24	
 Wire Leads Side (Radial)	•		EVN-2M-12	EVN-3M-12	
		•	EVN-2M-24	EVN-3M-24	

- Medium:** Clean, dry air (40 micron filter)
- Power Consumption:** 0.67 watt
- Temperature Range:** 32 to 180°F
- Response:** 5 to 10 milliseconds (nominal)
- Operating Range:** 90 to 150% of rated voltage
- Voltage:** 12 VDC or 24 VDC. Other voltages available upon request.
- Ports:** #10-32



Valve Series (*)	Standard	Non-Standard
Standard	(blank)	
Options (add to end of Part No.)		
FKM Seals	-V	
EPR Seals		-E
Silicone Seals		-S
Diode		-D

Example Part No's:
EVN-2M-12-V
ETN-3M-24

See Page 181 for mounting options

Pressure Range	Air Flow
28" Hg Vac. to 105 psig	0.9 scfm @ 100 psig

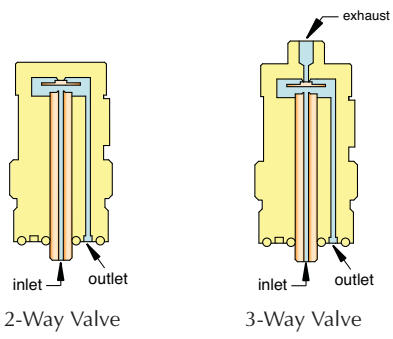

2- & 3-WAY INTRINSICALLY SAFE VALVES



2-WAY INTRINSICALLY SAFE NORMALLY-CLOSED VALVES, IN-LINE & MANIFOLD MOUNT

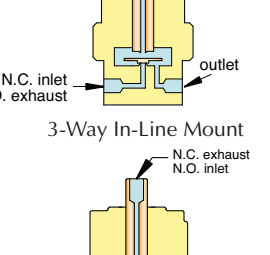
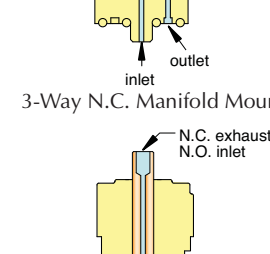
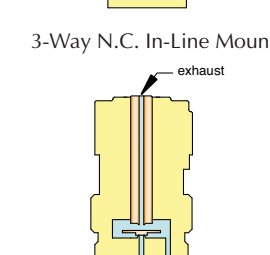
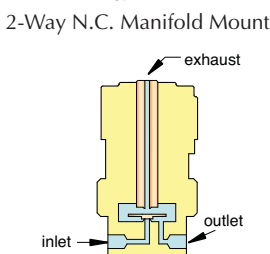
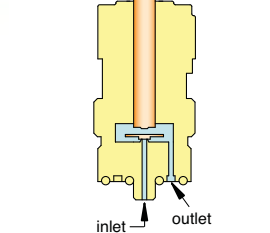
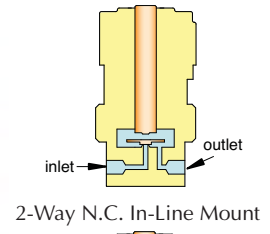
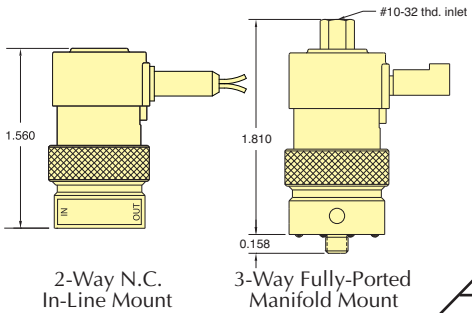

Pressure Range	Part No.	
	In-Line Mount	Manifold Mount
• Vac. to 105 psig • Vac. to 50 psig • Vac. to 25 psig	•	EI-2-15.5
	•	EI-2-15.5-L
	•	EI-2-15.5-H
•	•	EI-2-15.5-C
	•	EI-2-15.5-LC
	•	EI-2-15.5-HC

3-WAY INTRINSICALLY SAFE NORMALLY-CLOSED VALVES, IN-LINE & MANIFOLD MOUNT

•	•	EI-3-15.5
	•	EI-3-15.5-L
	•	EI-3-15.5-H
•	•	EI-3-15.5-C
	•	EI-3-15.5-LC
	•	EI-3-15.5-HC

3-WAY INTRINSICALLY SAFE FULLY-PORTED VALVES, IN-LINE & MANIFOLD MOUNT

•	•	EIO-3-15.5
	•	EIO-3-15.5-L
	•	EIO-3-15.5-H
•	•	EIO-3-15.5-C
	•	EIO-3-15.5-LC
	•	EIO-3-15.5-HC

Medium: Clean, dry air (40 micron filter)

Power Consumption: 0.67 watt

Temperature Range: 32 to 180°F

Response: 5 to 10 milliseconds (nominal)

Operating Range: 90 to 150% of rated voltage

Voltage: 15.5 VDC

Ports: #10-32 and manifold mount



Pressure Range	Suffix	Air Flow
28" Hg Vac. to 105 psig	(blank)	0.6 scfm @ 100 psig
28" Hg Vac. to 50 psig	-L	0.5 scfm @ 50 psig
28" Hg Vac. to 25 psig	-H	0.45 scfm @ 25 psig

See Page 181 for mounting options

Other seal materials optional

See www.clippard.com for more information



EV, ET, EC, EW SERIES HIGHER FLOW VALVES

EC, EV, ET & EW PILOTED 2-WAY & 3-WAY NORMALLY-CLOSED, PRESSURE PILOTED VALVES, MANIFOLD MOUNT

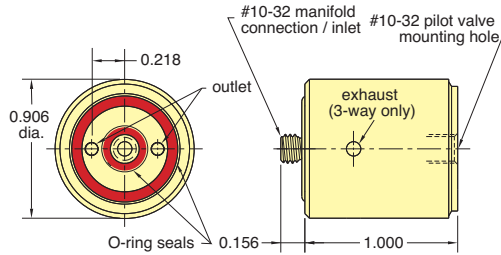

Medium: Air

Materials: Nickel-plated brass, acetal, stainless steel and Nitrile

Response: 20 milliseconds @ 20 psig;
13 milliseconds @ 100 psig nominal

Ports: Inlet and outlet through manifold

Material: Nickel-plated brass, acetal, stainless steel and Nitrile

Note: Use only Normally-Closed 3-Way Pilot valves in conjunction with EVB-2/EVB-3

Part No.

- EVB-2 2-Way Valve Booster
- EVB-3 3-Way Valve Booster

Input Pressure	Air Flow
20 to 150 psig	6.1 scfm @ 100 psig

ELECTRONIC INTERFACE 3-WAY NORMALLY-CLOSED VALVE

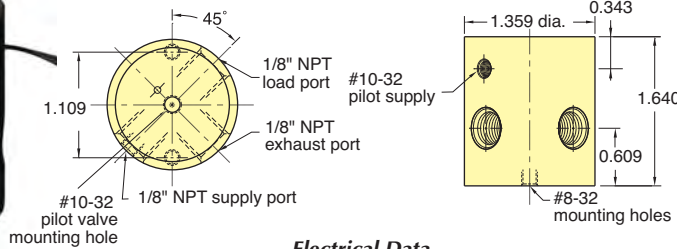

Medium: Air

Filtration: 10 micron

Ports: 1/8" NPT female

Switching Speed: 10 milliseconds

Bleed Flow: 0.10 scfm @ 100 psig

Frequency Response: 50 Hz @ 100 psig;
70 Hz @ 30 psig

Part No.

- 2013-6 Interface Valve, 6 VDC
- 2013-12 Interface Valve, 12 VDC
- 2013-24 Interface Valve, 24 VDC

Continuous Overload: 350% @ 25°C ambient; 250% @ 50°C ambient

Power Consumption: Less than 0.50 watts @ rated voltage (80 ma. @ 6 VDC, 40 ma. @ 12 VDC 20 ma. @ 24VDC)

Leads: 28 gauge stranded PVC insulated

Input Pressure	Air Flow
30 to 100 psig <i>call for special configurations</i>	22 scfm @ 100 psig

3-WAY NORMALLY-CLOSED, PRESSURE PILOTED VALVES

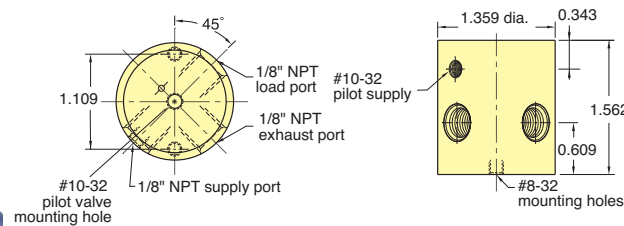

Medium: Air

Pilot Pressure: (2020) 60% of supply pressure, minimum

Response: Approximately 20 milliseconds

Mounting: Mounting holes provided

Ports: Inlet and outlet, exhaust 1/8" NPT Pilot supply on 2020 is #10-32 female

Materials: Anodized Aluminum, Stainless Steel and Nitrile

Additional Note: Use only Normally-Closed 3-way pilot valves in conjunction with 2020/2021

Designed to be piloted by a Clippard EC, EV and ET manifold mount electronic valve (not included). Output from the EC, EV and ET actuates the valve to produce outputs up to 22 scfm at 100 psig. Combines low wattage, long life and cool running of the EC, EV and ET valves with quick response and high flow of Clippard "Fluidamp" type valves. The 2020 and 2021 are identical in all respects except one. The 2020 has an external #10-32 pilot port.

Part No.

- 2020 External Piloted Valve with #10-32 Port
- 2021 Internal Piloted Valve

Input Pressure	Air Flow
30 to 100 psig <i>call for special configurations</i>	22 scfm @ 100 psig

ET PILOTED 4-WAY VALVES & CONNECTORS



4-WAY PILOTED VALVES

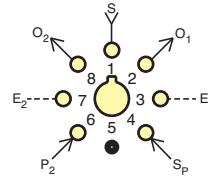
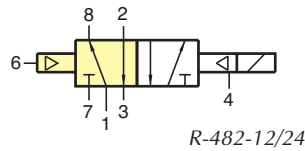
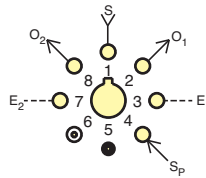
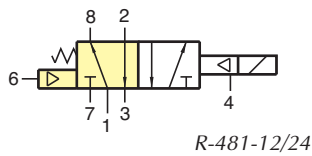

Type: 4-way combination electronic and modular spool type interface valve. Fully-ported ET-3 & R-401 (R-481)/R-402 (R-482) hybrid

Medium: Air, water, or oil; pilot - air only

Mounting: Uses Octoport base and two captivated screws

Ports: Valve has patented Octoport system

Note: Supply pressure must be applied to both ports 1 and 4. Minimum pressure on port 4 should be 40 psig.

Part No.

R-481-12	ET-3/R-401, 12 VDC
R-481-24	ET-3/R-401, 24 VDC
R-482-12	ET-3/R-402, 12 VDC
R-482-24	ET-3/R-402, 24 VDC

Input Pressure	Air Flow
Pilot: 40 psig min.	9 scfm @ 100 psig
Working: 0 to 150 psig	

For more information please see Page 270 in the Modular Valve section of this catalog.

ET VALVE CONNECTORS

Black molded lug connectors are available for easy push-on connection ET-C48 is 48" in length, ET-C120 is 120" in length.



Insulated crimp-on spade lug connectors are available for wiring up leads to connect an electronic circuit to ET style valves. Accepts #22, #24, or #26 wire.



Part No.

ET-C48	48" Connector
ET-C120	120" Connector

Part No.

3831	Spade Lug Connector
------	---------------------

EC & EI VALVE CONNECTORS

TE Connectivity #5-103956-1 with 18" or 120" wire leads for EC/ECO and EI/EIO valves.

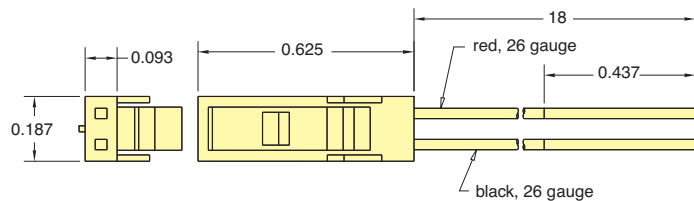

Part No.

C2-RB18	18" Connector
C2-RB120	120" Connector



CUSTOM PORTS & CONNECTORS

If you need a product that fits your application perfectly, Clippard has the capability to design or modify one of its products to suit your exact needs.

This application requires a special connection to a MAPP gas canister. The valve is tested for response time and flow rate, which delivers a consistent amount of gas each cycle.

CUSTOMer solutions

Metric line available. Visit www.clippard.com



EV, ET, EC, EW SERIES ACCESSORIES

Specialized Manifolds

Material: ENP brass Option: Oxygen Clean version (add O-)

15490-1

#10-32 Inlet
1/8" NPT Outlet

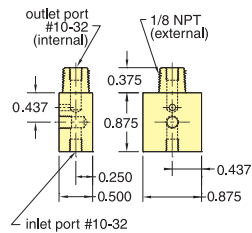

15490-2

1/8" NPT Inlet
#10-32 Outlet

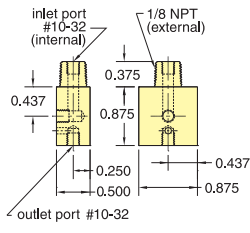

15490-3 Dual Outlet

1/8" NPT Inlet
#10-32 Outlet

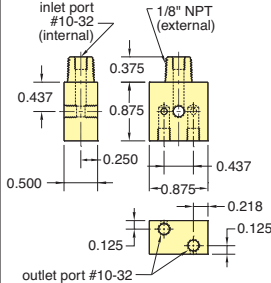

15491-1

#10-32 Inlet
1/8" NPT Outlet

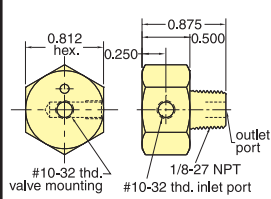

15491-2

1/8" NPT (R1/8) Inlet
#10-32 Outlet

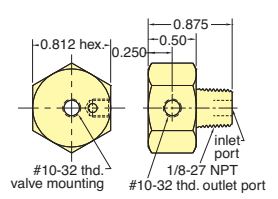

Use: Mount EV, ET, EC, and EW valves to any 1/8" NPT supply port

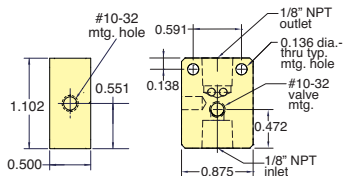

15490-5

1/8" NPT Inlet
1/8" NPT Outlet

Oxygen Clean Manifolds

Multi-station manifolds are available for use with Clippard's Oxygen Clean series electronic valves. These manifolds offer either single-sided or double-side mounting in Oxygen-compatible ENP brass material.

The Oxygen series products are manufactured and assembled for applications in Oxygen-enriched environments which are extremely sensitive to contamination. Each manifold is cleaned according to Clippard Specification #ES-3.41, and double bagged in heat-sealed polyethylene bags.



Input Ports: In-line 1/8" NPT

Outlet Ports: #10-32

Mounting: #10-32 tapped holes

Materials: ENP Brass

Single-Sided		Double-Sided		Length "A"	Mtg. "L"	"M"
Part No.	Stations	Part No.	Stations			
O-15581-2*	2			0.444	1.826	0.937
O-15581-4*	4	O-15582-8*	8	0.913	3.702	1.875
O-15581-6*	6	O-15582-12*	12	0.913	5.577	3.750

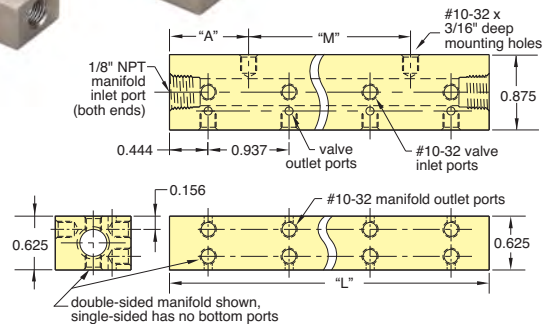

Multi-Valve Manifolds

Construction: Black anodized aluminum



Single-Sided		Double-Sided		Length "A"	Mtg. "L"	"M"
Part No.	Stations	Part No.	Stations			
15481-2	2			0.444	1.826	0.937
15481-4	4	15482-8	8	0.913	3.702	1.875
15481-6	6	15482-12	12	0.913	5.577	3.750

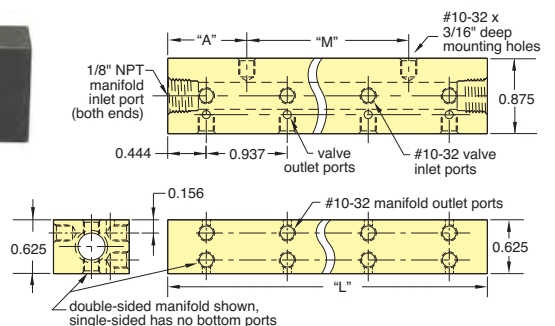



Auxiliary Power Input

Power to operate the valves may be provided through two sources: ONE, through the 25-pin connector if your signal source also has sufficient power to operate the bank of valves, or TWO, through a separate auxiliary power input connection built into the board. To isolate power from the 25-pin connector, use the power source selector switch.

NOTE: In applying power on a temporary basis, use care to observe proper circuit polarity.

Reverse Polarity Protection

Circuit using diodes and capacitor provides input voltage protection against reverse polarity.

Resistor-Diode-LED Circuit

Individual circuit to each valve provides protection against shut-off spikes. LED is illuminated when valve is actuated.

Printed Circuit Board

Durable laminated fiberglass

3-Position Detented Switches

Three position slide switch provides for: ON - Power "ON"; valve is activated; OFF - Power "OFF"; valve not connected; CONN - Valve connected to 25-pin connector, and will be controlled through it.

Power Selector Switch

Two-position selector switch enables choice of power input source (25-pin connector or auxiliary).

25-Pin Connector

Clippard Electronic Valves

Clippard Valve Manifold

Compact, efficient mounting of the valves is by Clippard multi-valve manifolds.

LED Bank

Illuminated LED signals that the valve is actuated.

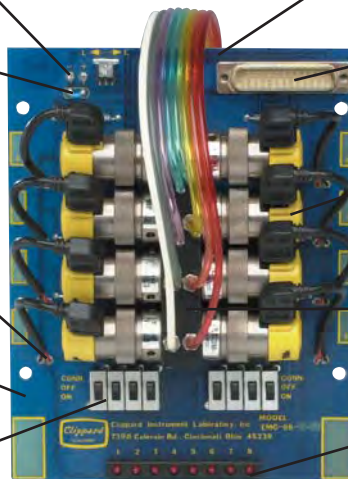

Clippard Electronic Manifold Cards

Now you can direct low-voltage DC signals from controllers, systems, computers or other sources to operate powerful pneumatic valves with a minimum of piping and hook-up.

Self-contained card includes:

- 8 or 12 Clippard ET interface valves
- Manifold mount for single air supply
- Circuit board fully wired
- Instant plug-in with 25-pin connector
- Resistor, diode, LED and switch for each valve
- Auxiliary power supply connection

Ready to operate quickly. Just mount the card and make external connection. And each valve may be individually removed and replaced without any need for desoldering!

Convenience in interfacing electronics and pneumatics . . . completely assembled, manifolded valve cards.

Features

- Fast, easy to mount
- Pre-assembled; all valves mounted
- Low power requirements (0.67 watt per valve)
- Choice of valve types
- Each valve switchable
- Shut-off spike protection
- 25-pin connector
- No expensive card rack required

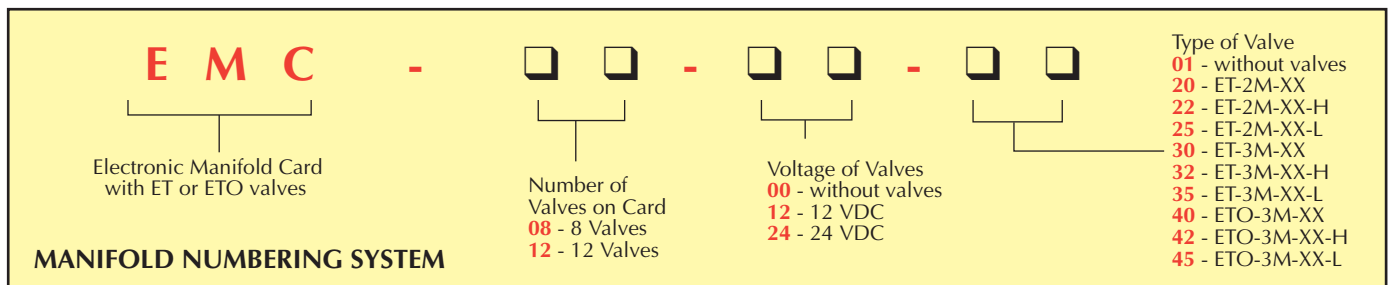

EMC-08-00-01 and EMC-12-00-01 are part numbers for cards without any valves, and without manifold. Manifold mounting hardware is included. Manifolds may be ordered separately, if desired. Part numbers are: 15482-8 and 15482-12.



ELECTRONIC MANIFOLD CARD

EMC-08

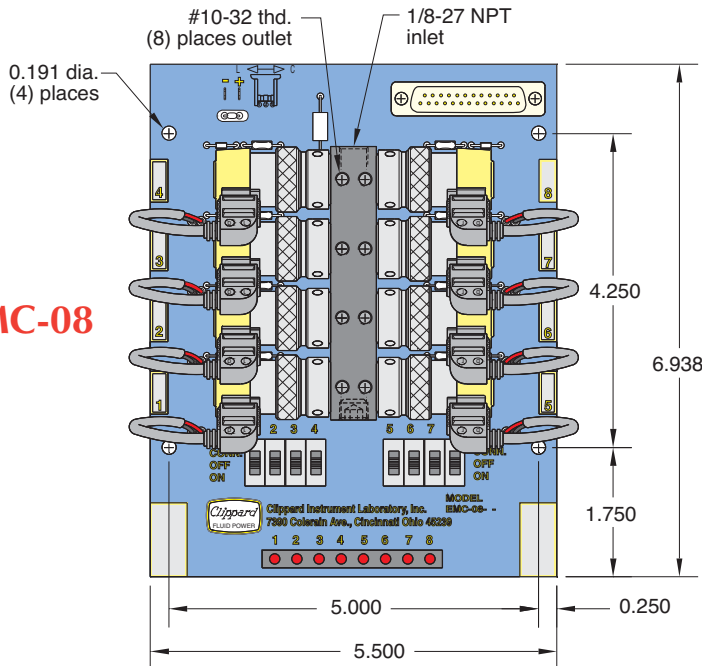

EMC-12

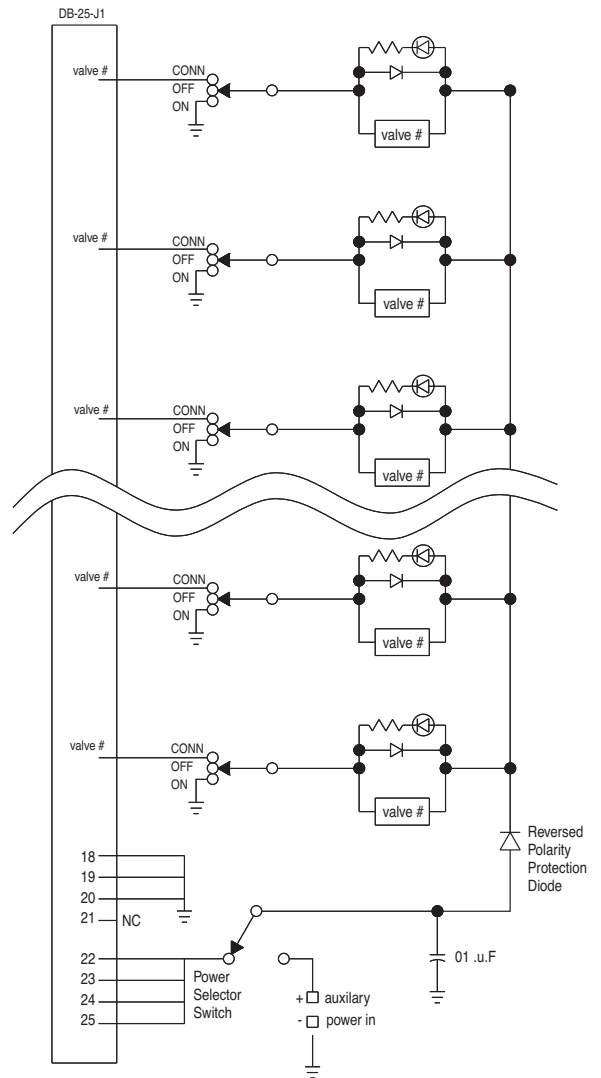
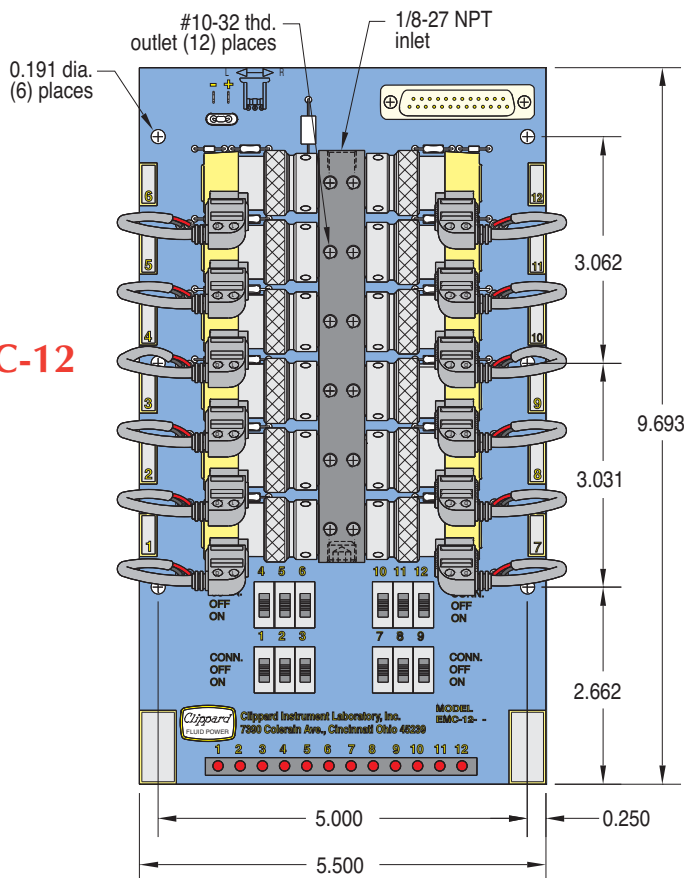

Wiring Diagram

Note: Manifold mounted valves are Normally-Closed. Use ETO models if exhaust must be ported. ETO models cannot be used "Normally-Open" without special piping.