

Directional Control Air Valves & Accessories

Keeping the world
moving and working.

 **ALKON**
CORPORATION



 **ALKON**
CORPORATION

Keeping the world
moving and working.

ENTREPRENEURIAL
CAPABLE
GLOBAL
CAN-DO
WORLD CLASS

At Alkon, we are committed to providing quality products for our customers' needs. Our valves can be found in applications as varied as eighteen-wheelers to amusement park rides. Why? Because our precision engineering, innovative manufacturing, and dedicated service convince our customers that at Alkon, we get it right.

ABOUT US The personal touch of a small company drives our world-class manufacturing operation. For our employees, meeting customer needs is the primary concern. We take the time to understand each job and client. We take the opportunity to provide each customer with products of superior quality and value. We take pride that strong relationships and outstanding products result in continued customer satisfaction. **Service. Satisfaction. Success.** This is Alkon's philosophy.

HISTORY Alkon Corporation began in Hawthorne, New Jersey as a start-up company, carrying a single line. Since its creation in 1950, the company, and its product line, has grown steadily. In 1999, the corporate headquarters moved to our current 70,000 square feet facility in Fremont, Ohio. Our line has expanded to include a wide variety of fittings, valves, and flow controls. An additional manufacturing facility in Mexico, Alkon-Mexico, partners with us in production of forgings and primary machining.

We are a privately held company. Many of our employees — from executives to shop employees — are shareholders. We are active in Alkon's growth and invested in Alkon's success.





QUALITY PLEDGE

Alkon Corporation is committed to robust quality and service through continuous improvement, innovative design, dependable delivery, and an emphasis on customer relations.



WARRANTY

Alkon Corporation warrants its products to be free of defects in material and workmanship when properly installed and maintained. No other warranty is implied or expressed. Alkon Corporation's liability for remedy is limited to replacement or repair at Alkon's sole discretion if the parts are returned under a valid RGA to us within 180 days of purchase. No allowance whatsoever will be made for repairs made by the purchaser nor will Alkon be liable for consequential or other damages or any expense incurred through the use of its products. The warranty is valid solely on products of current design.

Alkon Corporation is constantly upgrading its products. In keeping with this policy, Alkon Corporation reserves the right to change dimensions, designs and/or performance. These changes may be made at any time.

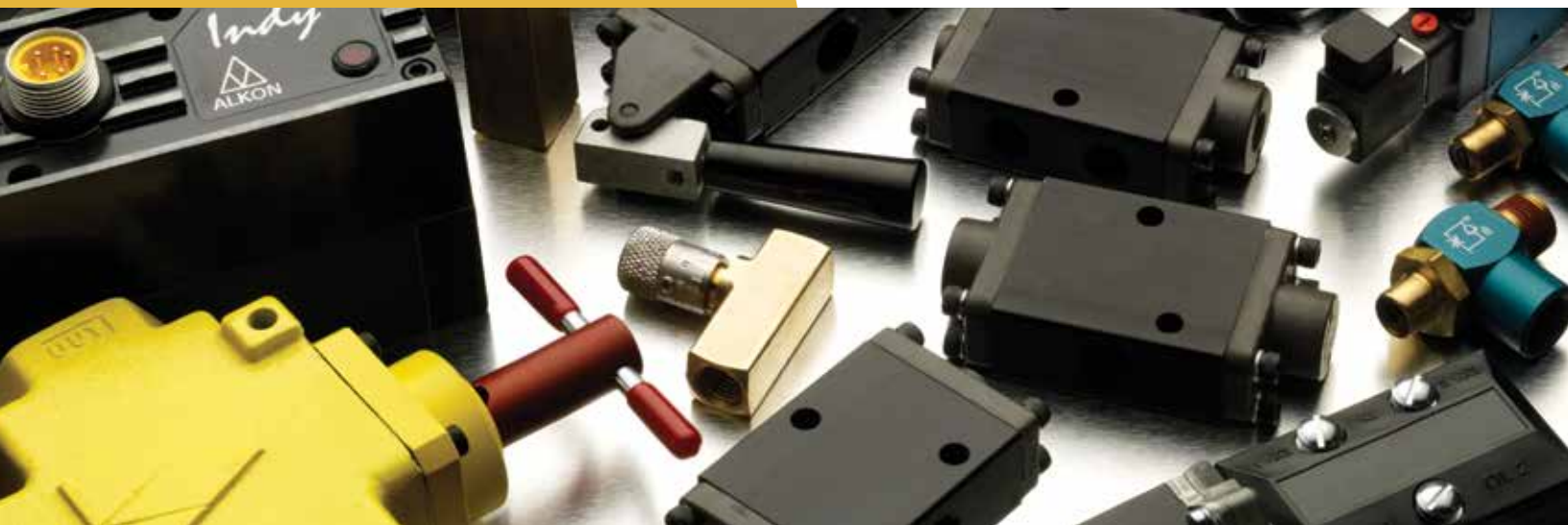

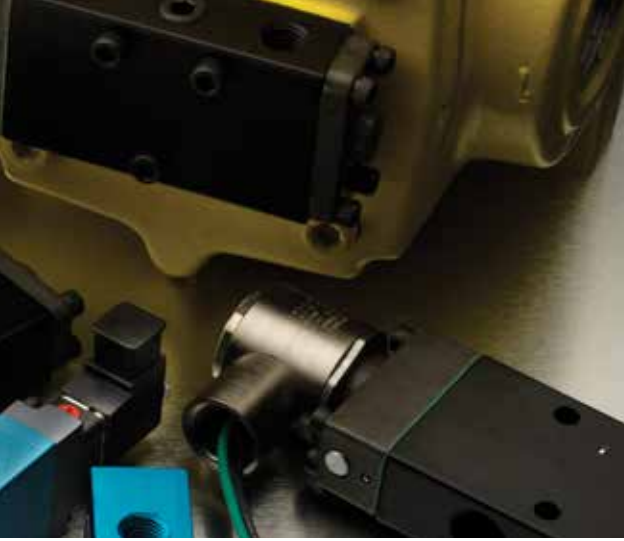

CAPABILITIES

Alkon's history — over fifty years of expertise in the valves industry — positions us to provide a vast array of services to our clients. From our role as a major U.S. manufacturer of brass push-to-connect (PTC) fittings, to our unique technologies for producing lapped spool valves, Alkon supplies what our clients need, when they need it.

Alkon's focus is to provide a quality product with an innovative design. We have the expertise and the technology to produce custom valves, from the design stage, through engineering to manufacturing. Unlike many of our competitors, we apply our own thread seal. Sealant material quality, and that of all incoming materials, must meet our high standards.

Alkon's state-of-the-art manufacturing facility can handle a variety of runs and processes to ensure that orders, no matter what size are met, and that processes are done with quality and care. We monitor inventory carefully, so that components are always available and changes in orders are accurate. Our custom storage units guarantee that orders are assembled efficiently and shipped on time.



Directional Control Air Valves & Accessories

Alkon valves are some of the fastest cycling and most reliable in the industry. We specialize in directional control air valves and valves specially designed for the transportation industry. We offer hundreds of options for one of the most complete valve product lines in the industry. So, every valve is made to order with ONLY the options you need. And with 100% product testing, we can guarantee performance.

TABLE OF CONTENTS

SERIES P VALVES	7
LAPPED SPOOL VALVES	7
SERIES P-FW/MW MINIATURE 3-WAY VALVES	8
SERIES P-MC 3-WAY VALVES	9
SERIES P-035 4-WAY VALVES	10
SERIES P-070 / P-140 4-WAY VALVES	11
SERIES P - 4-WAY VALVES	12
VALVE ACCESSORIES	13
SERIES A VALVES	14
SPRITE VALVE ACTUATOR & AIR PILOT	15
AIR BLEEDER OPERATED & INTEGRATED POWER PACKAGE	16
MANUAL & MECHANICALLY OPERATED	17
MULTIPLE STATION MANIFOLDS	17
SPRITE VALVES	19
FLOW CONTROLS	23
SERIES J VALVES	24
OMNI SERIES VALVES	26
OMNI 150 SERIES VALVES	30
OMNI 250 SERIES VALVES	33
OMNI 375 SERIES VALVES	40
STAINLESS STEEL 316 SERIES	55
LOC-MASTER™	57
MINI BAZOOKA LOC-MASTER®	58
BIG BAZOOKA LOC-MASTER®	58
“ELECTRO-LOC” LOC-MASTER®	59
MINI BAZOOKA	60
BIG BAZOOKA	62
INDY AU SERIES	64
DETROIT LINE	66



CONTACT US

Alkon Corporation Corporate Headquarters

USA Head Office

728 Graham Drive
Fremont, OH 43420

P: 419-333-7000
F: 419-355-9211

Alkon Products, S.A. de C.V.

Mexico Head Office

Destajistas No. 20
Parque Industrial Xhala
Cuautitlan Izcalli EDO. DE MEX.
C.P. 54730

P: 872-46-97
P: 872-58-09
F: 872-31-62

www.alkoncorp.com

sales@alkoncorp.com

LAPPED SPOOL VALVES

The heart of the Series P valve is the packless body and spool assembly constructed of aluminum with a ceramic hard aluminum oxide finish. This unique cartridge and spool assembly is completely isolated from external forces; is pressure balanced, allowing any port to be pressurized or subjected to back pressure with no effect on shifting force, and has been designed to meet the most stringent requirements that today's customers demand. All Series P valves are in-line, and all can be manifolded. This series is manufactured to the highest quality standards in the industry today and all carry a three year warranty on all parts of the valve, including the coil. No lubrication; extremely fast shifting coupled with very low minimum pilot pressure, a variety of options and all at a low cost.



Series P Spool Assembly

FILTRATION:

A 40 micron filter is recommended.

OPERATING PRESSURES:

- Internal Pilot (Standard): 10 P.S.I. to 150 P.S.I.
- External Pilot: Vacuum to 150 P.S.I.

NOTE: External Pilot Supply of at least 10 P.S.I. required for vacuum service.

MOUNTING:

All Series P Valves have no limitations as far as the orientation of the valve. Coils can be rotated in any direction for ease of installation.

CYCLE RATE:

Series P Valves may be cycled at over 2000 cycles per minute in most applications.

OPTIONS:

Include hard wired coils; factory assembly of valves to manifolds; a variety of plug connectors; pre-installed AQ push-in fittings, and many other popular options.

WARRANTY:

Series P valves are covered by a three year warranty from date of purchase. All provisions of our standard warranty policy (available upon request) apply.



Series P Valves

CONSTRUCTION:

- Body, End Caps & Manifolds: Anodized Aluminum
- Cartridge & Spool: Hard Coated Aluminum
- Coils: Molded Nylon
- O-Rings: Buna N (Nitrile)

LUBRICATION:

NONE REQUIRED — However a general purpose lubricating oil may be used if desired. In these cases, we recommend ASTM/ISO viscosity Grade.

SERIES A & SPRITE VALVES

Alkon Series A and SPRITE II valves have been designed to comply with the ever more stringent requirements for increased production rates through higher speeds and component reliability. The heart of these valves is a packless spool body and spool assembly constructed of aluminum with a ceramic hard aluminum oxide finish. Ground and matched to precision tolerances, its operation is virtually frictionless.



SPRITE & A Valves

Benefits of this packless design begin with the elimination of dynamic seals and their incumbent difficulties. Fast response allows increased machine cycle rates; non-lube operation reduces scheduled maintenance requirements. The body and spool assembly is pressure balanced, allowing any port to be pressurized or subjected to back pressure with no effect on spool shifting force. Exhaust port mufflers or speed controls may be used with no effect on valve response.

The unique body and spool assembly has been completely isolated from external forces by use of a patented 3-point suspension. This assembly, coupled with a complete variety of actuators and mounting alternatives, provides the highest level of performance and versatility found in the air valve industry.

VALVE FEATURES:

- Packless design
- Fast Response
- Operate with or without lubrication
- Can be sub-base, manifold or cylinder mounted

WARRANTY:

Series A & SPRITE are covered by a 90-day warranty. All provisions of our standard warranty policy (available upon request) apply.

SERIES P VALVES

SERIES P-FW/MW MINIATURE 3-WAY VALVES

PFW .085 Cv

PMW .160 Cv

GENERAL INFORMATION:

- Anodized Aluminum Body for a corrosion resistant, lightweight package
- Mount as a single station valve or stack into a manifold of up to 15 stations
- Options include hard wired coils, non-locking manual override and a variety of plug connectors
- Can easily be converted to a two way valve simply by plugging the exhaust port
- Coils can be rotated in 90° increments
- Choice of two flow models

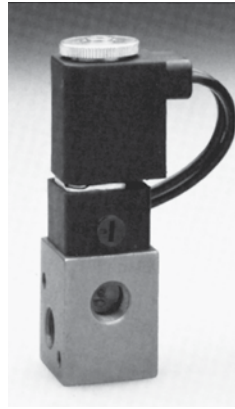

Miniature 3-Way Valves

SERIES P-FW/MW MINIATURE 3-WAY VALVES

PART #	A	B	C Sq.	D	E	F	G	H	J	K
P-FW1/MW1	.766	.422	1.000	.094	3.250	.562	.125	.500	1/8 NPT	1/8 NPT
P-FW2/MW2	1.000	.500	1.125	.125	3.593	.625	.125	.625	1/4 NPT	1/4 NPT

SIMPLE HOW-TO-ORDER INSTRUCTIONS

P-SERIES	FW1 MODEL	SS FUNCTION	115/60 VOLTAGE		NL OPTIONS
P	FW1	SS	6 VDC	24/60	NL – Non Locking Override
	FW2		12 VDC	115/60	N4 – Nema 4 Operator
	MW1		24 VDC	230/60	FA – Factory Assembly Stack (Specify # of Stations)
	MW2				

Plug Connections: See P-070/140 on Page 11.

FEATURES:

- Choice of 1/8 NPT or 1/4 NPT
- Standard Locking Type Manual Override
- Direct Acting Solenoid
- Three Year Warranty
- Bottom mounting holes

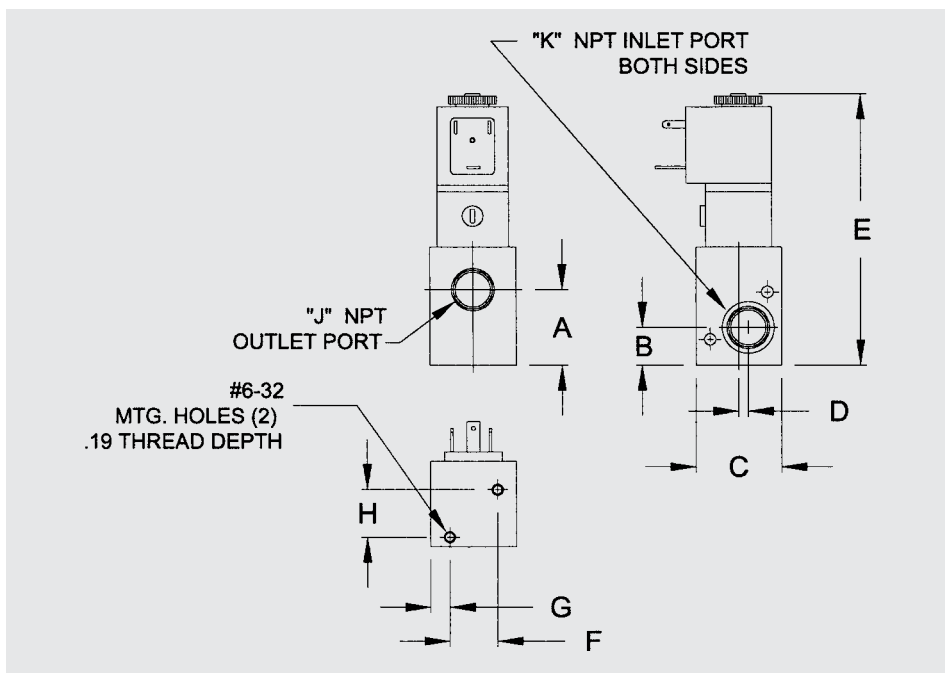

SPECIFICATIONS:

- Operating Temperature: 0° to 125°
- Operating Pressure: Vacuum to 150 P.S.I.
- Cv Rating: FW Cv .085 (Approx. 4 SCFM)
MW Cv .16 (Approx. 8 SCFM)
- Weight: Approximately 4.3 oz
- Normally closed

SERIES P-MC 3-WAY VALVES

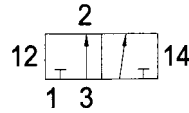

P-MC 3-Way Valve

GENERAL INFORMATION:

- Compact size
- Variety of combinations
- In line design - or mount on manifold
- Normally open or normally closed models
- 1/8 NPT or 1/4 NPT ports
- Cv - .5 (1/8") or .85 (1/4")
- Cycle Rate - Up to 2,500 per minute
- Standard locking manual override

MANIFOLDS:

- Available from 2 to 10 stations
- P-MC1: Part # 22029 - (# of stations)
- P-MC2: Part # 22046 - (# of stations)

BLOCKING PLATE:

- To block off manifold station
- P-MC1: Part # 22060
- P-MC2: Part # 22061

LOW WATTAGE SOLENOID:

Consult factory

SURGE SUPPRESSORS:

Consult factory

CONNECTORS:

- Part # 21876: Standard Connector
- Part # 21878: Standard Connector with pre-wired 3 ft. leads
- Part # 21905 - (): Lighted Connector (Voltage)
- Part # 21906 - (): Lighted Connector (Voltage) with pre-wired 3 ft. leads
- Part # 22076: Standard Connector with pre-wired 6 ft. leads

SIMPLE HOW-TO-ORDER INSTRUCTIONS:

P-M SERIES	C TYPE	1 SIZE	SS FUNCTION	115/60 VOLTAGE		HW OPTIONS
P	MC (NC)	1 (1/8 NPT)	SS - Single Solenoid	6 VDC	24/60	HW - Hard Wire Coil Leads
	MO (NO)	2 (1/4 NPT)	SP - Single Pilot	12 VDC	115/60	FA - Factory Assembly of Manifolds
				24 VDC	230/60	XP - External Pilot Supply Port

DIMENSIONS:

MODEL #	A	B	C	D	E	F	G	H	J	K	L
P-MC1	.961	4.25	1.188	1.56	.961	.500	1.75	.750	.218	.266	1/8
P-MC2	.961	4.25	1.375	1.88	.961	.500	1.875	1.00	.200	.400	1/4

MANIFOLDS:

MODEL #	A	B	C	D	E	F	G	H	J
P-MC1	.875	.812	2.562	.200	.812	2.00	.415	1.00	1/4
P-MC2	.968	1.063	3.00	.188	.812	2.00	.415	1.00	1/4

USE FOLLOWING VOLTAGE CODES:

For lighted connectors

6 VDC - 01	12 VDC - 02	24 VDC - 03
24/60 - 05	115/60 - 06	230/60 - 07

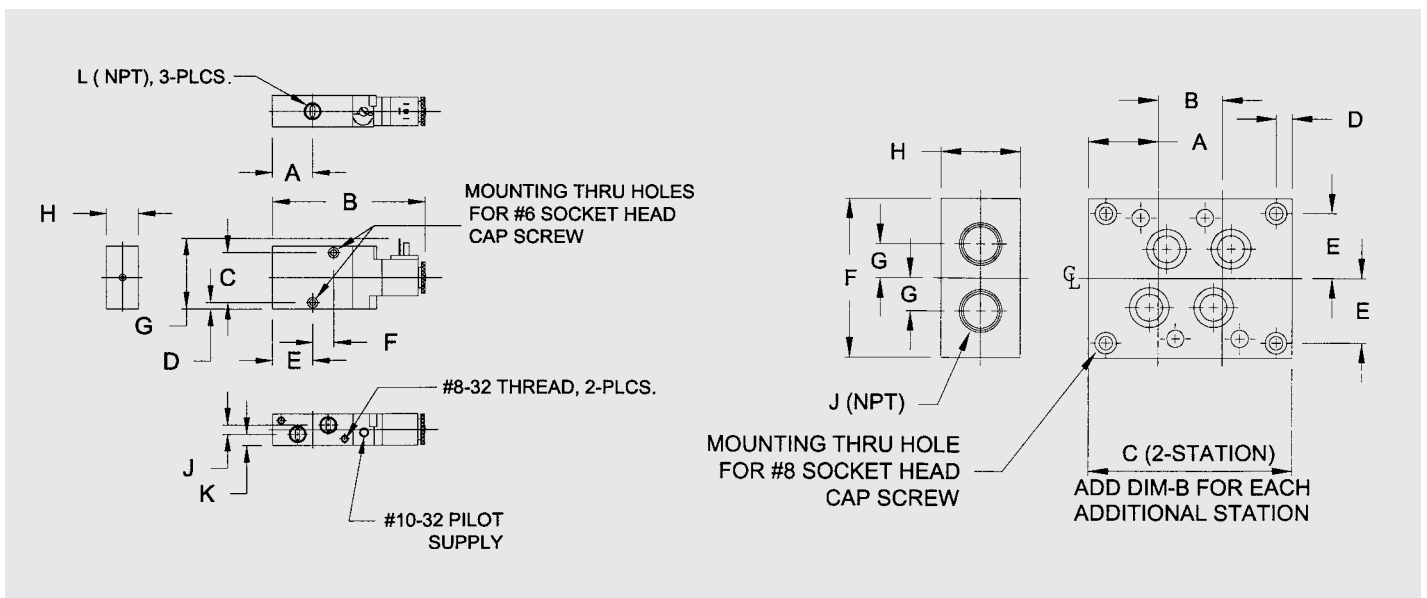

SERIES P VALVES

SERIES P-035 4-WAY VALVES

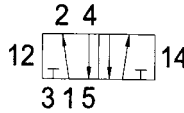

P-035 4-Way Valve

GENERAL INFORMATION:

- Compact size - Only 3/4" wide
- Multi purpose - use as a 4-Way or 3-Way
- In-line design - or mount on manifold
- Variety of models - solenoid or pilots
- 1/8 NPT Ports
- Cv - .40
- Cycle rate - Up to 2,500 per minute
- Standard locking manual overdrive

SIMPLE HOW-TO-ORDER INSTRUCTIONS:

P-SERIES	035 MODEL	SS FUNCTION	115/60 VOLTAGE		HW OPTIONS
P	035	SS (Single Solenoid)	6 VDC	24/60	HW – Hard Wire Coil Leads
		DS (Double Solenoid)	12 VDC	115/60	FA – Factory Assembly of Manifolds
		SP (Single Pilot)	24 VDC	230/60	XP – External Pilot Supply Port
		DP (Double Pilot)			
		3S (3 POS., DS, all ports blocked)			
		3P (3 POS, DP, all ports blocked)			

MANIFOLDS:

Available from 2 to 10 stations
Part # 21904 - (# of stations)

BLOCKING PLATE:

To block off manifold station
Part # 21908

INTERFACE PLATE:

For mounting a P-035 to a P-070 manifold -
Part # 21910

CONNECTORS:

- Part # 21876: Standard Connector
- Part # 21878: Standard Connector with pre-wired 3 ft. leads
- Part # 21905 - (): Lighted Connector (Voltage)
- Part # 21906 - (): Lighted Connector (Voltage) with pre-wired 3 ft. leads
- Part # 22076: Standard Connector with pre-wired 6 ft. leads

LOW WATTAGE SOLENOID:

Consult factory

SURGE SUPPRESSORS:

Consult factory

USE FOLLOWING VOLTAGE CODES:

For lighted connectors

6 VDC - 01	12 VDC - 02	24 VDC - 03
24/60 - 05	115/60 - 06	230/60 - 07



SERIES P-070 / P-140 4-WAY VALVES

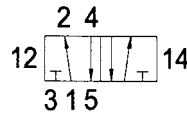

GENERAL INFORMATION:

- High flow Multi-Purpose Design
- Use as a 3-Way by plugging one port
- In line design - or mount on manifold
- Single or double solenoid or pilot
- Two or three position models available
- P-070: 1/4" Ports Cv - .8
- P-140: 3/8" Ports Cv - 1.5
- Cycle Rate - over 2,000 per minute
- Standard non-locking manual override
- Wide variety of popular options

P-070 4-Way Valve

SIMPLE HOW-TO-ORDER INSTRUCTIONS

P-SERIES	070 MODEL	SS FUNCTION	115/60 VOLTAGE		HW OPTIONS
P	070	SS (Single Solenoid)	6 VDC	24/60	HW – Hard Wire Coil Leads
	140	DS (Double Solenoid)	12 VDC	115/60	FA – Factory Assembly of Manifolds
		SP (Single Pilot)	24 VDC	230/60	XP – External Pilot Supply Port
		DP (Double Pilot)			LM – Locking Manual Override
		3S (3 POS., DS, all ports blocked)			N4 – NEMA 4 Operator
		3P (3 POS., DP all ports blocked)			

Consult factory for other available combinations

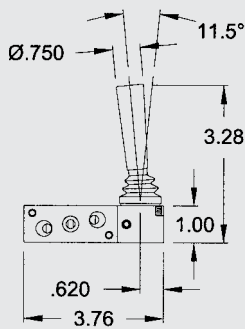

P-070 Hand Lever Valve

Part # P-070-HL

The P-070 is available in a Hand Lever Version that is compact and versatile. The standard is a spring return model that may be converted to a detented model simply by turning two Allen screws in the end cap.

MANIFOLDS:

- Available from 2 to 10 stations
- P-070: Part # 21821 - (# of stations)
- P-140: Part # 21907 - (# of stations)

BLOCKING PLATE:

- To block off manifold station
- P-070: Part # 21822
- P-140: Part # 21909

SURGE SUPPRESSORS:

Consult factory

CONNECTORS:

- Part # 21823: Standard Connector
- Part # 21839: Standard Connector with pre-wired 18" leads
- Part # 21824 - (): Lighted Connector (Voltage)
- Part # 21840 - (): Lighted Connector (Voltage) with pre-wired 3 ft. leads
- Part # 21852: 1/2 NPT Conduit Connector
- Part # 21841 - (): Connector (Voltage) with molded 3 ft. leads
- Part # 21842 - (): Lighted Connector (Voltage) with molded 3 ft. leads
- Part # 22078: Standard Connector with pre-wired 6 ft. leads

USE FOLLOWING VOLTAGE CODES:

For lighted connectors

6 VDC - 01	12 VDC - 02	24 VDC - 03
24/60 - 05	115/60 - 06	230/60 - 07



SERIES P VALVES

SERIES P - 4-WAY VALVES

MANIFOLD ASSEMBLY:

Manifolds can be purchased separately or valves can be assembled to them at the factory.

Hardened mounting pins (2) are screwed into the valve body (5) until flush, and then the valve unit is inserted into the manifold block (4) after positioning the O-rings (1). By tightening the Allen head screws (3), the valves are seated and connected to the manifold block. This unique method assures a leak proof assembly. When manifolds are purchased separately, each kit contains mounting pins, set screws and O-rings for the purchased number of stations.

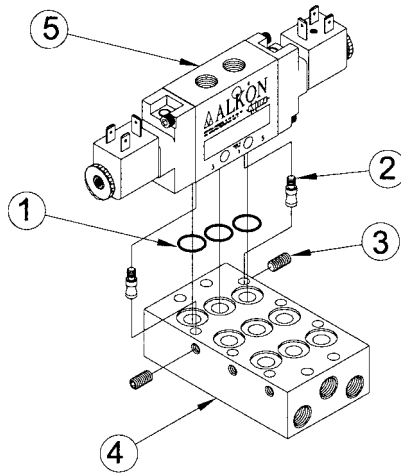

RESPONSE

MODEL TYPE	TIME TO ENERGIZE	TIME TO DE-ENERGIZE
A.C. SOL.	7 MS	18 MS
D.C. SOL.	10 MS	18 MS
PILOT	6 MS	N/A

ELECTRICAL CHARACTERISTICS

VOLTAGE	INRUSH (AMPS)	HOLDING (AMPS)	NOMINAL POWER CONSUMPTION
6VDC	.240	.240	2.9W
12VDC	.240	.240	2.9W
24VDC	.108	.108	2.6W
24/60	.340	.210	3.8W
115/60	.070	.044	3.8W
230/60	.040	.024	3.8W

REPLACEMENT COILS

VOLTAGE	P-035 - P-MC STANDARD	P-070/140 - P-FW HARD WIRE	P-MW STANDARD	HARD WIRE	STANDARD	HARD WIRE
6 VDC	21874-01	21875-01	21832-01	21833-01	22071-01	22065-01
12 VDC	21874-02	21875-02	21832-02	21833-02	22071-02	22065-02
24 VDC	21874-03	21875-03	21832-03	21833-03	22071-03	22065-03
24/60	21874-05	21875-05	21832-05	21833-05	22071-05	22065-05
115/60	21874-06	21875-06	21832-06	21833-06	22071-06	22065-06
230/60	21874-07	21875-07	21832-07	21833-07	22071-07	22065-07

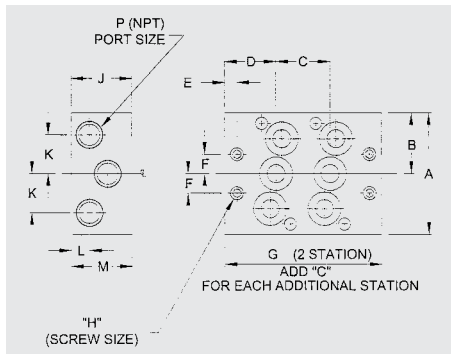

MANIFOLDS

MODEL#	PART#	A	B	C	D	E	F	G	H	J	K	L	M	P
P-035	21904	2.50	1.25	.812	.938	.250	.390	2.688	#6	1.000	.781	.344	.656	1/4
P-070	21821	2.50	1.25	1.125	1.062	.250	.400	3.250	#8	1.250	.800	.500	.875	1/4
P-140	21907	3.00	1.50	1.375	1.344	.344	.461	4.062	#10	1.750	.922	.594	1.156	3/8

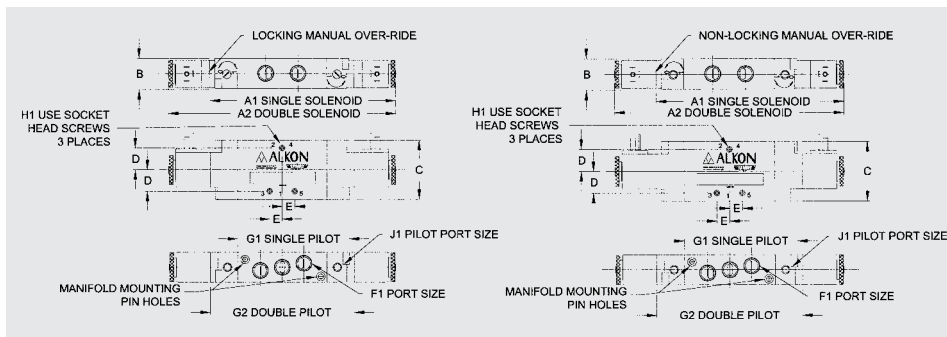

DIMENSIONS

MODEL #	A1	A2	B	C	D	E	F1	G1	G2	H1	J1
P-035	4.58	6.88	.750	1.50	.594	.325	1/8 NPT	2.77	3.26	#4	10-32
P-070	5.16	7.80	1.00	2.00	.750	.359	1/4 NPT	3.14	3.75	#6	1/8
P-140	6.01	8.77	1.25	2.50	1.00	.435	3/8 NPT	3.99	4.73	#8	1/8



CONNECTORS:

In addition to the standard connectors and coils shown (see individual valve packages for part numbers), we also offer custom configurations such as different length cords, lighted wafers, light adapters, green or red LED's, and a variety of others. Contact your local Alkon distributor for more information.

VALVE ACCESSORIES

The dual exhaust and balanced design of the Alkon valve allows for the use of inexpensive exhaust metering valves. When screwed into the exhaust ports, they independently control the actuator speed in either or both directions.

Metering valves have aluminum bodies and steel adjusting screws.

Mufflers are used to silence the noise caused by exhausting air. Both standard mufflers and speed control mufflers are made of brass and sintered bronze.

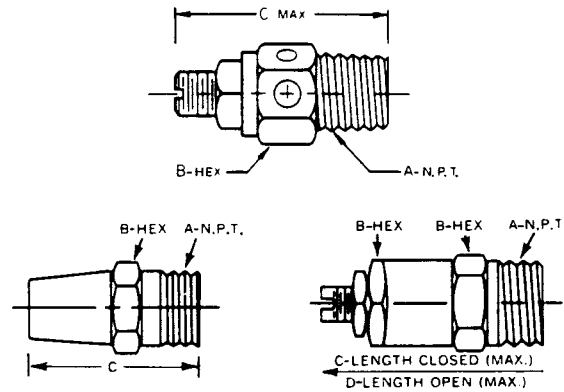

MODEL NO.	DESCRIPTION	WEIGHT	DIMENSIONS				Cv FACTOR
			A	B	C	D	
6661	1/4 NPT Metering Valve	1/2 oz.	1/4	.562	1.437	-	1.00
7985	3/8 NPT Metering Valve	1 oz.	3/8	.687	1.812	-	1.55
ER-50	1/2 NPT Metering Valve	4 oz.	1/2	.875	2.0	-	1.75
40A01081	#10-32 Exhaust Breather	1/2 oz.	10-32	.312	.40	-	.20
9516-1	1/8 NPT Muffler	1 oz.	1/8	.437	1.125	-	.52
9516-2	1/4 NPT Muffler	2 oz.	1/4	.562	1.375	-	1.10
9516-3	3/8 NPT Muffler	3 oz.	3/8	.687	1.500	-	1.60
9516-4	1/2 NPT Muffler	4 oz.	1/2	.875	1.875	-	3.20
9516-6	3/4 NPT Muffler	5 oz.	3/4	1.062	2.250	-	5.10
9516-8	1 NPT Muffler	6 oz.	1	1.312	2.875	-	10.0
9564-1	1/8 NPT Speed Control Muffler	2 oz.	1/8	.562	1.375	2.000	.59
9564-2	1/4 NPT Speed Control Muffler	3 oz.	1/4	.625	1.562	2.187	.77
9564-3	3/8 NPT Speed Control Muffler	4 oz.	3/8	.687	1.875	2.813	1.31
9564-4	1/2 NPT Speed Control Muffler	5 oz.	1/2	.875	2.250	3.312	2.60
SCS-34	3/4 NPT Speed Control Muffler	7 oz.	3/4	1.062	2.375	-	4.80
SCS-100	1 NPT Speed Control Muffler	9 oz.	1	1.312	2.500	-	8.50



SERIES A VALVES

SERIES A VALVES

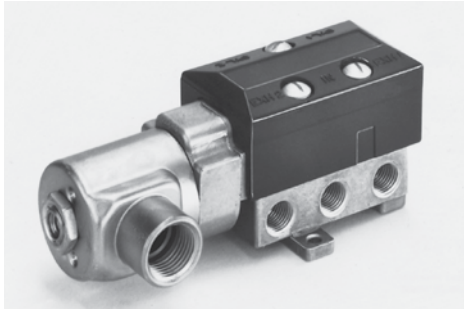

Model 7900 – Single Horizontal Solenoid / Pilot Operated

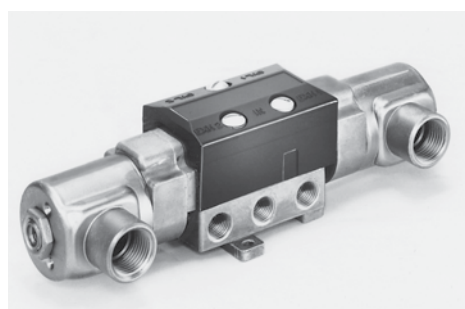

Model 7980 – Double Horizontal Solenoid / Pilot Operated

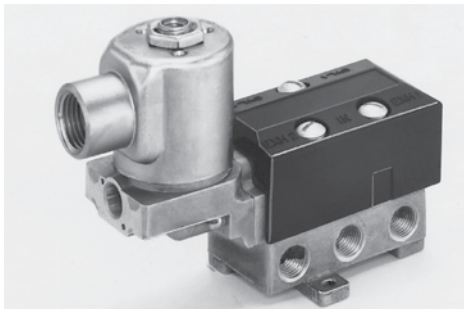

Model 8060 – Single Vertical Solenoid / Pilot Operated

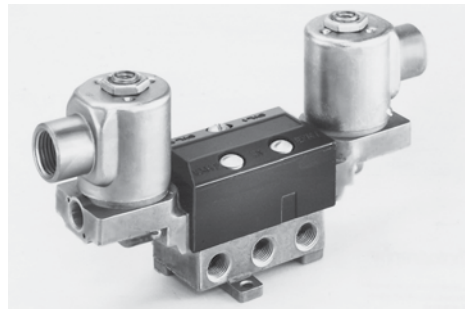

Model 8065 – Double Vertical Solenoid / Pilot Operated

Horizontal

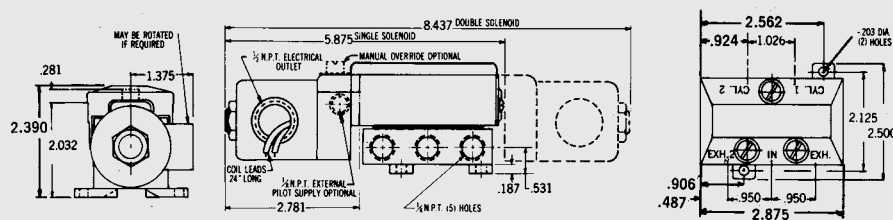

Vertical

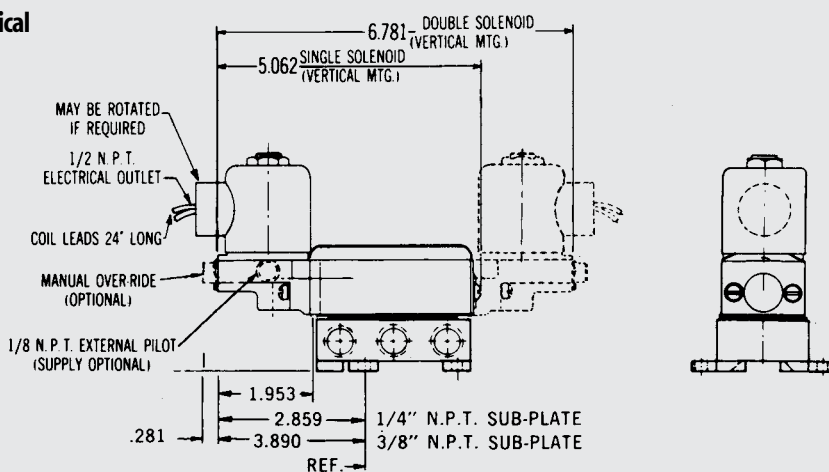

Solenoid Controlled / Pilot Operated

Reliable rapid response is inherent to the Series A valve's design concept. The low friction operation, short spool travel and low mass spool all represent construction features that make fast response possible.

Equally important, this fast response is repeatable. It does not fluctuate when degree of lubrication, operating pressure or internal valve back pressure vary.

Fast, repeatable response translates into immediate benefits for the machine designer. Now, machine cycle rates can be increased to match the valve's instant response to control signals.

Horizontal and Vertical Solenoid Operation

Solenoid/Pilot operators are available in either horizontal or vertical configurations to accommodate varying space limitations.

The horizontal model is usually used for sub-base and cylinder mounting; the vertical for manifold mounting since it provides access to the manifold's side cylinder ports.

Series A solenoid operators offer a wide variety of voltages and frequencies; all coils are continuously rated and continuous cycle rates up to 300 CPM can be maintained.

OPTIONS:

- Molded coils
- Locking type manual override
- Two position detent (adds 5/8" to overall length)
- 1/4 NPT threaded pilot exhaust adapter
- External pilot supply

NOTE: Three position open or closed center valves are available as special assemblies. Consult factory.

SPRITE VALVE ACTUATOR



Model A 7902
Single Solenoid Pilot Operated



Model A 7982
Double Solenoid Pilot Operated

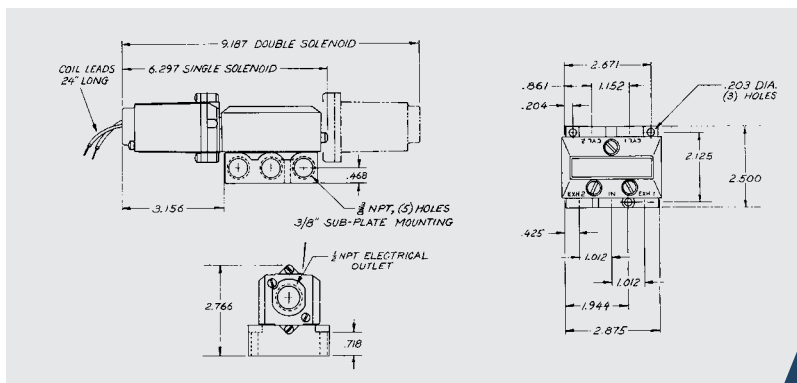

SPRITE solenoid/pilot operators are available for single or double actuation applications in horizontal configurations.

The SPRITE actuator offers lapped spool reliability in both valve and operator, providing a maintenance-free product life measured in multi-millions of cycles currently unobtainable from standard pilot/solenoid operators.

Offered in a wide variety of voltages and frequencies; all coils are rated for continuous or maintained signal service and continuous repeatable cycle rates in excess of 3000 CPM are possible. Molded coils are standard and solenoid housings meet most JIC and NEMA IV criteria. Non-locking manual override is standard.

OPTIONS:

- Two position detent (adds 5/8" to overall length)

NOTE: Three position open or closed center valves are available as special assemblies. Consult factory.

AIR PILOT



Model 7984
Single Pilot Operated



Model 7986
Double Pilot Operated

In applications where electrical controls are not suitable, or where they are hazardous, air pilot operated valves can be used. These valves can also be applied for special purpose circuitry such as sequencing or timing operations.

Since the low friction characteristics of the body and spool assembly requires only .50 psig to shift, vacuum can be considered as a signal source. Air pilot operated valves, do however require external valves to supply the required signal pressure.

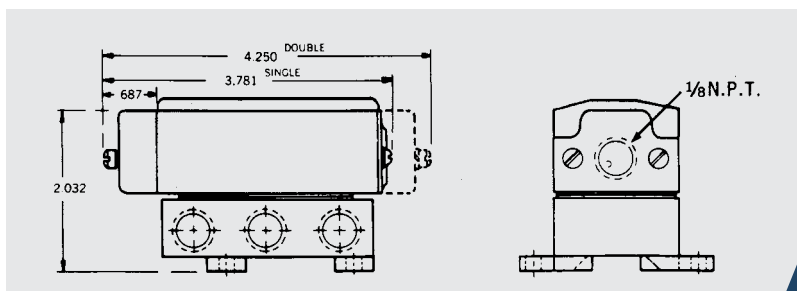

OPTIONS:

- Two position detent (adds 5/8" to overall length)

NOTE: Three position open or closed center valves are available as special assemblies. Consult factory.

SERIES A VALVES

AIR BLEEDER OPERATED

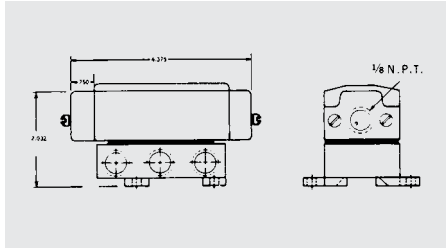
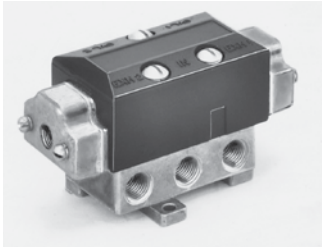

Model 7919
Air Bleeder Operated

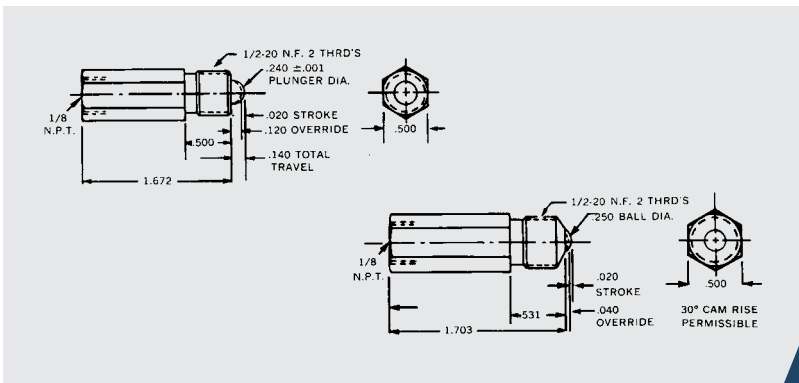

Bleeder Operated

Both air pilot and bleeder operated valves can be applied when electrical control is impractical or hazardous. The bleeder can be used in place of the air pilot model where limited space prohibits the external pilot pressure supply required by the external pilot control valves.

Bleeder Operators

#6000, Plunger type bleeder operator is used when striking force is straight on. #8492, Ball type bleeder operator has a hardened ball for cam actuation.

OPTIONS:

- Two position detent (adds 5/8" to overall length)

INTEGRATED POWER PACKAGE

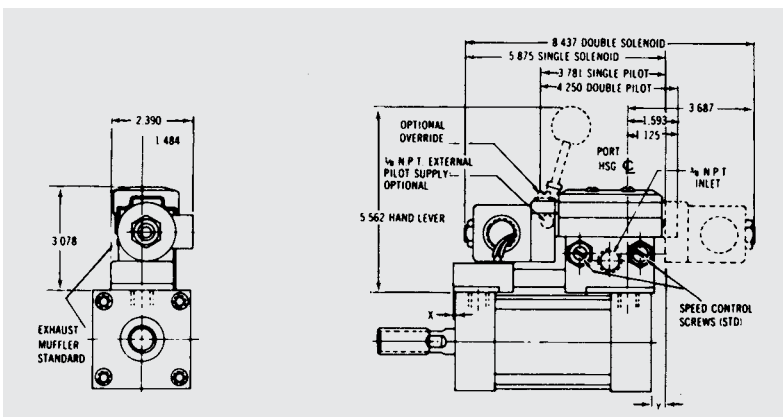

The integrated power package is a sub-base assembly in which the Series A valve is assembled directly to any square head tie rod type air cylinder.

Since only one air supply connection is required, assembly times can be greatly reduced. AC sub-bases include metering valves and muffler to keep the Integrated Power Package a neat, compact cylinder and valve combination. The AC valve increases the overall height of the cylinder by only 3 inches.

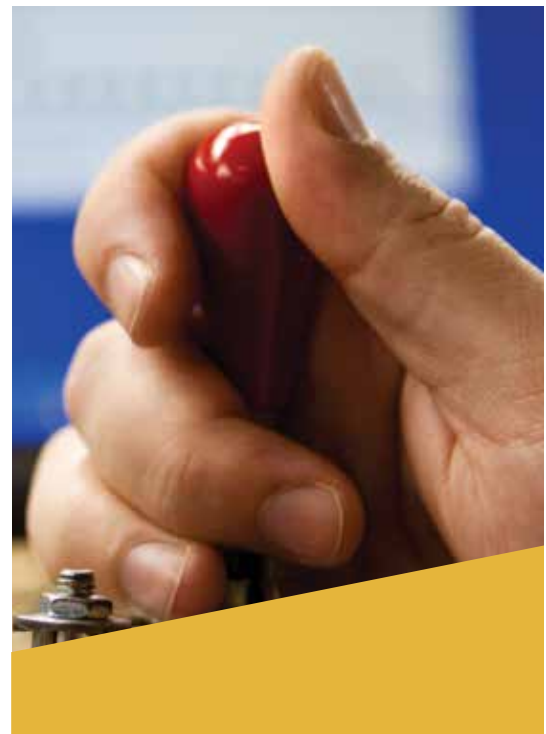

MANUAL & MECHANICALLY OPERATED

Available with either hand, foot or palm button actuators, manually operated Series A valves can be used directly as power valves to control air actuators or indirectly to operate larger pilot operated hydraulic or pneumatic valves. Hand or foot operated models are available with spring offset or with optional two position detent.

Three position, spring centered or detented, open or closed center hand valves are available as special assemblies. Consult factory.

Actuating force of palm button is only 2 lbs.

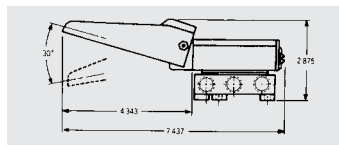
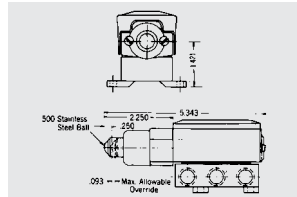
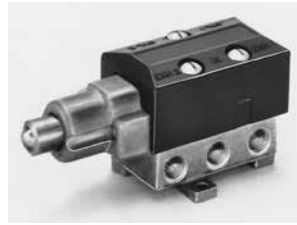
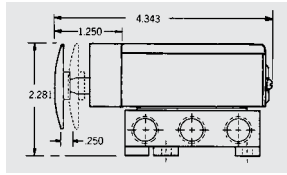
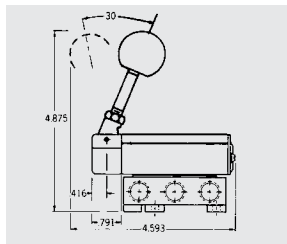

Mechanically Operated

The mechanically operated Series A is a ball cam operated valve. It can be used as a power valve to control air actuators or to control larger pilot operated hydraulic or pneumatic valves.

- Stroke: .250"
- Shifting force: 3.85 lbs. minimum
- Allowable override: .093 with 10.4 lb. maximum force
- Maximum allowable cam rise: 30° (including 1/32 override)



Multiple Station Manifolds

MULTIPLE STATION MANIFOLDS

Series A valves may be manifold mounted in a flexible arrangement which allows the stacking of any number of valves in any combination of actuators. With multiple manifold assembly, only one inlet connection is required for the entire manifold assembly.

The exhaust port on the manifold is also common to all valves in the assembly. Both inlet and exhaust ports are 1/2 NPT. Cylinder ports are available in either 1/4 or 3/8 NPT. All manifold bases are provided with side and bottom cylinder ports and are shipped with the bottom cylinder ports plugged unless otherwise specified.

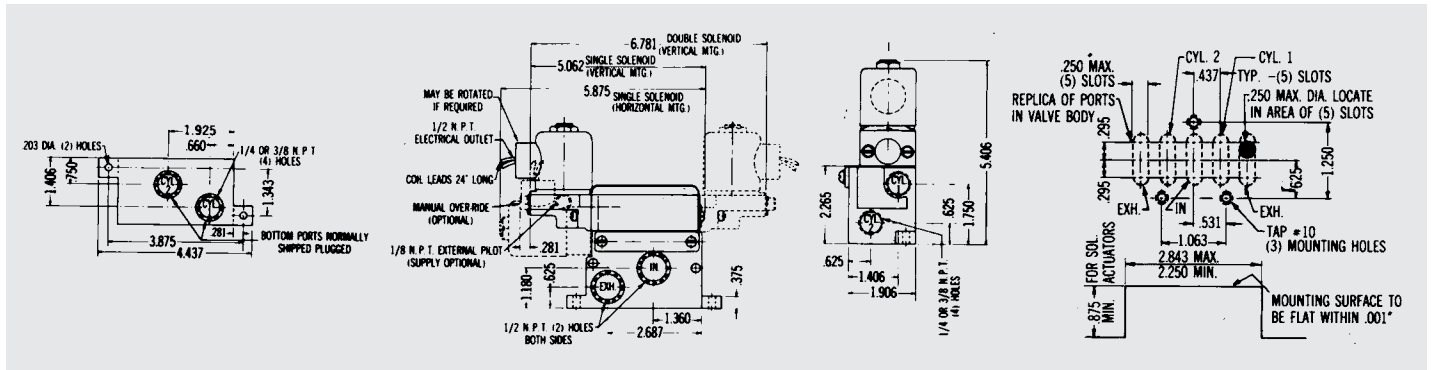

SERIES A VALVES

SOLENOID / PILOT VALVE SPECIFICATIONS

- Operating Pressure (std.): 20 - 175 psig
- Operating Pressure (with optional external pilot supply: Vacuum - 250 psig)
- Maximum allowable cycle rate: 300 CPM (to 600 CPM under specified conditions)
- Maximum heat rise: 85° C

RESPONSE CHARACTERISTICS

SIZE	MODEL TYPE	TIME TO SHIFT IN MILLI-SECONDS*	TIME TO FILL 10 IN 3 CHAMBER TO 80 PSI	DE-ENERGIZATION	
				START TO UNLOAD	UNLOAD TO 20 PSI**
1/4"	Single Sol.	9	22	22	33
Sub-base	Double Sol.	9	20	10	30
3/8"	Single Sol.	9	21	20	31
Sub-base	Double Sol.	9	19	10	29

* Represents time in milliseconds from solenoid actuation to first recorded pressure in chamber. At cylinder port itself, solenoid pilot valves required a maximum of 8 milliseconds.

** Represents time from first recorded pressure decay in chamber to unloading down to 20 psig from 100 psig initial pressure.

ELECTRICAL CHARACTERISTICS

VOLTAGE	INRUSH (Ma)	HOLDING (Ma)	NOMINAL POWER CONSUMPTION
6VDC	—	1830	12 watts
12VDC	—	790	12 watts
24VDC	—	396	12 watts
24/60	1250	835	12 watts
115/60	261	174	12 watts
230/60	130	87	12 watts

Cv Valves

MOUNTING TYPE	Cv VALVE
1/4" Sub-base	1.41
3/8" Sub-base	1.59
1/4" Manifold	1.52
3/8" Manifold	1.57

GENERAL SPECIFICATIONS

Flow Characteristics

Airline Preparation: The Series A valve may be used with dry or lubricated filtered air.

Installation: Valve body to sub-base screws should be torqued no more than 24 in. /lb.

Flow curves shown are for the 1/4" sub-base mounted valves. For 3/8" sub-base, 1/4" or 3/8" manifold valves use the noted correction factors, (CF).

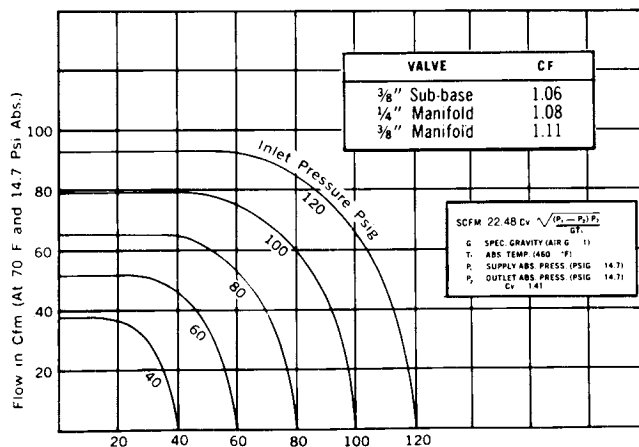

HOW TO ORDER SERIES A VALVES

A	A	7900	3/8	115/60	MC	
Series "A" Pneumatic Directional Valve	Mounting	Valve Model (See Pages 14-16)	Size	Voltage (If Applicable Specify)	Options	Code
	A Sub-base		Sub-base		2 Position Detent	2P
	M Multiple-Manifold		1/4"		External Pilot	XP
	C Cylinder		3/8"		Exhaust Adp.	EA
			Multiple		Molded Coil	MC
			Manifold		Less Sub-base	LS
			Cylinder		Less Coil	LC
			Mounted		Manual Override	MO
			Valves			
			3/8"			
			1/2"			

NOTES:

- Valves as ordered above will be shipped assembled to sub-base or manifold called out.
- If no base is required specify option code LS in appropriate area of model number.
- If coil voltage is not specified, std. 115/60 will be furnished.
- Cylinder mount sub-base is furnished with 12" transfer tube as standard.

3 & 4-WAY AIR VALVES THAT BRING A NEW CONCEPT TO AIR VALVE DESIGN

The SPRITE II is truly a unique miniature solenoid air valve. It brings a technology to pneumatic control that through the years has proven on-the-job reliability in the small electrical relay field. This proven technology of solenoid actuation, and Alkon's time tested lapped spool valve elements combine as the basis of the exciting SPRITE II valve.

The SPRITE II valve has been specifically designed to bring a higher level of reliability to pneumatic equipment, and at the same time a new level of versatility to system design.

- Sub-base mounted. Same valve assembly may be used alone on its own sub-base or in compact multifunction manifolds
- Simple operation
- Operates with or without line lubrication
- Working pressures to 125 psi
- Continuous duty solenoids
- Integral locating pin for fool-proof valve alignment to sub-base or manifold
- Simple sub-base mounting from top or bottom

An Incredible Response Time & Cycle Rate

Amazing as it seems, the SPRITE II valve can be continuously cycled as fast as alternating current itself – thirty-six hundred times per minute. Of course, that's far beyond practical cylinder speed, but it does make a point about the valve's capabilities.

Equally impressive is the response time – from closed to full open in just 6.0 milliseconds. That in itself is quite out of the ordinary.



SPRITE Valve



SPRITE VALVES

SIMPLE, WEAR-FREE OPERATION

The extraordinary performance of SPRITE II valves is made possible by two major characteristics:

1. Exceedingly simple operation that eliminated points of wear or fatigue.
2. A virtually frictionless precision matched body and spool assembly that requires only minimal force to shift.

The solenoid operator itself consists of a lightly hinged mechanical operating arm (armature) that is held in position by a low tension spring. With the armature in its spring held position, a second light spring holds the spool in its normal position. When the solenoid is energized, the current creates a magnetic effect on a protruding steel core, which in turn draws the armature toward it. When the solenoid is de-energized, spring force returns the pressure balanced spool to its original position.

The mass of the SPRITE II armature is negligible compared to conventional T-bar or poppet type. This low mass, plus the small, highly efficient magnetic gap, give the SPRITE II its exceptional performance characteristics.

SPECIFICATIONS

SPRITE II is a direct solenoid operated spool valve, with a short stroke, and packless design, for 3 or 4-Way applications. It may be continuously operated with or without line lubrication, and mounted in any position. It is a sub-base mounted valve. All solenoids are rated for continuous duty.

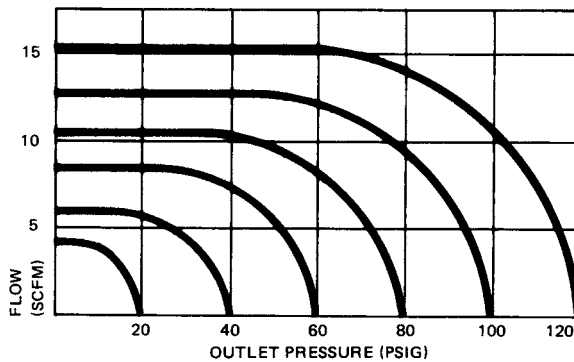

$$C_v = .23$$

$$SCFM = 22.48 C_v \sqrt{\frac{(P_1 - P_2) P_2}{G \cdot T_1}}$$

G=SPECIFIC GRAVITY (AIR G=1)
 T₁=ABS. TEMP. (460° F.)
 P₁=SUPPLY ABS. PRESS. (PSIG + 14.7)
 P₂=OUTLET ABS. PRESS. (PSIG + 14.7)

Solenoid Data

All solenoid coils are furnished with 24 inch leadwire connections. Coils are varnished in conformance with MIL-V-173.

All voltages shown below are furnished at no extra cost. For other voltages consult factory. AC coils may be used for either 50 cycle or 60 cycle service.

VOLTAGE	AMPERAGE (MILLI-AMPS)	WATTAGE
6VDC	460	2.8
12VDC	230	2.8
24VDC	115	2.8
12VAC/50-60Hz	1,600	800
24VAC/50-60Hz	800	400
115VAC/50-60Hz	160	80
230VAC/50-60Hz	80	40

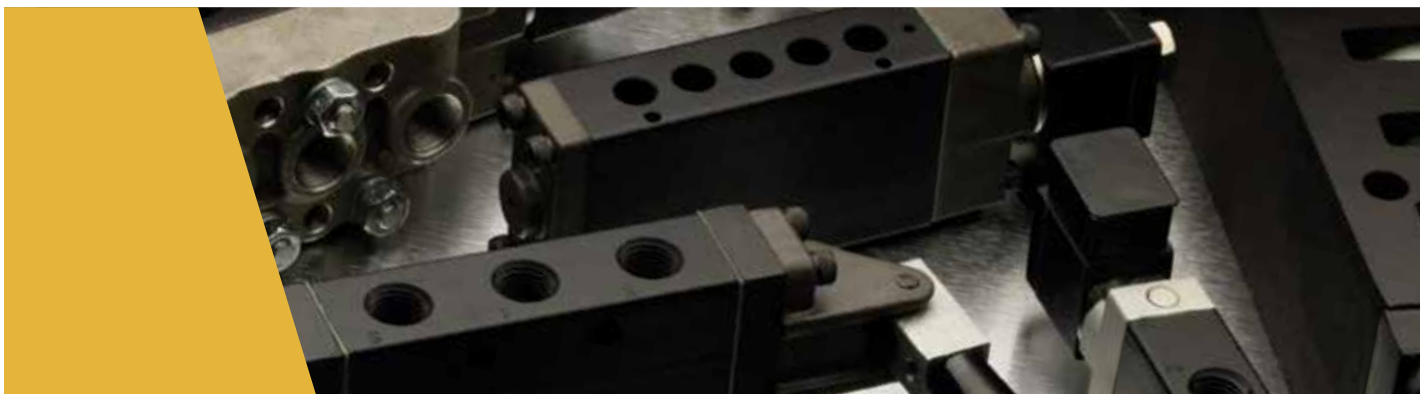

IT HAS CONSTRUCTION EXTRAS, TOO

SPRITE II is simply an outstanding valve package designed and constructed with a lot of attention to detail, like the spool which is precision machined to form extremely sharp land edges. This in turn gives the valve self-cleaning properties and reduces the stroke required for full flow.

You'll notice, too, that the spool and body are designed as a floating sub-assembly within the valve's protective housing to keep exterior forces from disturbing its precision operation.

The solenoid cover itself meets the latest industry standards – remove it and the solenoid comes with it, rendering the valve inoperative. Captive assembly bolts eliminate the possibility of lost parts in disassembly.

Complete corrosion resistance with aluminum and plated steel internal parts. One hundred percent functional testing of every valve that leaves the factory.

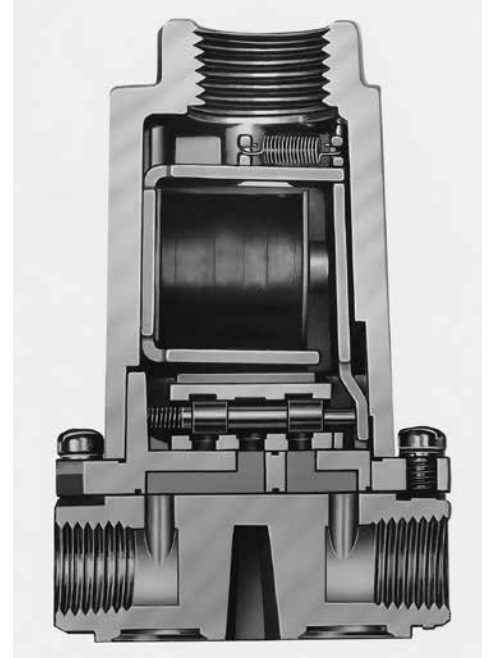

PRESSURE RATING:	125 PSI
RESPONSE TIME*:	6.0 Milliseconds
Cv RATING:	0.23
FILTRATION:	10 micron filter recommended
LUBRICATION:	Line lubrication optional, but not necessary

*AC Coils – DC Coils are somewhat slower, but response time may be improved by the use of a Controllable Overvoltage Supply.

HOW TO ORDER SPRITE II VALVES

2	39	R2	115/60	4S
Series "2"	Valve Function	Single Solenoid Spring Return "R2"	Voltage	Options
	When Sub-Base Mtd.		6VDC	MM = Multiple Manifold
	"39" = 3-Way N.C. & N.O. Multi-Function		12VDC	4S = 1/4" Side Ported Sub-Base
	"40" = 4-Way		24VDC	4B = 1/4" Bottom Ported Sub-Base
			24V/50-60 Hz	8B = 1/8" Bottom Ported Sub-Base
			115V/50-60 Hz	
			230V/50-60 Hz	

NOTES:

- Non-Locking Manual Overrides – Standard
- Valves and bases will be shipped separately unless "Factory assembly" is specified on the order.

SPRITE VALVES

Single Sub-base Mounting

Between the valve and the sub-base is a locating pin which assures accurate alignment of valve and sub-base. Valves are secured with two mounting screws.

The mounting of this valve may be achieved by one of two methods:

1. Sub-base may be bulkhead mounted using 1/4-20 threaded mounting holes on the bottom of the sub-base.
2. The same holes are counter-bored from the top of the sub-base to accept #8 screws for surface mounting.

Valves and sub-bases may be ordered separately; however, factory assembly is available at a nominal charge.

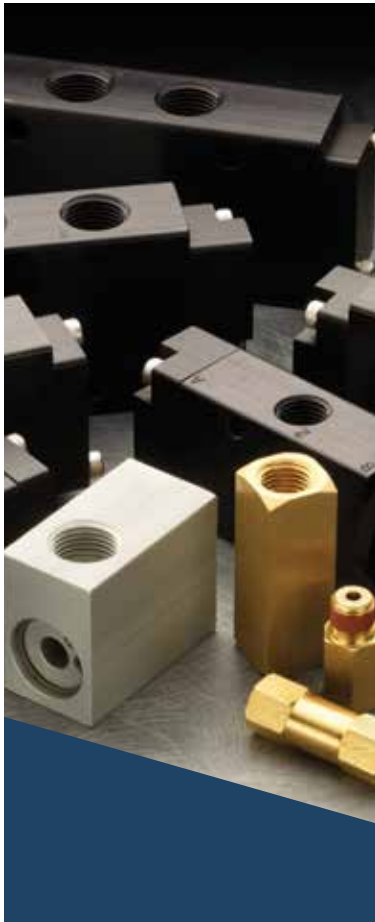
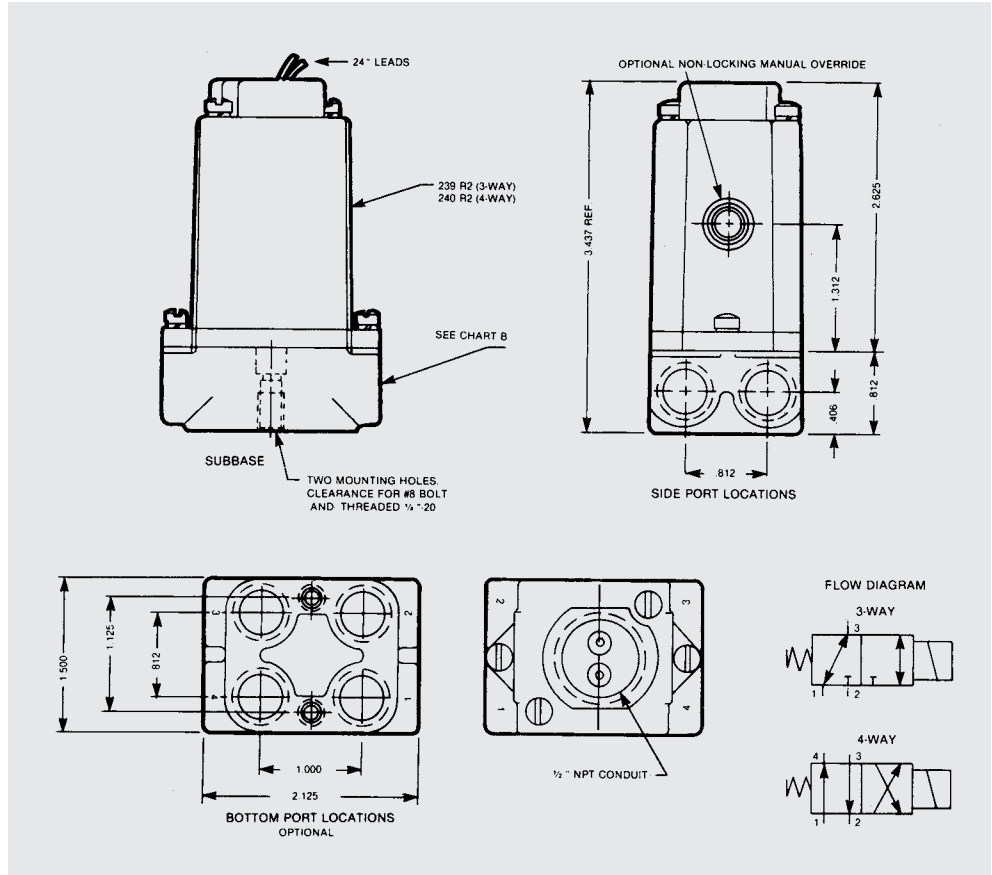

CHART A

OPERATION	PORT IDENTIFICATION			
	1	2	3	4
3-Way Normally Open	Inlet	Exhaust	Cylinder	-
3-Way Normally Closed	Exhaust	Inlet	Cylinder	-
3-Way Diverter	Cylinder	Cylinder	Inlet	-
4-Way Common Exhaust	Inlet	Exhaust	N.C. Cylinder	N.O. Cylinder

CHART B

SUB BASE PORTING		
BASE MODEL #		DESCRIPTION
3-WAY	4-WAY	
231S	241S	Side Ported, 1/8 NPT
232S	242S	Side Ported, 1/4 NPT
231B	241B	Bottom Ported, 1/8 NPT
232B	242B	Bottom Ported, 1/4 NPT

FLO-SET CONTROL VALVES

Flo-Set flow controls are an effective and accurate means of controlling the speed of pneumatic cylinders. They can easily be mounted in-line anywhere in your system.

A controlled setting of the exhaust port of the cylinder allows a set-back pressure to smoothly control piston velocity. They are recommended for all pneumatic applications to 150 PSI.

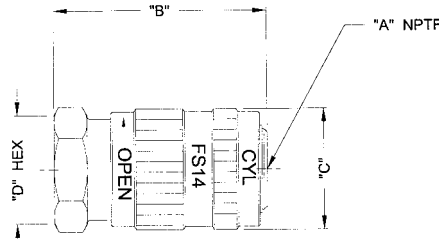

FLO-SET FLOW CONTROL VALVE

MODEL NUMBER	A		B		C		D	
	NPT	INCHES	MM	INCHES	MM	INCHES	MM	
FS14	1/4	2	50.8	1-1/16	27.0	1	25.4	
FS38	3/8	2-29/32	73.8	1-3/8	34.9	1-1/16	27.0	
FS12	1/2	3-13/32	86.5	1-11/32	42.9	1-3/8	34.9	
FS34	3/4	4-9/32	108.7	2-1/8	28.6	1-3/4	44.5	

DESIGN FEATURES:

- Easily mounted for in-line applications
- Anodized aluminum for corrosion protection
- Knurled sleeve for non-slip adjustment
- Precision fit so vibration will not change adjusted setting
- Excellent controlled flow and high free flow
- For sizes 1/4, 3/8, 1/2 and 3/4 NPT

MODEL NUMBER	NPT SIZE	CONTROLLED FLOW 0 TO MAX. SCFM	FREE FLOW CONTROL ADJ. MAX. SCFM	Cv	SCHEDULE 40 PIPE SCFM	AIRPRESS. PSI
FS14	1/4				1/4 x 2 Nipple	
		30	43		81	40
		39	62	1.1	114	60
		54	79		174	80
FS38	3/8				3/8 x 4 Nipple	
		71	79		140	40
		100	114	2.8	194	60
		130	149		247	80
FS12	1/2				1/2 x 5 Nipple	
		140	147		214	40
		194	206	5.2	302	60
		247	259		390	80
FS34	3/4				3/4 x 6 Nipple	
		242	285		371	40
		340	395	9.2	517	60
		432	523		697	80

The standard cubic feet per minute (SCFM) that the flow control valves will pass exhaust to atmosphere is compared on the chart to the SCFM of air that will flow through a similar size and length of standard schedule 40 pipe.

SERIES J VALVES



SERIES J VALVES

ANGLE & IN-LINE FLOW CONTROL, NEEDLE & CHECK VALVES

JAQ ANGLE FLOW CONTROL WITH SERIES "AQ" TUBE CONNECTIONS

PART NUMBER	TUBE O.D.	PIPE	A	B	C	D	E
JAQ-5/32X2	5/32	1/8 NPT	1.73	1.38	0.75	0.63	9/16
JAQ-4X2	1/4	1/8 NPT	1.73	1.51	0.75	0.63	9/16
JAQ-4X4	1/4	1/4 NPT	2.11	1.62	1.04	0.75	11/16
JAQ-6X4	3/8	1/4 NPT	2.11	1.59	1.04	0.75	11/16
JAQ-6X6	3/8	3/8 NPT	2.19	1.85	1.06	0.88	7/8
JAQ-8X8	1/2	3/8 NPT	2.75	1.98	1.43	1.125	1.0

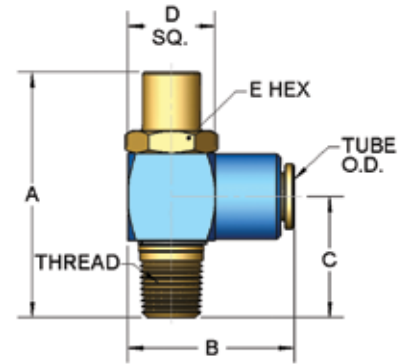

JPT ANGLE FLOW CONTROL WITH FEMALE PIPE THREADS

PART NUMBER	PT. 1	PT. 2	A	B	C	D	E
JPT-2X2	1/8 NPT	1/8 NPT	1.73	1.23	0.75	0.63	9/16
JPT-4X2	1/4 NPT	1/8 NPT	1.73	1.43	0.69	0.75	9/16
JPT-4X4	1/4 NPT	1/4 NPT	2.10	1.43	1.03	0.75	11/16
JPT-6X4	3/8 NPT	1/4 NPT	2.10	1.48	0.97	0.88	11/16
JPT-6X6	3/8 NPT	3/8 NPT	2.19	1.66	1.06	0.88	7/8
JPT-6X8	3/8 NPT	1/2 NPT	2.74	1.85	1.43	1.13	1.0
JPT-8X8	1/2 NPT	1/2 NPT	2.75	2.01	1.43	1.13	1.0

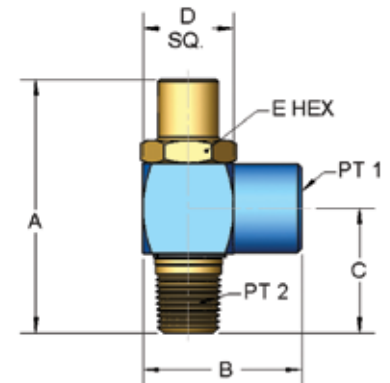

JC IN-LINE CHECK VALVE

BRASS BODY	NICKEL PLATED	PIPE SIZE NPTF	A	B	ORIFICE	Cv FACTOR
JC1	JC1N	1/8	1.468	0.562	0.206	0.64
JC2	JC2N	1/4	1.937	0.687	0.281	1.35
JC3	JC3N	3/8	2.312	0.875	0.421	3.22
JC4	JC4N	1/2	3.250	1.187	0.515	4.96
	JC6N	3/4	4.000	1.750	0.718	9.00
	JC8N	1	4.000	1.750	0.718	9.20



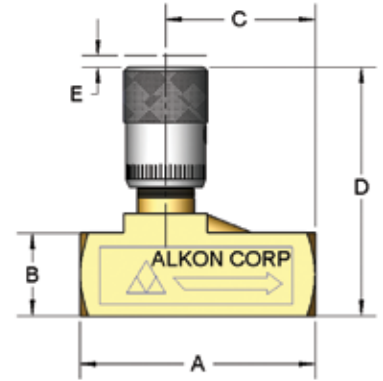

JF FLOW CONTROL VALVE

MODEL NO.			VALVE DIMENSIONS (INCHES)							ORIFICE ON		Cv FACTOR		
BRASS BODY	NICKEL PLATED	PIPE SIZE NPTF	A	B	C	D	E	F	G HEX SIZE	CHECK	NEEDLE	CHECK	NEEDLE FULL OPEN	APPROX. WEIGHT
JF1	JF1N	1/8	1.468	0.562	0.913	1.803	0.250	0.687	3/32	0.602	0.125	0.60	0.30	0.19
JF2	JF2N	1/4	1.937	0.687	1.232	2.000	0.250	0.687	3/32	0.281	0.187	1.30	0.60	0.28
JF3	JF3N	3/8	2.312	0.875	1.545	2.531	0.300	0.937	3/32	0.421	0.250	2.85	1.08	0.54
JF4	JF4N	1/2	3.250	1.187	2.117	3.218	0.375	1.250	3/32	0.515	0.375	4.96	1.75	1.75
	JF6N	3/4	4.000	1.750	2.625	3.906	0.375	1.250	3/32	0.718	0.500	9.00	3.20	2.32
	JF8N	1	4.000	1.750	2.635	3.906	0.375	1.250	3/32	0.718	0.500	9.20	3.20	2.20

JN IN-LINE NEEDLE VALVE

MODEL NO.			VALVE DIMENSIONS (inches)							Cv FACTOR	
BRASS BODY	NICKEL PLATED	PIPE SIZE NPTF	A	B	C	D	E	F	G HEX SIZE	ORIFICE	NEEDLE FULL OPEN
JN1	JN1N	1/8	1.468	0.562	0.913	1.803	0.250	0.687	3/32	0.125	0.30
JN2	JN2N	1/4	1.937	0.687	1.232	2.000	0.250	0.687	3/32	0.187	0.60
JN3	JN3N	3/8	2.312	0.875	1.545	2.531	0.300	0.937	3/32	0.250	1.08
JN4	JN4N	1/2	3.250	1.187	2.117	3.218	0.375	1.250	3/32	0.375	1.75
	JN6N	3/4	4.000	1.750	2.625	3.906	0.375	1.250	3/32	0.500	3.20
	JN8N	1	4.000	1.750	2.635	3.906	0.375	1.250	3/32	0.500	3.20



OMNI SERIES VALVES

OMNI 150 / 250 / 375

Today's industrial fluid power operations demand faster, more reliable power and control air valve systems. Alkon's OMNI Series valves meet these needs . . .

- ▶ **A Broad Range of Applications** makes the OMNI Series best suited for the widest variety of applications – automation and machine tool control, packaging machinery, robotics clamping, fixtures, cylinder controls, and most other pneumatic devices.
- ▶ **Reaction Time** is fast and reliable, and will speed your production capability. For example, it takes less than 16 milliseconds to shift the valve spool.
- ▶ **Superior Performance** is guaranteed. OMNI Series valves are the fastest, lightest, most compact high-flowing valve packages in the industry. On the basis of performance, OMNI valves deliver more production per dollar spent.
- ▶ **Flexibility** is an outstanding feature of all OMNI Series valves. Air pilot or solenoid operated, base or manifold mounted, horizontal or vertical stacking or in-line mounting, OMNI Series valves can be configured to your specific production or maintenance requirements.
- ▶ **Stacking Feature** is another OMNI Series advantage. OMNI series valves can be assembled into a variety of stacking arrangements to reduce piping requirements and increase mounting options. These stacks offer high-flow performance in compact, space saving packages. Stacking models have been designed to reduce downtime and quick and easy valve add-ons, removals or other changes.

OMNI Series valves are specifically engineered to withstand harsh factory environments. OMNI valves are precision-machined, lightweight, compact and corrosion resistant. They're simple and easy to maintain, designed for reliable performance and minimum downtime.



DESIGN FEATURES:

- Patented Teflon loaded Viton "Thin Lip Seal"
- Minimum breakout friction
- Anodized extruded aluminum
- Compact size
- 2 and 3 position, 3 and 4-way
- Highest flow in industry
- Many standard body styles
- 50 standard primary operators
- Proven performer in both lubricated and dry systems
- Adaptable for vacuum and low pressures
- Operates on standard filtration
- Variety of mounting options
- Simple to maintain

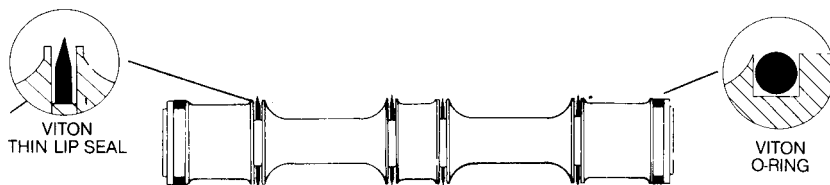

PATENTED "THIN LIP" SEAL & SPOOL FEATURES:

- Teflon loaded seals provide millions of trouble-free cycles
- Unique wiping action eliminates contaminant build-up in bore
- Reduces spool hang-up due to compressor or oil varnishing

HOW IT WORKS

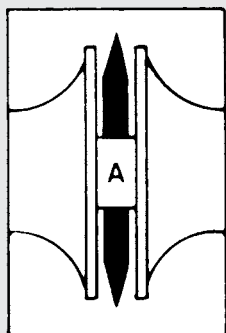

A. "Relaxed" no pressure on either side of seal.

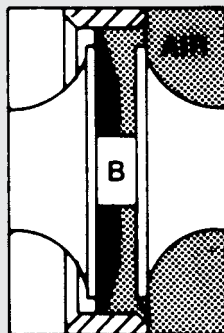

B. Pressure from right moves seal to left, expanding it against bore to sealed position.

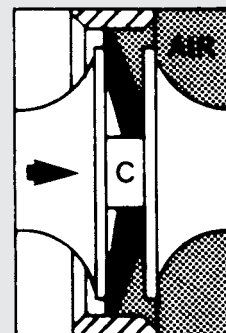









C. Force applied to left shifts spool... nominal sealing friction causes lip to flex like a diaphragm. Flexing action reduces breakdown friction. This spool can react quickly with very low force requirement.

ENGINEERING DATA FOR ALL OMNI VALVES

AVAILABILITY

	2-WAY	3-WAY	4-WAY	IN-LINE	STACKING	COMMON WIRE WAY	BASE MOUNTING	EXPLOS. PROOF
150	Plug 3-Way	✓	✓	✓	✓			
250	Plug 3-Way	✓	✓	✓	✓	✓	✓	✓
375	Plug 3-Way	✓	✓	✓	✓	✓	✓	✓

OPERATORS

								
150	✓	✓	✓					
250	✓	✓	✓					
375	✓	✓	✓	✓	✓	✓	✓	✓

OPERATOR REPLACEMENT

EXAMPLE: 375-37 120/60

- For air piloted valves, manual valves, and mechanically operated valves, furnish valve series and operator number only.
- For solenoid operators, specify voltage as well.

ENGINEERING DATA

	OMNI 150	OMNI 250	OMNI 375
Media	Air and inert gasses	Air and inert gasses	Air and inert gasses
Maximum Operating Pressure	150 PSI	150 PSI	150 PSI
Min. Pilot Pressure Solenoid/Solenoid	20 PSI	15 PSI	15 PSI
Min. Pilot Pressure Solenoid/Spring	45 PSI	40 PSI	45 PSI
Min. Pilot Pressure Air/Spring	45 PSI	40 PSI	40 PSI
Min. Pilot Pressure Air/Air	20 PSI	15 PSI	15 PSI
Vacuum To Below Min. Pilot	Available	Available	Available
Flow Rate @ 80 PSI (SCFM)	28	56	108
Max. Temperature	185°F	185°F	185°F
For Other Temperatures	Consult Factory	Consult Factory	Consult Factory

Pre-lubricated at factory to operate on lubricated or non-lubricated systems.

Cv FLOW

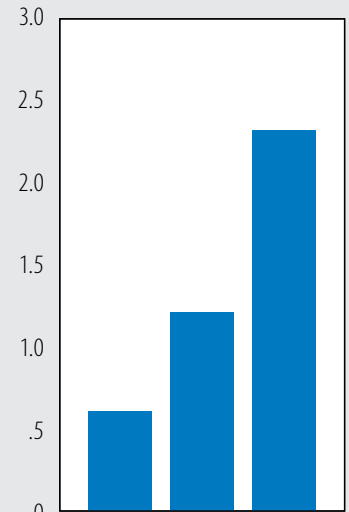

150 = .6CV = 28 SCFM
 250 = 1.2CV = 56 SCFM
 375 = 2.3CV = 108 SCFM

1 SCFM @ 80 PSIG = .073 dm³/s

LUBRICATION

All Alkon packed spool valves are pre-lubricated and will operate dry (with no additional lubrication), however a lubricated system will greatly extend the service life of any valve. Optional lubricants for special services are available.

The following oils are popular, easily obtainable fluids that are recommended for use with Alkon packed spool valves: Gulf Harmony 47, Mobil DTE Medium, Shell Tellus 29, Texaco Rondo B, Sohivis 47, Molubaloy, and Sunnis 921. Many other fluids are acceptable lubricants providing they do not contain detergents that will attack Buna N or Viton seals.

OMNI SERIES VALVES

ENGINEERING DATA FOR ALL OMNI VALVES *(Continued)*

SOLENOID SPECIFICATIONS

STANDARD VOLTAGES	OMNI 150		OMNI 250		OMNI 375	
	CURRENT (AMPS)		CURRENT (AMPS)		CURRENT (AMPS)	
	IN RUSH	HOLDING	IN RUSH	HOLDING	IN RUSH	HOLDING
110/50Hz	.09	.04	.13	.08	.13	.08
120/60Hz	.07	.03	.11	.07	.13	.08
215/50Hz			.06	.04	.13	.08
240/60Hz			.06	.03	.13	.08
24/60Hz			.6	.3	.13	.08
12VDC	.24	.24	.6 DIN=.87	.6 DIN=.87	.6 DIN=.87	.6 DIN=.87
24/VDC	.12	.12	.29 DIN=.43	.29 DIN=.43	.29 DIN=.43	.29 DIN=.43
120VDC			.05	.05	.13	.08

- Other AC and DC Voltages Available Upon Request
- Explosion Proof Solenoids Available on Some Models
- All Solenoids Designed to Meet or Exceed U.L. & CSA Requirements

SOLENOID HOUSING CLASSIFICATION

Conduit & Grommet Housings with Molded Coils Meet:

- NEMA 1 General Purpose = Indoors
- NEMA 2 Dripproof = Indoors
- NEMA 3 Driptight = Indoors
- NEMA 4* Watertight & Dusttight = Indoors & Outdoors
- NEMA 6* Submersible, Watertight, Dusttight & Sleet-Ice Resistant = Indoors & Outdoors

**Specify "Potted Coil Option to meet NEMA 4 & 6"*

Explosion Proof Housings Meet:

- NEMA 7C, 7D & CSA
- Class I = Groups C & D = Explosion Proof
- NEMA 8C, 8D & CSA
- Class I = Groups C & D = Explosion Proof
- NEMA 9E, 9F, 9G & CSA
- Class II = Groups E, F & G = Explosion Proof

How the Sleeve & Plunger Solenoid Air Pilot Assembly Works

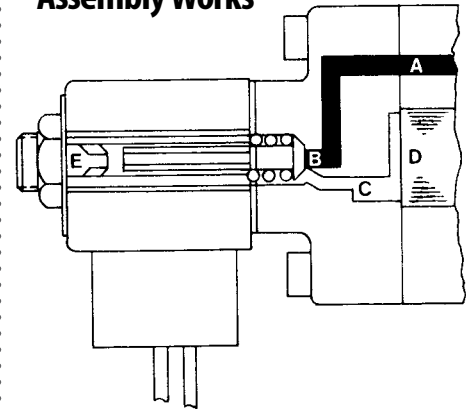

This diagram shows how this assembly works. Pilot air for the solenoid pilot is supplied from main line air through internal valve passage "A." With the solenoid in the de-energized position, the spring-loaded plunger seals against the air inlet "B." When the solenoid is energized, the plunger moves back and its top seat seals against the exhaust outlet "E." The top seat of the plunger is spring compensated against wear to assure complete, lifetime sealing. When the plunger moves off inlet port "B" the pilot air passes through outlet "C" to act on the end of the spool "D" causing the spool to shift. When the solenoid is de-energized, the plunger returns back to its starting position, the pilot air exhausts out of the spool chamber through inlet "C", past the plunger and out through outlet "E" to atmosphere.



REPLACEMENT PARTS

SPOOL REPLACEMENT

OPERATOR #	OMNI 150		OMNI 250			OMNI 375		
	3-WAY 2 POS.	4-WAY 2 POS.	3-WAY 2 POS.	4-WAY 2 POS.	4-WAY 3 POS.	3-WAY 2 POS.	4-WAY 2 POS.	4-WAY 3 POS.
06	N/A	N/A						
08	N/A	N/A	N/A	N/A	N/A	90A20095	90A20106	N/A
43	N/A	N/A						
09	N/A	N/A	N/A	N/A	N/A	90A20078	90A20075	N/A
10	N/A	N/A	N/A	N/A	N/A	90A20078	90A20075	N/A
15, 19	N/A	N/A	N/A	N/A	N/A	90A20112	90A20113	N/A
15T, 19T	N/A	N/A	N/A	N/A	N/A	N/A	N/A	B90A20185 P90A20186 E90A20187
27, 30 31, 32	N/A	N/A	N/A	N/A	N/A	90A20201	90A20127	N/A
ALL OTHERS	90A20290	90A20289	90A20325	90A20225 ALUMINUM 90A20226	B90A20230 P90A20231 E90A20232	90A20078	90A20075 ALUMINUM 90A20132	B90A20175 E90A20176 P90A20177

COIL/SOLENOID REPLACEMENT

OPERATOR #	OMNI 150		OMNI 250		OMNI 375	
	COIL	SOL	COIL	SOL	COIL	SOL
37 = 68 AC/DC	26A01056 110/50 26A01057 24/VDC 26A01058 12VDC	09A01064				
33 = 67 AC/DC	26A01056 110/50 26A01057 24VDC 26A01058 12VDC	09A01065				
60 AC DC	26A01072 SPECIFY VOLTAGE	09A01065				
61 AC DC	26A01072 SPECIFY VOLTAGE	09A01064				
33-37-38 64-65			26A01017	09A01001	26A01017	09A01001
42-66			26A01043	09A01039	26A01043	09A01039
60-61 62-63			26A01033	09A01023	26A01033	09A01023
67-68 82-86			26A01039	09A01038	26A01039	09A01038

OMNI SERIES VALVES

OMNI 150 SERIES VALVES

Flow Rating: .6 CV (2.04 dm³/s)

HOW TO ORDER OMNI 150 SERIES VALVES

E	150	02	_____	011	37	L	1																
Use When Ordering Metric Ports Only	Series (150)	Operator "B" (See Listing)	Operator Suffix (Optional)	Bodies	Operator "A" (See Listing)	Operator Suffix (Optional)	Voltages																
				<table border="1"> <thead> <tr> <th>First Digit Center Position</th> <th>Second Digit Port Size</th> <th>Third Digit Body Style/Type</th> </tr> </thead> <tbody> <tr> <td>0 = None</td> <td>1 = 1/8 NPT</td> <td>1 = In-line, 4-Way</td> </tr> <tr> <td></td> <td></td> <td>3 = Stacking, 4-Way</td> </tr> <tr> <td></td> <td></td> <td>7 = In-line, 3-Way</td> </tr> </tbody> </table>	First Digit Center Position	Second Digit Port Size	Third Digit Body Style/Type	0 = None	1 = 1/8 NPT	1 = In-line, 4-Way			3 = Stacking, 4-Way			7 = In-line, 3-Way			<table border="1"> <tbody> <tr> <td>1 = 120/60 AC*</td> </tr> <tr> <td>2 = 12 VDC*</td> </tr> <tr> <td>3 = 24/60 AC*</td> </tr> <tr> <td>4 = 24 VDC*</td> </tr> </tbody> </table>	1 = 120/60 AC*	2 = 12 VDC*	3 = 24/60 AC*	4 = 24 VDC*
First Digit Center Position	Second Digit Port Size	Third Digit Body Style/Type																					
0 = None	1 = 1/8 NPT	1 = In-line, 4-Way																					
		3 = Stacking, 4-Way																					
		7 = In-line, 3-Way																					
1 = 120/60 AC*																							
2 = 12 VDC*																							
3 = 24/60 AC*																							
4 = 24 VDC*																							
				<p>NOTE: In-line 3-Way bodies are field convertible to normally open or normally closed.</p>			<p>*Denotes standard voltages – others available on request.</p>																

OPERATOR SUFFIX - OPTIONAL

Letter Code	Description	Availability
L	Lighted Connector	68
R	Red, HD Spring	02
Y	.8 Watt Sol., DIN	68 (DC Only)

Additional operators available, consult factory

OPERATOR:

02	Spring Return
03	Air Pilot
61	Solenoid with lead wires and manual override
68	Solenoid with DIN connector and manual override

ORDERING PROCEDURE FOR OMNI 150 SERIES:

- 1. Series:** Identifies valve series
- 2. Operator:** B - secondary - returns spool
Operator suffix if applicable
- 3. Body:** The body style selects type of mounting and port sizes
- 4. Operator:** A - primary operator
Operator suffix if applicable
- 5. Volts:** Specify dash number

VALVE STACK ORDERING PROCEDURE:

- All 150 Series valve stacks are assembled with tie rods at the factory at no additional charge.
- To order, first list the model and quantity of each valve required. Second, specify the size of end plate assembly required (1/4 ports).
- Consult the factory for other options.



OMNI 150 SERIES VALVES

OPERATOR	PIPE SIZE	MODEL #	SCHEMATIC
Air Pilot	M5	150-02-031-03	
Spring Return	1/8	150-02-011-03	
Double Air	M5	150-03-031-03	
Pilot	1/8	150-03-011-03	
OPERATOR	PIPE SIZE	MODEL #	SCHEMATIC
Double Solenoid with Manual	M5	150-68-031-68	
Override	1/8	150-68-011-68	



4-Way/Air Pilot



4-Way/Solenoid

OPERATORS

02-Operator Spring Return End Cap
(01-Operator dimensions are the same as 02)

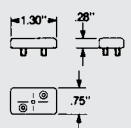

03-Operator Air Pilot End Cap

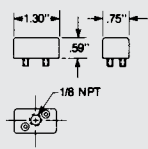

Lead Wire Coil
 60 Operator — Solenoid
 61 Operator — Solenoid with Manual Override

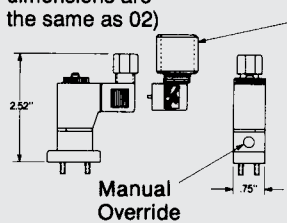
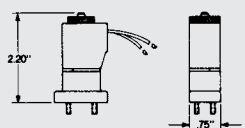

33 Operator — 1/2 Conduit
37 Operator — 1/2 Conduit With Manual Override

INLINE BODY

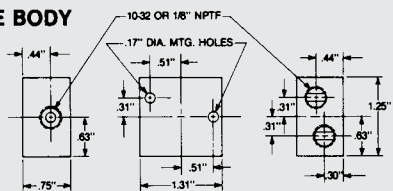

Note: 3-Way inline bodies are field convertible NC or NO.

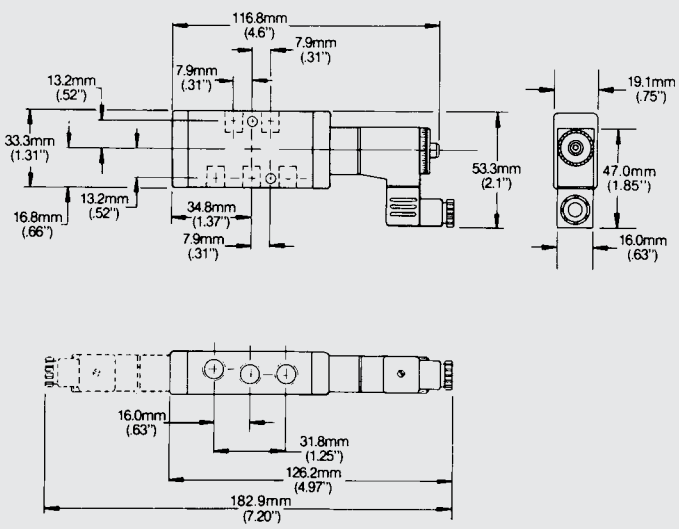
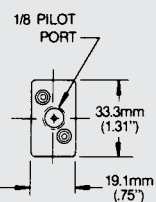
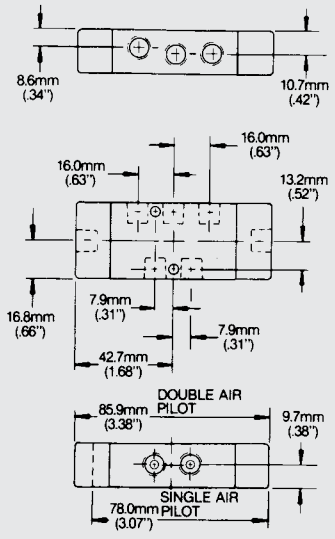

OMNI SERIES VALVES

OMNI 150 SERIES VALVES

NEW "FLIP-OUT" DESIGN

The Alkon "Flip-Out" design is a special OMNI valve feature which makes valve changes, add-ons or removals quick and easy. Notched valve bodies and end plates permit "Flip-Out" valve replacement or stack rearrangement in seconds. Simply loosen top tie-rod, remove and lift out valve.

END PLATE ASSEMBLY FOR STACKING 4-WAY		
150-H14	1/4	Horizontal

Note: End Plate Assembly furnished with 2 End Plates, 3 Tie Rods, All Nuts and O-Rings required.

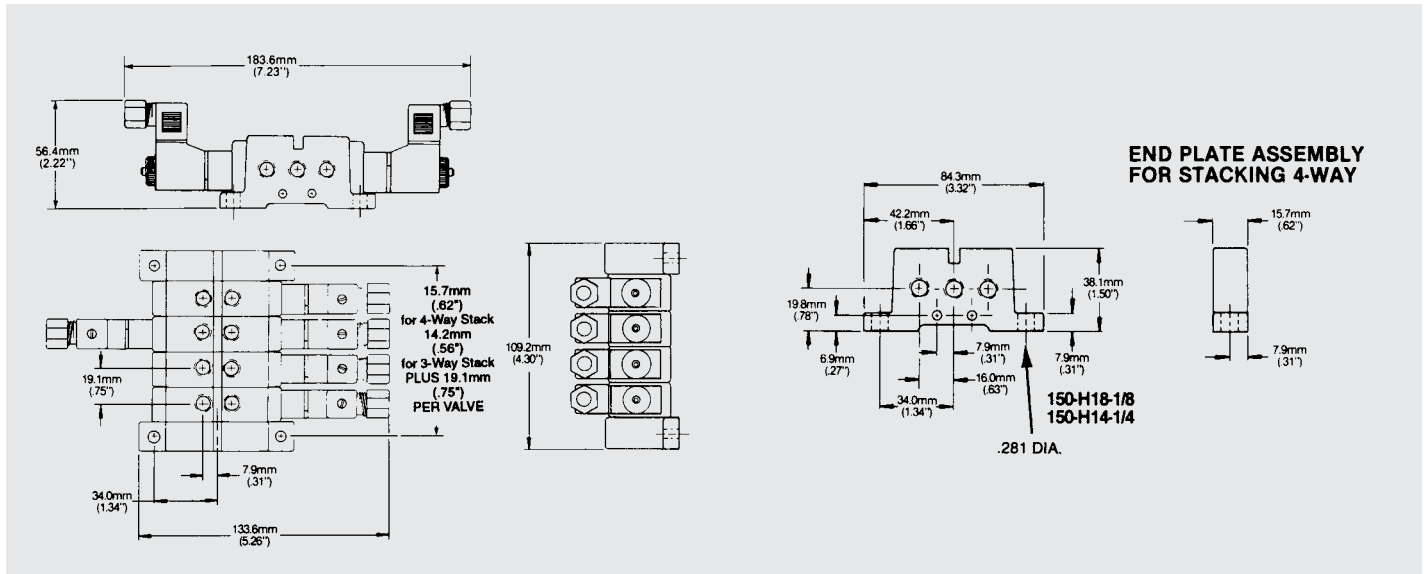

OMNI 250 SERIES VALVES

Flow Rating: 1.2 CV (4.09 dm³/s)

HOW TO ORDER OMNI 250 SERIES VALVES

E	250	02	_____	011			37	E	1
Use When Ordering Metric Ports Only	Series (250)	Operator "B" (See Listing)	Operator Suffix (Optional)	Bodies			Operator "A" (See Listing)	Operator Suffix (Optional)	Voltages
				First Digit Center Position	Second Digit Port Size	Third Digit Body Style/Type			
				0 = None	0 = 1/4 NPT	0 = Body Blank, 4-Way			
				B = Blocked	1 = 1/8 NPT	1 = In-line, 4-Way			
				E = Exhausted		2 = Stacking, 4-Way Ind'l Exhaust			
						3 = Stacking, 4-Way			
						4 = Base Mounted			
						7 = In-line, 3-Way			
						9 = Stacking, 4-Way Common Wireway Mount			
							1 = 120/60 AC*		
							2 = 12 VDC*		
							3 = 24/60 AC*		
							4 = 240/60 AC*		
							5 = 24 VDC*		

OPERATOR SUFFIX - OPTIONAL		
Letter Code	Description	Availability
H	Class H Coil, Viton Sleeve & Plunger	37
L	Lighted Connector	67, 68, 82
R	Red, HD Spring	02

OPERATOR NUMBER:	
02	Spring Return
03	Air Pilot
37	Solenoid with 1/2" conduit connection & manual override
42	Solenoid - explosion proof
68	Solenoid with DIN connector & manual override
82	Solenoid with DIN connector, locking manual override

Additional operators available, consult factory.

*Denotes standard voltages – others available on request.

ORDERING PROCEDURE FOR OMNI 250 SERIES:

- Series:** Identifies valve series
- Operator:** B - secondary - returns spool
Operator suffix if applicable
- Body:** The body style selects type of mounting & port sizes
- Operator:** A - primary operator
Operator suffix if applicable
- Volts:** Specify dash number
- For stacking valves refer to page 37 & 38

Note: Air pilot or solenoid operators may be used with either 2 position or 3 position body styles



OMNI SERIES VALVES

OMNI 250 SERIES VALVES

AIR PILOT OPERATED

The OMNI Series 3-Way and 4-Way valves can be air pilot operated with three types of assemblies:

1. **DOUBLE AIR PILOT (NO VALVE SPOOL SPRING).** The valve spool is shifted by a momentary air pilot signal to either of the "A" or "B" Pilots.
2. **SINGLE AIR PILOT, SPRING RETURN.** The valve spool is maintained in the normal rest position in the "B" end. A maintained air pressure signal at the "A" end greater than the spring force will shift the valve spool.
3. **DOUBLE AIR PILOT, SPRING OFFSET.** The valve spool is maintained in the normal rest position in the "B" end. A maintained air pressure signal at the "A" end greater than the spring force will shift the valve spool, providing no air pressure signal is on the "B" end. By controlling the pressure differential between "A" and "B" a variety of applications are available.

DESCRIPTION	BASIC VALVE MODEL NUMBERS		SCHEMATICS
	PIPE SIZE	NUMBER	
Air Pilot Spring Return	1/8 NPTF	250-02-011-03	
	1/4 NPTF	250-02-001-03	
Double Air Pilot	1/8 NPTF	250-03-011-03	
	1/4 NPTF	250-03-001-03	
Double Air Pilot Spring Offset	1/8 NPTF	250-04-011-03	
	1/4 NPTF	250-04-001-03	



3-Way/Air Pilot



4-Way/Air Pilot

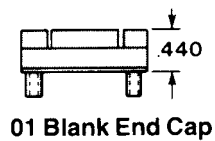

01 Blank End Cap

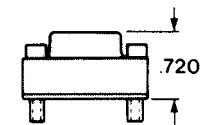

03 Air Pilot

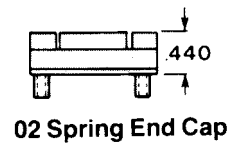

02 Spring End Cap

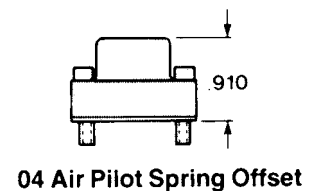

04 Air Pilot Spring Offset

Double Air Pilot

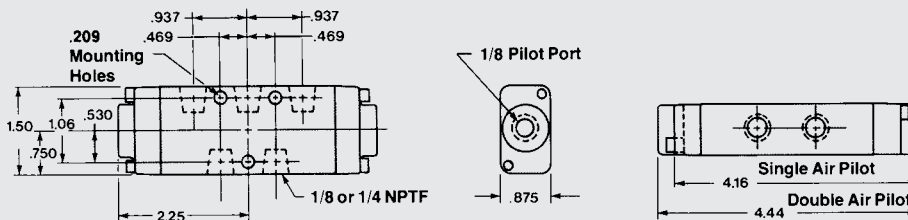

Note: For 3-Way body see page 35

03 Air Pilot

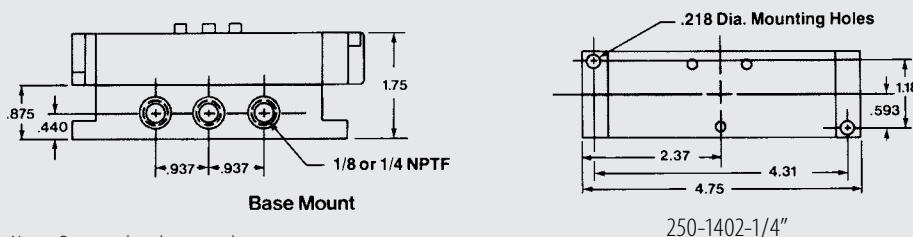

Note: Bases ordered separately

OMNI 250 SERIES VALVES

SOLENOID AIR PILOT OPERATED

The OMNI 250 3-Way and 4-Way Solenoid Air Pilot Operated Valves Offer these Special Electrical Features:

- Solenoid assembly so reliable it's guaranteed
- A variety of standard AC or DC voltage options
- Plug-in electrical connectors
- Explosion proof operators
- All coils molded epoxy
- Built to meet or exceed UL standards
- Intrinsically safe operators available
- Class H, hi-temp solenoids available

Single Solenoid Spring Return with Manual Override, Explosion Proof

BASIC VALVE MODEL NUMBERS	
PIPE SIZE	NUMBER
1/8 NPTF	250-02-011-42
1/4 NPTF	250-02-001-42

SCHEMATICS	

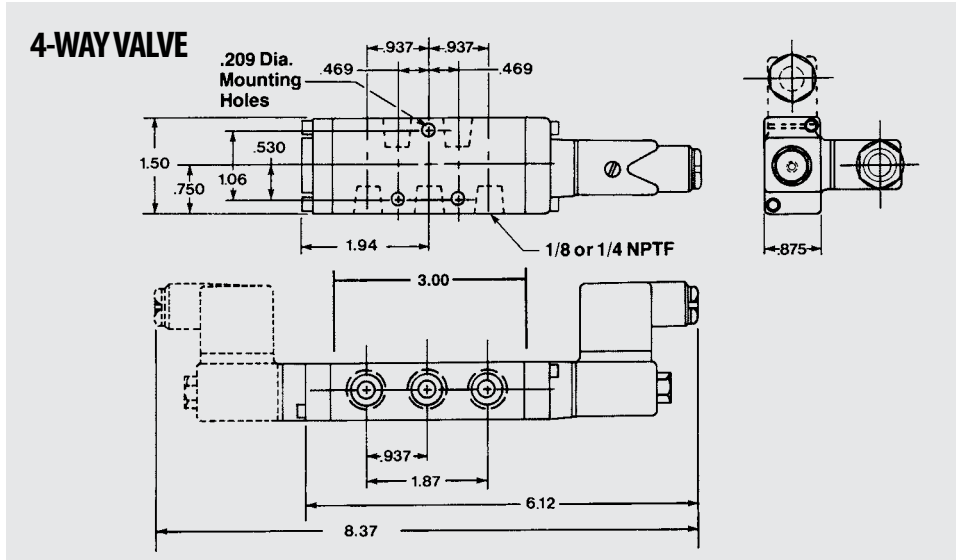

Double Solenoid Momentary Contact and Manual Override

BASIC VALVE MODEL NUMBERS	
PIPE SIZE	NUMBER
1/8 NPTF	250-37-011-37
1/4 NPTF	250-37-001-37

SCHEMATICS	

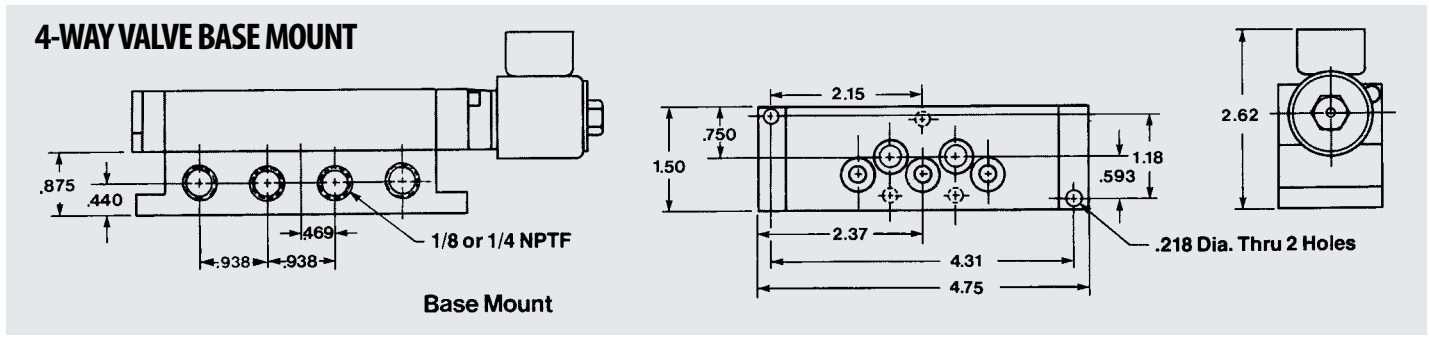
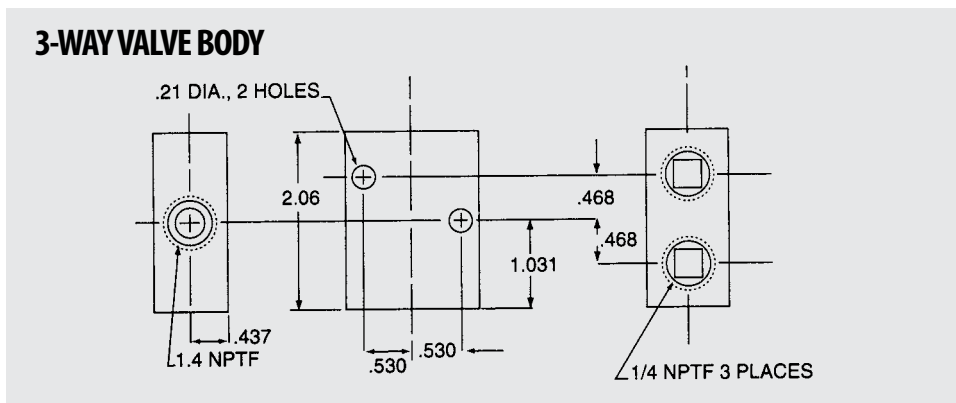

OMNI SERIES VALVES

OMNI 250 SERIES VALVES

SOLENOID AIR PILOT OPERATED

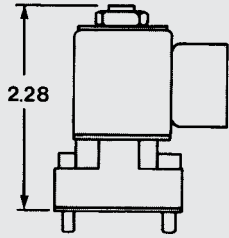

Conduit Connection

37 Solenoid with Non-Locking Manual Override

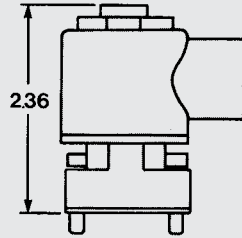

Explosion Proof

42 Explosion Proof Solenoid with Manual Override

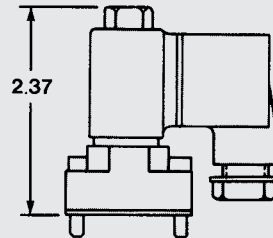

DIN Connector

68 Solenoid with Manual Override
82 Solenoid with Locking Manual Override

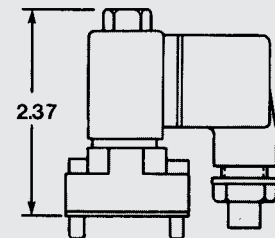

Common Wireway

68C Solenoid with Manual Override
82c Solenoid with Locking Manual Override

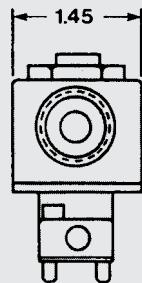

42 Non-Locking Override Push Type Shown With Explosion Proof



Locking Override Push and Turn Shown with DIN Connector

Note: 55 in.-lbs. nut torque



OMNI 250 SERIES VALVES

STACKING & COMMON WIREWAY ARRANGEMENTS

The OMNI 250 Series valves can be assembled into a variety of stacking arrangements which greatly reduce piping requirements and increase mounting options. These stacks offer high flow performance in compact, space saving packages which include:

- 4-Way, 5 ported stacks with common input and dual common exhaust or individual exhaust
- Available tapped 1/8 or 1/4 NPTF
- Horizontal or vertical mounting
- Available with common electrical wireway
- 2 and 3 position
- Dual pressure available via blocking disc #32A01010
- Common External Pilot available



Wireway Arrangement

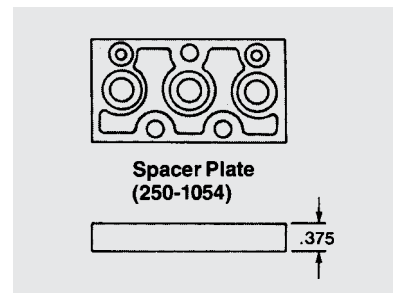

Ordering Information:

All 250 Series valve stacks are assembled with tie rods at the factory at no additional charge. To order, first list the quantity and model of each type of valve required, (see page 33). Second, determine the number of 3/8" wide spacers required between each valve. When 03, 04, 60Y, 61Y, 62Y, 63Y, 67, 68 and 82 operators are used, spacers are not required. When 09, 13, 15, 15Tm, 33m, 37, 38 and 50, 51, 52, 53, 60, 61, 64 and 65 operators are used, allow one spacer between each valve, but not between a valve and end plate. For 42 operators, use two spacers between each valve but not between a valve and end plate. For common electrical wireway, spacers are not required. Third, specify the type of end plate assembly required (horizontal or vertical mounting and 1/8 or 1/4 NPTF ports). Fourth, for common wireway stack, specify model enclosure. (See examples shown on right column of this page.)

Example:

- (2) 250 Series stack each consisting of:
 - (4) 250-02-013-37 120/60 valve
 - (3) 250-1054 spacer plate
 - (1) 250-1333 horizontal end plate assembly 1/8 NPTF

Example:

- (2) 250 Series stack each consisting of:
 - (4) 250-02-019-68C 120/60 valve
 - (1) 250-1334 spacer plate assembly
 - (1) 25-1131 Single solenoid enclosure

ORDER NUMBERS FOR COMMON WIREWAY NEMA 4 ENCLOSURE	
DESCRIPTION	MODEL
2 thru 4 single solenoid enclosure*	25-1131
2 thru 4 double solenoid enclosure*	25-1132
5 thru 6 single solenoid enclosure	25-1133
5 thru 6 double solenoid enclosure	25-1134
7 thru 10 single solenoid enclosure	25-1135
7 thru 10 double solenoid enclosure	25-1136
11 + valves	Consult factory

* When ordering a 2 valve stack, one extra spacer must be ordered - #45A01058. If any one valve in stack is double solenoid, you must order double solenoid enclosure.

ORDER NUMBERS FOR COMMON WIREWAY & STANDARD STACK END PLATE ASSEMBLIES	
DESCRIPTION	MODEL
Vertical mount assembly (1/4 NPTF ports)	250-1334
Horizontal mount assembly (1/4 NPTF ports)	250-1333
Spacer Plate	250-1054

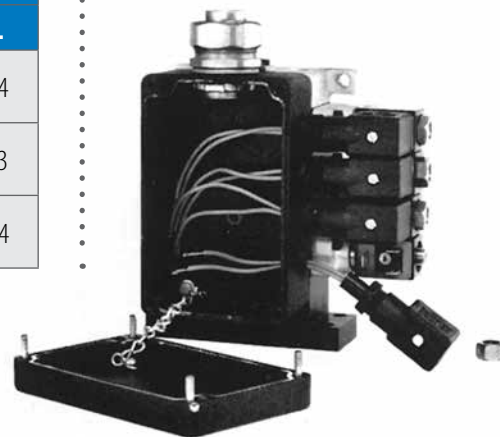

OMNI SERIES VALVES

OMNI 250 SERIES VALVES

STACKING ARRANGEMENTS

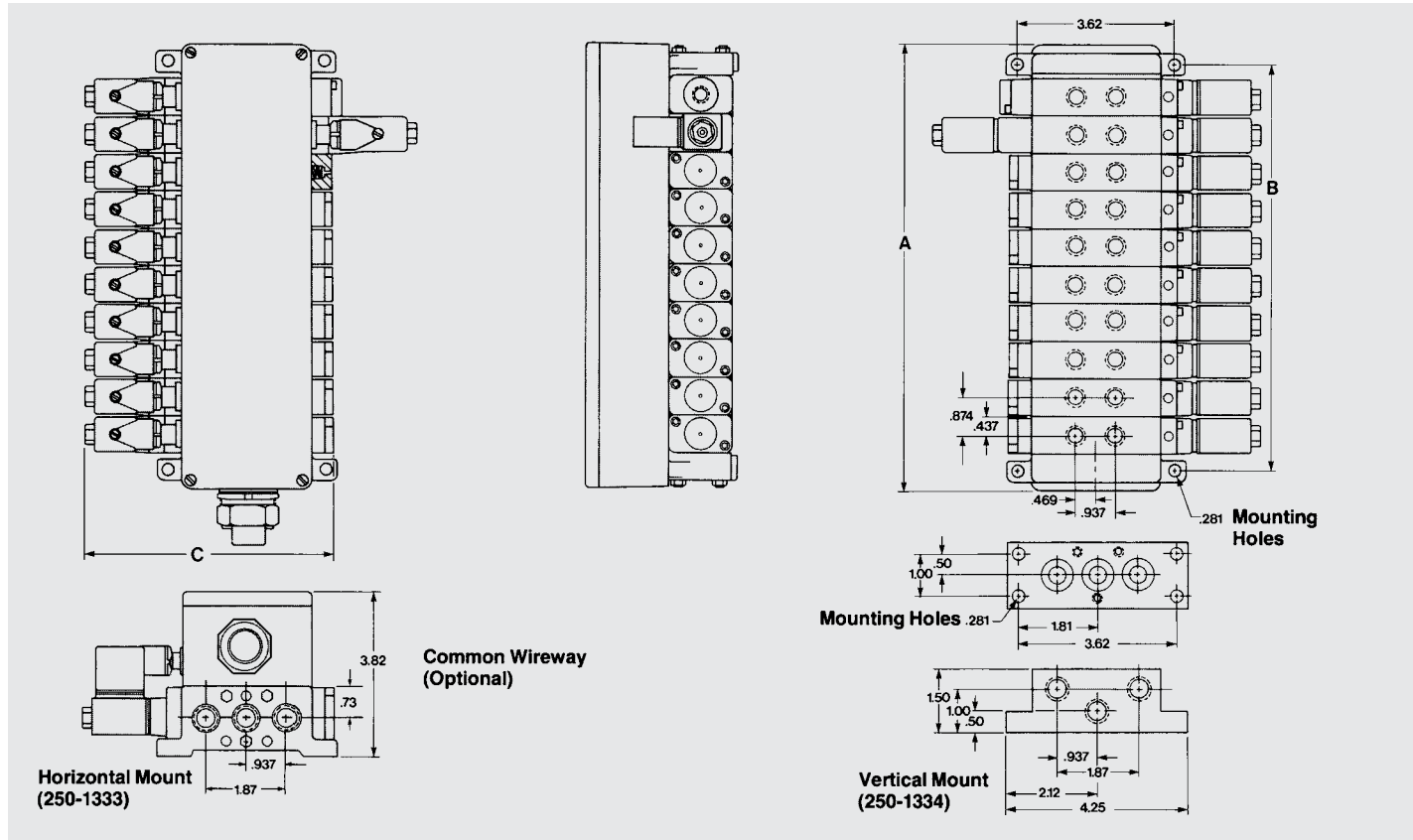

NO. VALVES	A	B	VALVE STYLE	C
2 or 3	5.00	3.38	2 Pos. Single Solenoid Spring Return	5.86
4	5.00	4.25		
5	7.00	5.13	2 Pos. Single Solenoid Air Return	6.07
6	7.00	6.00		
7	9.80	6.88	2 Pos. Double Solenoid	7.70
8	9.80	7.75		
9	9.80	8.63		
10	9.80	9.50		

Note: Horizontal end plates may be attached with either the mounting feet on the port side or the side opposite. Unless otherwise specified, all common wireway stacks have the mounting feet on the port side and all other stacks have the feet on the side opposite the ports. When ordering, if more than one model number valve is to be stacked, specify valve position by numbering valves from left to right while facing the "B end" operators. If a vertical mounting plate is used, number valves starting from vertical plate.

Example:

- 250 Stack Consisting of:
- (2) 250-02-003-03 air pilot
 - (1) 250-02-003-68 DIN connector
 - (1) 250-02-013-60Y grommet
 - (1) 250-02-003-03 air pilot
 - (1) 250-01-003-15 lever
 - (1) 250-02-013-37 conduit
 - (1) 250-02-003-42 ex. proof
 - (4) 250-1054 spacer plate
 - (1) 250-1333 end plate assembly

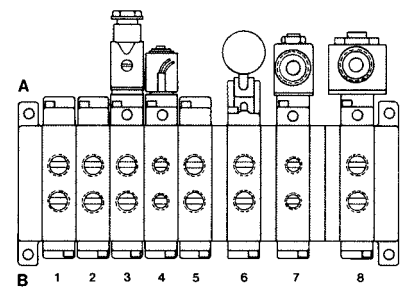

OMNI 250 SERIES VALVES

REPLACEMENT PARTS

Spool Replacement



3 Position "B"
90A20230

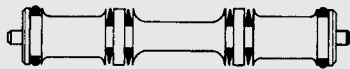

3 Position "P"
90A20231



3 Position "E"
90A20232

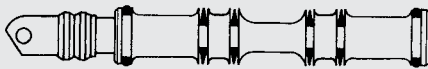

3 Position "B" Lever
90A20233



3 Position "P" Lever
90A20234



3 Position "E" Lever
90A20235



2 Position Palm Button
90A20227

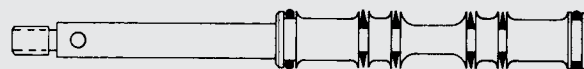

2 Position Panel MTD. Palm Button
90A20228



2 Position Lever
90A20229



2 Position
90A20225 - Aluminum Spool - Mechanical Operators
90A20226 - Plastic Spool - Solenoid and Air Operators

COIL REPLACEMENT

DESCRIPTION	MODEL
Coil with conduit housing, 7 watt, 33, 37, 38, 64, 65 operators	26A01017
Coil or Grommet Connection, 7 watt, 59, 60, 61 operators	26A01033
Coil with DIN connector, 8.5 watt, 67, 68, 82, 67C, 82C operators	26A01039
Coil with explosion proof housing, 7 watt, 42, 66 operators	26A01043

When ordering coil, give part number and voltage.
Standard voltages are: 120/60, 240/60, 6VDC, 24VDC. For other voltages consult factory.

Torque Settings for Coil Hold Down Nuts are:

- 20-25 in-lbs. for Canned type operators
- 20-25 in-lbs. for DIN operators
- 55 in-lbs. for operators 42

OMNI SERIES VALVES

OMNI 375 SERIES VALVES

Flow Rating: 2.3 CV (7.88 dm³/s)

HOW TO ORDER OMNI 375 SERIES VALVES

E	375	02	_____	011	67	L	1
Use When Ordering Metric Ports Only	Series (375)	Operator "B" (See Listing)	Operator Suffix (Optional)	Bodies	Operator "A" (See Listing)	Operator Suffix (Optional)	Voltages
				First Digit Center Position	Second Digit Port Size	Third Digit Body Style/Type	1 = 120/60 AC*
				0 = None	0 = 1/4 NPT	1 = In-line, 4-Way	2 = 12 VDC*
				B = Blocked	8 = 3/8 NPT	2 = Stacking, 4-Way Ind'l Exhaust	3 = 24/60 AC*
				E = Exhausted		3 = Stacking, 4-Way	4 = 240/60 AC*
				P = Pressurized		4 = Base Mounted	5 = 24 VDC*
				Additional threads available – consult factory.			*Denotes standard voltages – others available on request.
						7 = In-line, 3-Way	
						9 = Stacking, 4-Way Common Wireway Mount	

OPERATOR SUFFIX - OPTIONAL		
Letter Code	Description	Availability
F	Filtered & Potted Solenoid for NEMA 4 Solenoid	33, 37, 38, 64, 65
H	Class H Coil, Viton Sleeve & Plunger	33, 37, 38, 64, 65
L	Lighted Connector	67, 68, 82, 86
R	Red, HD Spring	02, 04
R	Red Palm Button	9 thru 12, 14, 43



ORDERING PROCEDURE FOR OMNI 375 SERIES:

- 1. Code:** E - Use when ordering metric ports only
- 2. Series:** Identifies valve series
- 3. Operator:** B - secondary - returns spool
Operator suffix if applicable
- 4. Body:** The OMNI 375 is a 2 or 3 position valve
The body style selects type of mounting & port sizes
(see page 49 for 3 position valves)
- 5. Operator:** A - primary operator
Operator suffix if applicable
- 6.** Specify voltages or any other special conditions
- 7.** For stacking valves, refer to pages 50 & 51
- 8.** For manifold valves, refer to pages 52 & 53

OMNI 375 SERIES VALVES

OPERATOR NUMBER:

01	Blank end cap
02	Spring Return
03	Air Pilot
04	Air Pilot - Spring offset
05	7/8" diameter knob push to operate
06	7/8" diameter knob detented, (must be used with 01 operator)
07	7/8" diameter knob, panel mounted, push to operate
08	7/8" diameter knob, panel mounted, detented, (must be used with 01 or 03 operator)
09	Palm button, push to operate
10	Panel Mount Palm button spring return
12	Palm button, panel mounted, push to operate
13	Lever, parallel, push to operate
14	Palm button, detented, push-pull to operate (must be used with 01 operator)
15	Lever, parallel, detented, push-pull to operate (must be used with 01 operator)
17	Lever, perpendicular, push to operate (must be used with 02 operator)
19	Lever, perpendicular, detented, push-pull to operate (must be used with 01 operator)
27	Plunger operator
30	Roller lever, actuation left (reference supply port-right) (use with 02 operator)
31	Roller lever, actuation right (reference supply port-right) (use with 02 operator)
32	Roller lever, 2-Way actuation (use with 02 operator)
33	Solenoid with 1/2" conduit ports
34	Foot pedal (must use with 02R operator)
37	Solenoid with 1/2" conduit connection and manual override
38	Solenoid with 1/2" conduit connection and locking manual override
39	Foot treadle, detented (must be used with 01 operator)
42	Solenoid - explosion proof, conduit connection, manual override
43	Panel mount palm button, push-pull to operate detented (must be used with 01 operator)
59	Solenoid with lead wires and locking manual override
60	Solenoid with lead wires
61	Solenoid with lead wires, manual override
65	Solenoid with 1/2" conduit connection, manual override, external pilot supply
67	Solenoid with DIN connector
68	Solenoid with DIN connector and manual override
70	Air pilot with shuttle - auxiliary port plugged
81	Air pilot with spool position indicator, manual override
82	Solenoid with DIN connector, locking manual override
83	Air pilot, manual actuator
86	Solenoid with DIN connector, manual override, external pilot supply



OMNI SERIES VALVES

OMNI 375 SERIES VALVES

3-WAY & 4-WAY SOLENOID AIR PILOT OPERATED

The OMNI 375 3-Way and 4-Way solenoid air pilot operated valves offer these special electronic features:

- Solenoid assembly so reliable it's guaranteed.
- Explosion proof operators.
- A variety of standard AC or DC voltage options.
- All coils molded epoxy – standard.
- Dual rated solenoids for 50/60 cycles.
- Build to meet or exceed UL standards.
- Plug in electrical connectors.
- Class H, hi-temp solenoid available.



3-Way

33 Operator

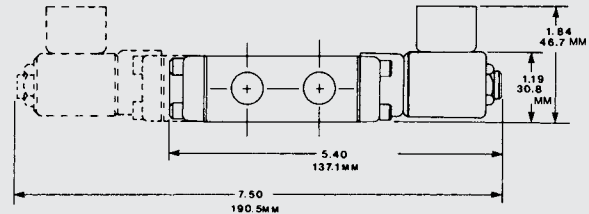
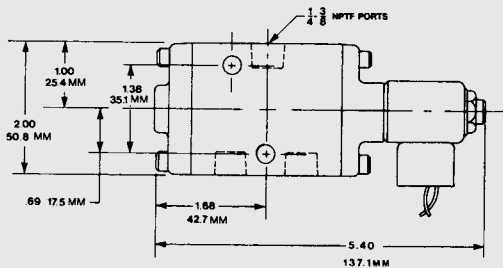

4-Way

33 Operator

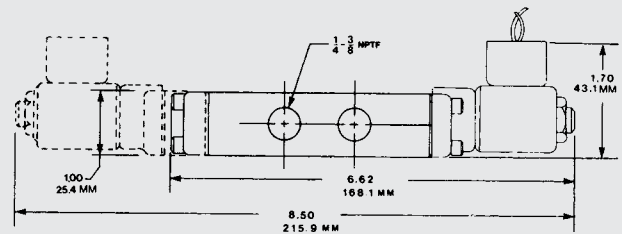
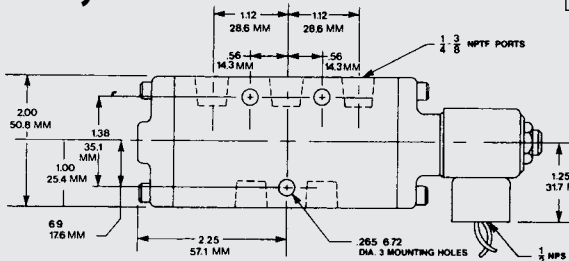

Base Mount

33 Operator

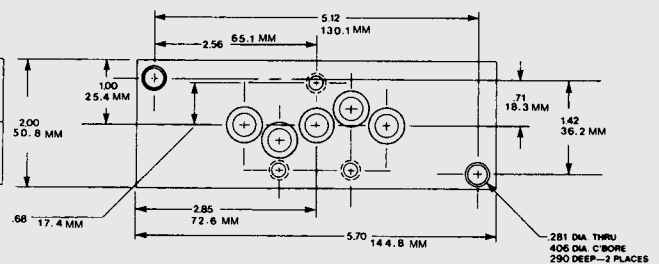
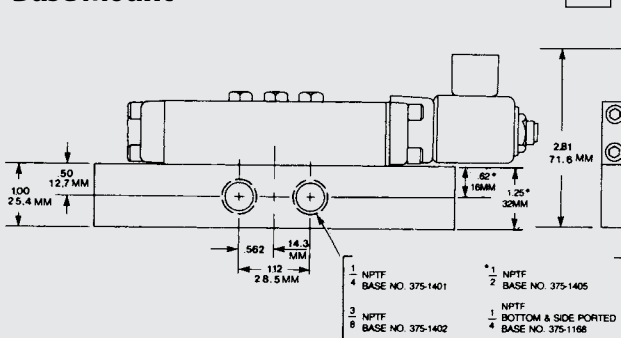

OMNI 375 SERIES VALVES

BASIC VALVE MODEL NUMBERS

DESCRIPTION	3-WAY			4-WAY		
	PIPE SIZE	NUMBER	SCHEMATICS	PIPE SIZE	NUMBER	SCHEMATICS
Double Solenoid Momentary Contact with Manual Override	1/4 NPTF	375-37-007-37		1/4 NPTF	375-37-001-37	
	3/8 NPTF	375-37-087-37		3/8 NPTF	375-37-081-37	
Single Solenoid Spring Return with Manual Override	1/4 NPTF	375-02-007-37		1/4 NPTF	375-02-001-37	
	3/8 NPTF	375-02-087-37		3/8 NPTF	375-02-081-37	

Optional Solenoid Operators

This series of 4-Way valves is available with base mounting which permits the removal or changing of a valve without disturbing the piping. The 374 Series valve is machined from extruded aluminum and available with 5 threaded ports in 1/4 or 3/8 NPTF. The valve body (004) has 5 unthreaded ports on the wide part of the valve which mate with the 5 ports on the top of the base. The body is supplied with 5 Viton O-rings and is assembled to the base.

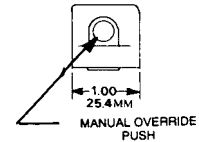

- 33 Solenoid Air Pilot Conduit Connection
- 37 Solenoid Air Pilot with Manual Override And Conduit Connection
- 38 Solenoid Air Pilot with Locking Manual Override

- 59 Solenoid Air Pilot with Lead Wires And Locking Manual Override
- 60 Solenoid Air Pilot with Lead Wires
- 61 Solenoid Air Pilot with Lead Wires and Manual Override

- 67 DIN Connector
- 68 DIN Connector with Manual Override
- 82 DIN Connector with Locking Manual Override
- 86 DIN Connector with Manual Override External Pilot Supply

- 67C DIN Connector
- 68C DIN Connector with Manual Override
- 82C DIN Connector with Locking Manual Override
- 86C DIN Connector with Manual Override External Pilot Supply

42 Explosion Proof Solenoid

DESCRIPTION	PIPE SIZE	NUMBER
Single solenoid, spring return valve, base mounted, valve only		375-02-004-37
Side Ported Base	1/4 NPTF	375-1401
	3/8 NPTF	375-1402
	1/2 NPTF	375-1405
Side & Bottom Ported Base	1/4 NPTF	375-1168

Note: Valves and bases must be ordered separately

Normally Closed/Normally Open Valves

Note: Unless otherwise specified, all 375 Series 3-Way solenoid valves are supplied as Normally Closed and the #3 port is the supply port. If a Normally Open valve is required, it must be specified and the #1 port must be piped as the supply port. EXAMPLE: N0375-02-007-33 120/60

All solenoid operators available in the following voltages: 120/60, 240/60, 6VDC, 12VDC, 24VDC. For other voltages, Class H or low watt coils, consult factory.

OMNI SERIES VALVES

OMNI 375 SERIES VALVES

3-WAY & 4-WAY AIR PILOT OPERATED

The OMNI 375 Series 3-Way and 4-Way Valves can be Air Pilot Operated with three types of assemblies:

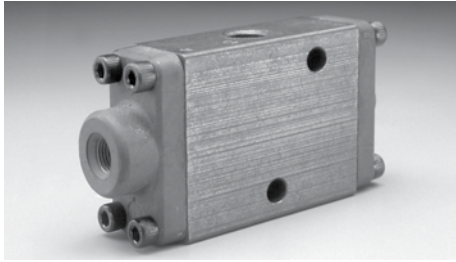

Single Air Pilot, Spring Return

The valve spool is maintained in the normal rest position by the spring in the "B" end. A maintained air pressure signal at the "A" end greater than the spring force will shift the valve spool.

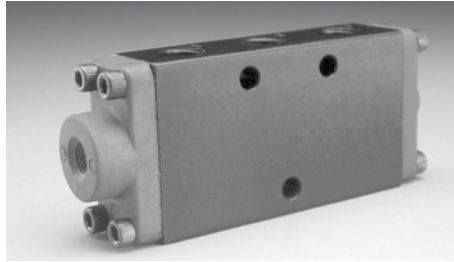

Double Air Pilot (No Valve Spool Spring)

The valve spool is shifted by a momentary air pilot signal to either of the "A" or "B" Pilots.

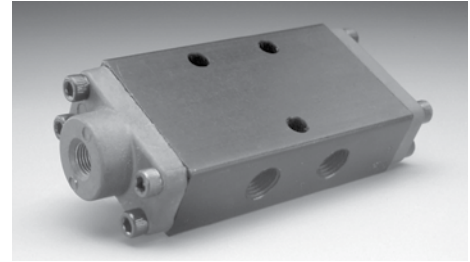

Double Air Pilot, Spring Offset

The valve spool is maintained in the normal rest position by a spring in the "B" end. A maintained air pressure signal at the "A" end greater than the spring force will shift the valve spool, providing no air pressure signal is on the "B" end. By controlling the pressure differential between "A" and "B," a variety of applications are possible.

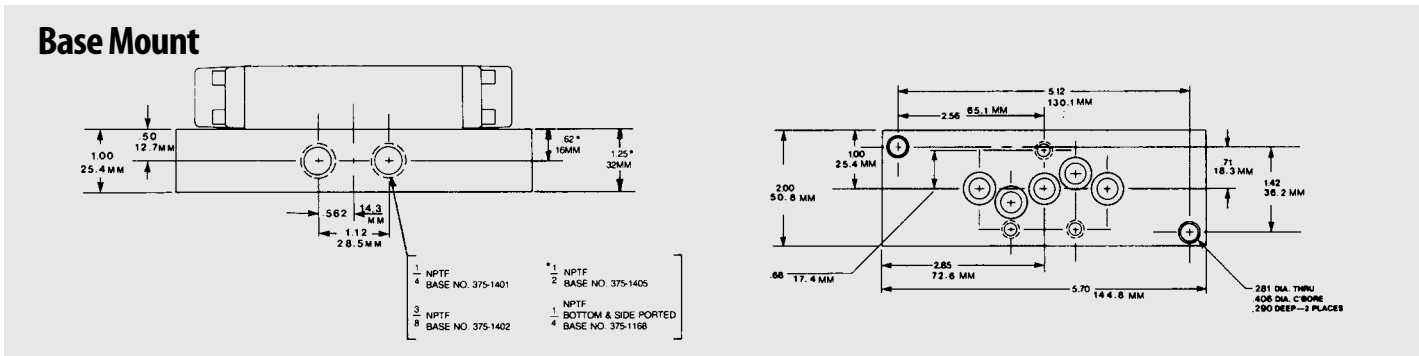
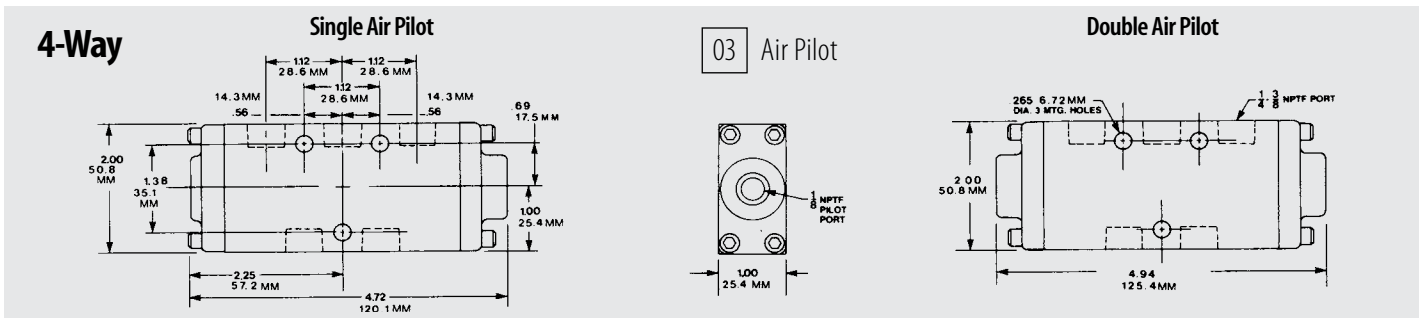
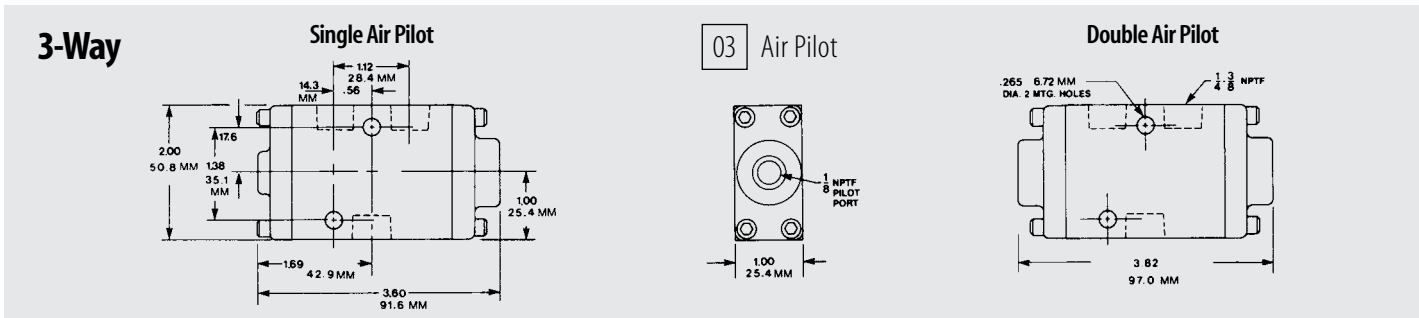

OMNI 375 SERIES VALVES

BASIC VALVE MODEL NUMBERS

DESCRIPTION	3-WAY			4-WAY		
	PIPE SIZE	NUMBER	SCHEMATICS	PIPE SIZE	NUMBER	SCHEMATICS
Single Air Pilot Spring Return	1/4 NPTF	375-02-007-03		1/4 NPTF	375-02-001-03	
	3/8 NPTF	375-02-087-03		3/8 NPTF	375-02-081-03	
Double Air Pilot	1/4 NPTF	375-03-007-03		1/4 NPTF	375-03-001-03	
	3/8 NPTF	375-03-087-03		3/8 NPTF	375-03-081-03	
Double Air Pilot Spring Biased	1/4 NPTF	375-04-007-03		1/4 NPTF	375-04-001-03	
	3/8 NPTF	375-04-087-03		3/8 NPTF	375-04-081-03	

This Series of 4-Way valves is available with base mounting which permits the removal or changing of a valve without disturbing the piping. The 375 Series base is machined from extruded aluminum and available with 5 threaded ports in 1/4, 3/8 or 1/2 NPTF. The valve body (004) has 5 unthreaded ports on the wide part of the valve which mate with the 5 ports on the top of the base. The body is supplied with 5 Viton O-rings and is assembled to the base.

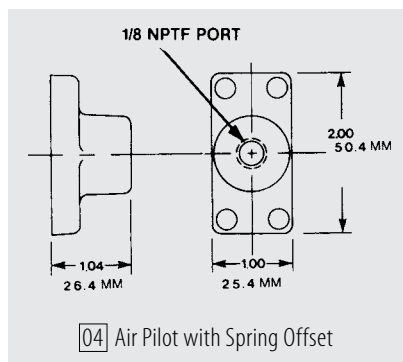
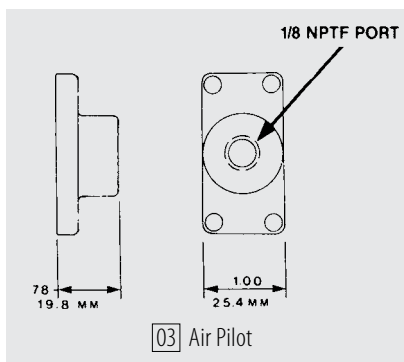
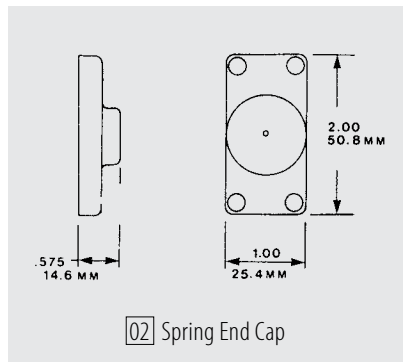
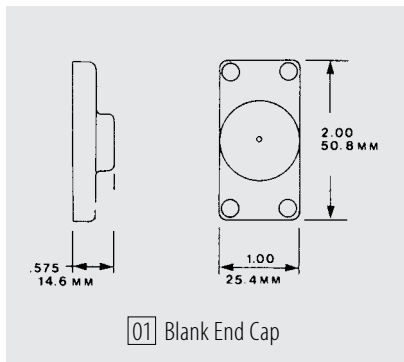

DESCRIPTION	PIPE SIZE	NUMBER
Air pilot, spring return valve, base mounted, valve only		375-02-004-03
Side Ported Base	1/4 NPTF	375-1401
	3/8 NPTF	375-1402
	1/2 NPTF	375-1405
Side & Bottom Ported Base	1/4 NPTF	375-1168

Note: Valve and bases must be ordered separately.

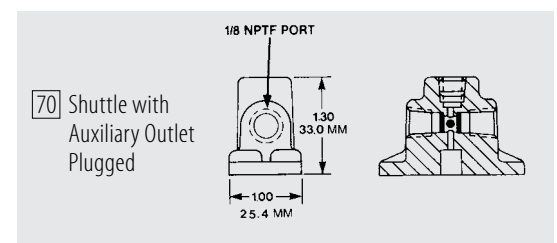
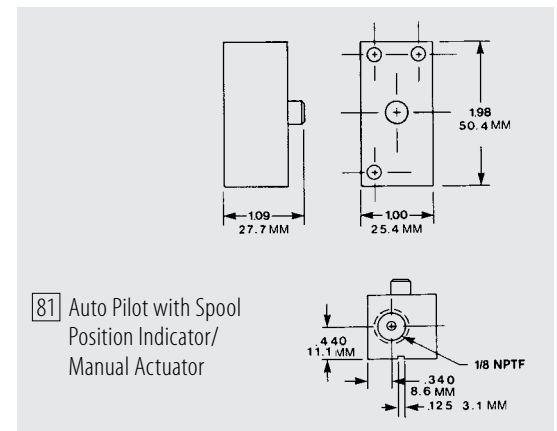

OMNI SERIES VALVES

OMNI 375 SERIES VALVES

3-WAY & 4-WAY MANUALLY OPERATED

Many applications require hand and foot actuation. The OMNI 375 3-Ways and 4-Ways offer a rugged, compact, versatile answer. Mount them in any position. Available with levers, buttons, selectors or foot pedals with spring return or detent.



4-Way Lever

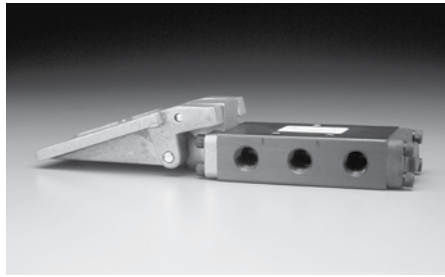

3-Way Foot Pedal



3-Way Palm Button

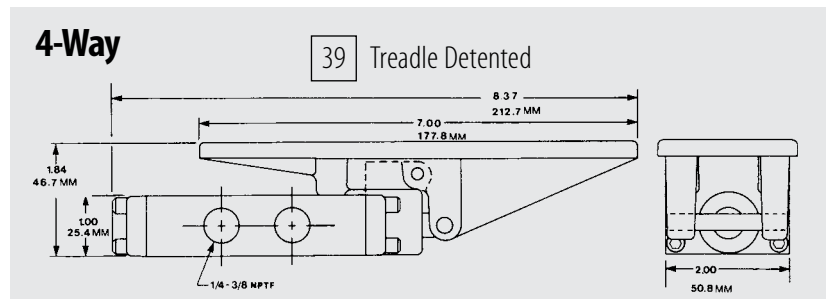
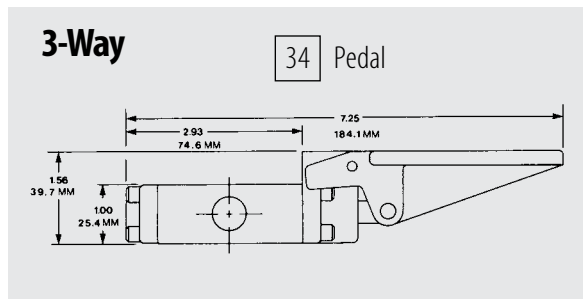
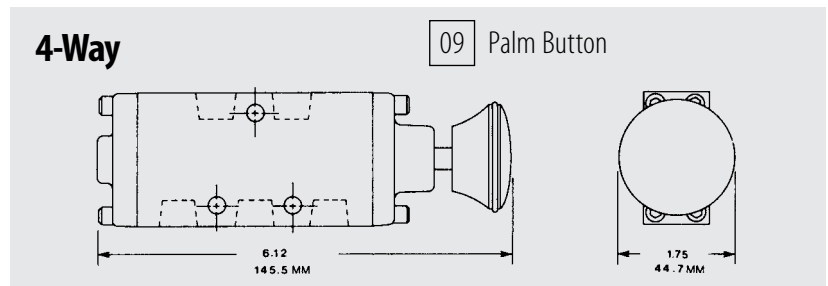
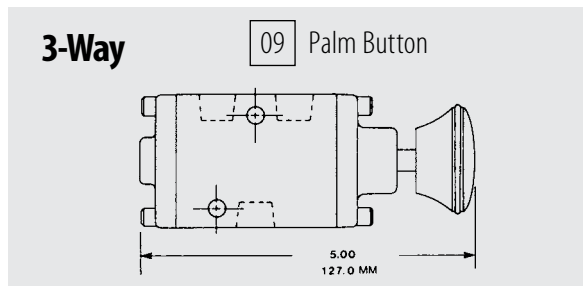
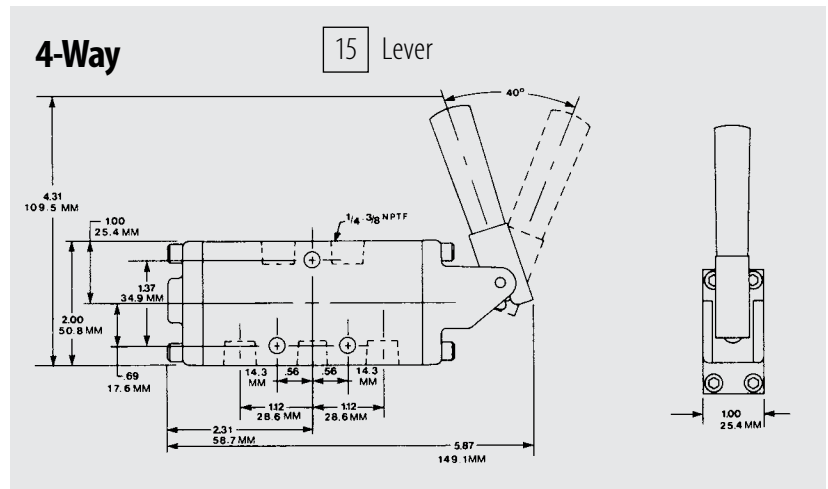
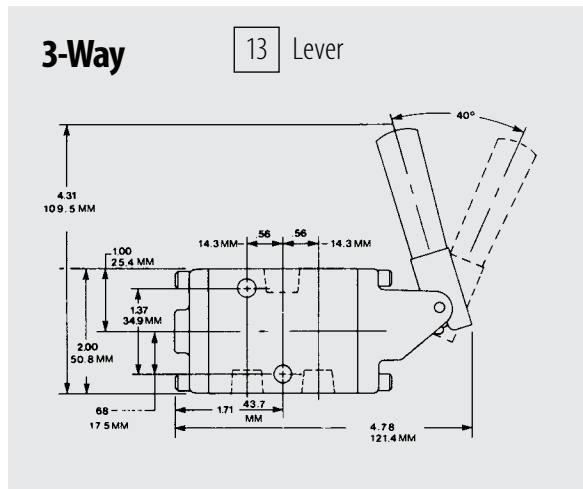

OMNI 375 SERIES VALVES

BASIC VALVE MODEL NUMBERS

DESCRIPTION	3-WAY			4-WAY		
	PIPE SIZE	NUMBER	SCHEMATICS	PIPE SIZE	NUMBER	SCHEMATICS
Palm Button Spring Return	1/4 NPTF	375-02-007-09		1/4 NPTF	375-02-001-09	
	3/8 NPTF	375-02-087-09		3/8 NPTF	375-02-081-09	
Parallel Side Lever with Spring Return	1/4 NPTF	375-02-007-13		1/4 NPTF	375-02-001-13	
	3/8 NPTF	375-02-087-13		3/8 NPTF	375-02-081-13	
Foot Operated Spring Return	1/4 NPTF	375-02-007-34		1/4 NPTF	375-02-001-34	
	3/8 NPTF	375-02-087-34		3/8 NPTF	375-02-081-34	

This Series of 4-Way valves* is available with base mounting which permits the removal or changing of a valve without disturbing the piping. The 375 Series base is machined from extruded aluminum and available with 5 threaded ports in 1/4, 3/8 or 1/2 NPTF. The valve body (004) has 5 unthreaded ports on the wide part of the valve which mate with 5 ports on the top of the base. The body is supplied with 5 Viton O-rings and is assembled to the base.

*Because of operator overhang, not all operators available for base mount.

DESCRIPTION	PIPE SIZE	NUMBER
Lever operated, spring return valve, base mounted, valve only		375-02-004-17
Side Ported Base	1/4 NPTF	375-1401
	3/8 NPTF	375-1402
	1/2 NPTF	375-1405
Side & Bottom Ported Base	1/4 NPTF	375-1168

Note: Valve and bases must be ordered separately.

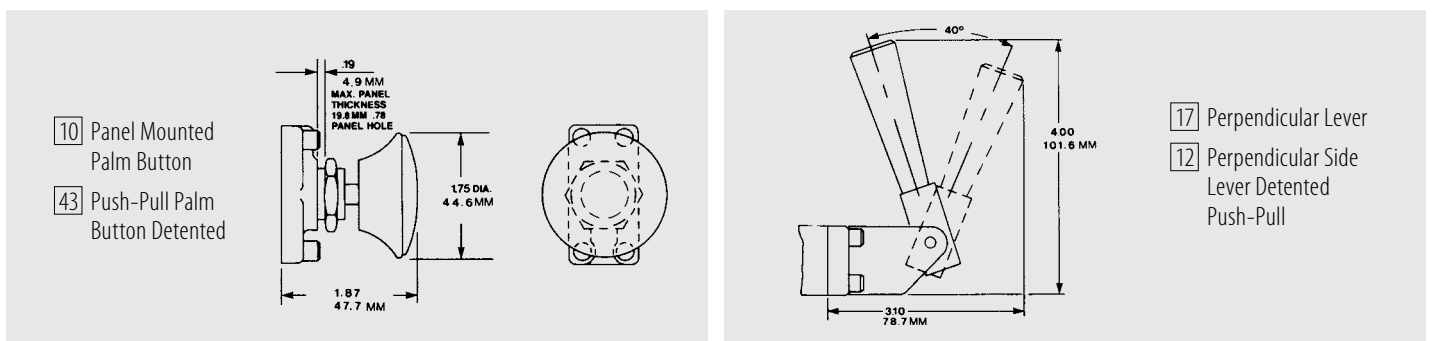
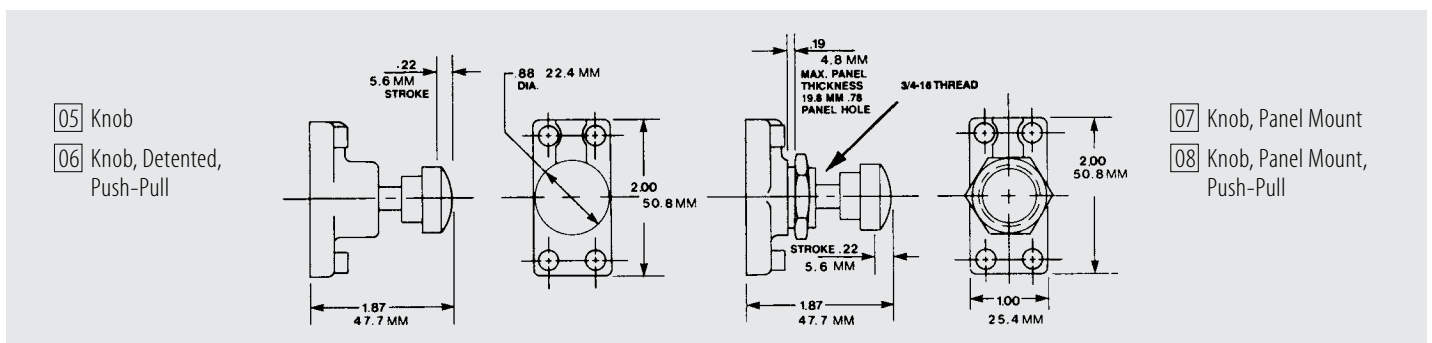

OMNI SERIES VALVES

OMNI 375 SERIES VALVES

3-WAY & 4-WAY MECHANICALLY OPERATED

Cam Operated: The compact OMNI 375 is available with roller lever or steel plunger and can be mounted in any position...375's can squeeze into tight places and deliver high flow.

Roller lever actuation: 3 styles

1. Actuation right (roller lever moved to right operates valve)
2. Actuation left (roller lever moved to left operates valve)
3. 2-Way actuation (when moved either direction operates valve)

The one-way model valve can be actuated in either direction without damage, but only the designated direction will operate valve. See diagrams below for clarification.

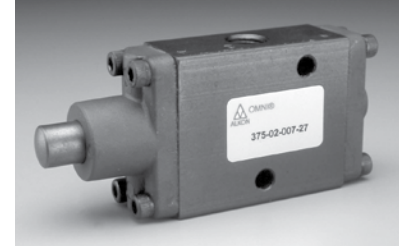

OPERATORS

30	Actuates	Left
31	Actuates	Right
32	Actuates	Both

Note: 8-9 Lb. Actuation force required on roller

3-WAY ORDERING INFORMATION

DESCRIPTION	3-WAY		
	PIPE SIZE	NUMBER	SCHEMATICS
Parallel Roller Lever Actuation Left Spring Return	1/4 NPTF	375-02-007-30	
	3/8 NPTF	375-02-087-30	
Steel Plunger Spring Return	1/4 NPTF	375-02-007-27	
	3/8 NPTF	375-02-087-27	

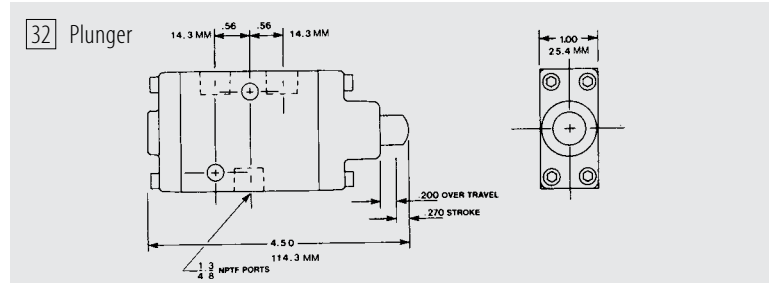
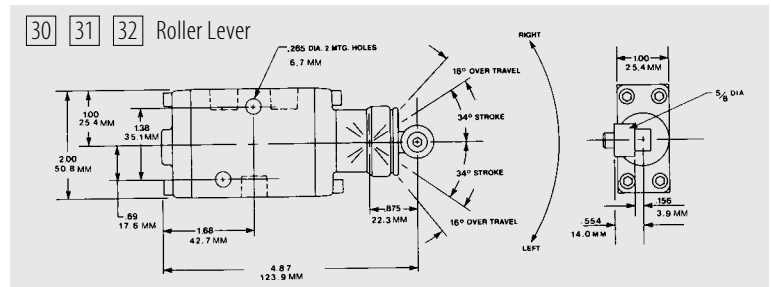

4-WAY ORDERING INFORMATION

DESCRIPTION	4-WAY		
	PIPE SIZE	NUMBER	SCHEMATICS
Parallel Roller Lever Actuation Left Spring Return	1/4 NPTF	375-02-001-30	
	3/8 NPTF	375-02-081-30	
Steel Plunger Spring Return	1/4 NPTF	375-02-001-27	
	3/8 NPTF	375-02-081-27	

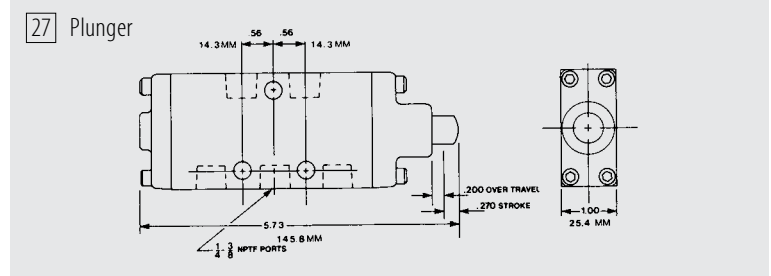
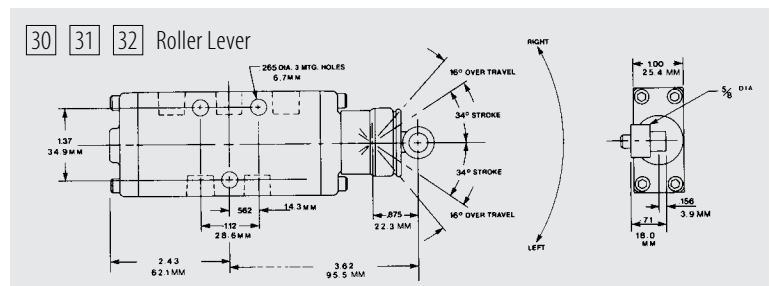

OMNI 375 SERIES VALVES

3 POSITION VALVES

OMNI 375, 3-position valves are designed and engineered to the same standards and ideals of the industry proven and accepted 2-position series. 3-position valves are simple in design, compact, rugged and high flowing. These valves offer the following features:

AIR FLOW DATA		
PORT SIZE	1/4 NPTF	3/8 NPTF
Cv "E" Spool	1.4	1.5
Maxflow SCFM @ 80 PSIG	68	71
Cv "B" Spool	1.4	1.5
Maxflow SCFM @ 80 PSIG	68	71
Cv "P" Spool	1.5	1.7
Maxflow SCFM @ 80 PSIG	71	79

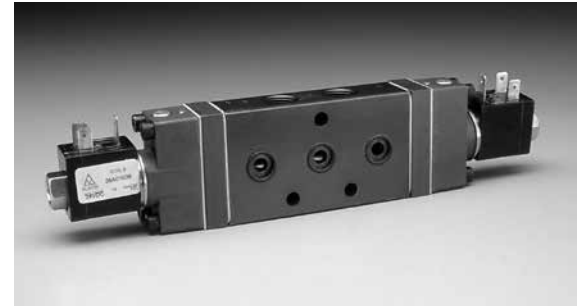
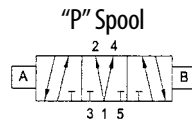
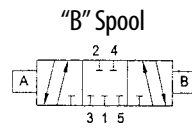
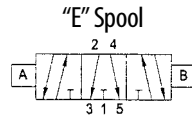

Double Solenoid Spring Centered



Lever Operated Spring Centered

ORDERING INFORMATION FOR 3-POSITION VALVES

375	33T	E01	33T	1
Series (375)	Operator "B" (See Listing)	Body/Base (See Listing)	Operator "A" (See Listing)	Volts/Hertz

BODY STYLES:

B01	1/4 NPTF individual 4-Way blocked center
E01	1/4 NPTF individual 4-Way exhausted center
P01	1/4 NPTF individual 4-Way pressurized center
B81	3/8 NPTF individual 4-Way blocked center
E81	3/8 NPTF individual 4-Way exhausted center
P81	3/8 NPTF individual 4-Way pressurized center
B03	1/4 NPTF stacking 4-Way blocked center
E03	1/4 NPTF stacking 4-Way exhausted center
P03	1/4 NPTF stacking 4-Way pressurized center
B83	3/8 NPTF stacking 4-Way blocked center
E83	3/8 NPTF stacking 4-Way exhausted center
P83	3/8 NPTF stacking 4-Way pressurized center
B08	Manifold body with blocked center
E08	Manifold body with pressurized center
P08	Manifold body with exhausted center
B04	Base mtd. body with blocked center
E04	Base mtd. body w/ pressurized center
P04	Base mtd. body w/ exhausted center

Standard Voltages:

120/60, 240/60, 24/60, 6VDC, 12VDC, 24/VDC.

Dimensional Data:

For spring centered models, add .860" to comparable 2-position valve length. For detented models, add .060" to comparable 2-position valve length.

OPERATORS:

01T	Blank end cap for lever detented
02T	Spring centering for levers
03T	Spring centering air pilot
13T	Spring centering parallel side or straight lever
15T	Detented parallel side or straight lever
17T	Spring centering perpendicular side or straight lever
19T	Detented perpendicular side
33T	Spring centering solenoid air pilot with conduit connection
37T	Spring centering solenoid air pilot with conduit connection & manual override
38T	Spring centering solenoid air pilot with conduit connection locking manual override
42T	Spring centering explosion proof solenoid air pilot with conduit connection & manual override
60T	Spring centering solenoid air pilot with grommet connection
61T	Spring centering solenoid air pilot with grommet connection & manual override
65T	Spring centering solenoid external air pilot with conduit connection & manual override
67T	Spring centering solenoid air pilot with DIN connector
68T	Spring centering solenoid air pilot with DIN connector & manual override
82T	DIN connector, locking manual override

OMNI SERIES VALVES

OMNI 375 SERIES VALVES

STACKING & COMMON WIREWAY ARRANGEMENTS

The OMNI 375 Series valves can be assembled into a variety of stacking arrangements which greatly reduce piping requirements and increases mounting options.

These stacks offer high flow performance in compact, space-saving packages which include:

- 2 and 3 position
- Side or bottom porting - 1/4 or 3/8 NPTF
- 4-Way, 5 ported stacks with common or dual input
- Common or individual dual exhausts
- Horizontal or vertical mounting
- Grommet, conduit, or DIN connector for electrical operators
- NEMA 4 common wireway closure
- Electronic timer



Double Solenoid Spring Centered



Double Solenoid Spring Centered

Ordering Information:

All OMNI 375 Series valve stacks and common wireway stacks are assembled with tie rods at the factory at no additional charge. The ordering procedure is very simple. First, list the quantity and model of each type of valve required. Second, determine the number of spacers required between each valve. When air pilot or DIN operated valves are used, spacers are not required. When manually operated valves are used, allow one spacer between each valve, but not between a valve and end plate. When solenoid operated valves are used (with or without manual override) allow one spacer between each valve, but not between a valve and end plate. For operators 42, 66, or 74 consult factory. Third, specify the type of end plate assembly required (side or bottom ported, 1/4 or 3/8 NPTF, horizontal or vertical). Fourth, for common wireway stacks, specify model enclosure. In most cases where a 3-Way valve function is required in a stack, a pipe plug is used to block one of the cylinder ports.

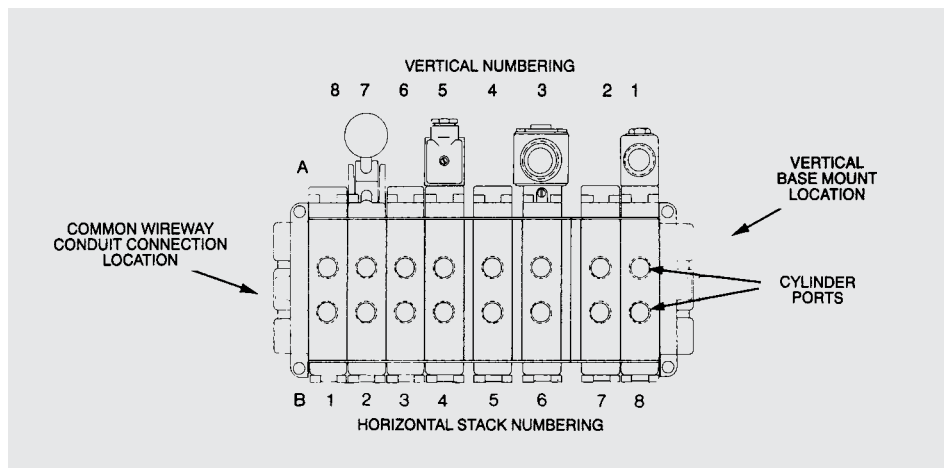

Example for ordering two, 375 Series stacks with common wireway:

- (2) 375 Series common wireway stack consisting of:
 - (4) 375-02-009-68C 120/60 with lights
 - (1) 375-1230 side ported 1/4 NPTF end plate assembly
 - (1) 37-1122 NEMA 4 enclosure

Example for ordering two, 375 Series stacks:

- (2) 375 Series stack consisting of:
 - (3) 375-37-003-37 120/60
 - (2) 375-02-003-37 120/60
 - (4) 375-1240 Spacer Plates
 - (1) 375-1231 bottom ported 3/8 NPTF end plate assembly

NOTE: When ordering, if more than one model number valve is to be stacked, specify valve position by numbering valves from left to right while facing the "B" end operators. If a vertical mounting plate is used, number valves starting from vertical plate.

OMNI 375 SERIES VALVES

Order Numbers for Common Wireway NEMA 4 Enclosure

DESCRIPTION	MODEL
2 valve, single solenoid enclosure	37-1200
2 thru 4 valves, double solenoid enclosure	37-1123
5 thru 6 valves, single solenoid enclosure	37-1124
5 thru 6 valves, double solenoid enclosure	37-1125
7 thru 9 valves, single solenoid enclosure	37-1127
7 thru 9 valves, double solenoid enclosure	37-1128
10 + valves	Consult factory

If any one valve in stack is double solenoid, you must order double solenoid enclosure.

Order Number For Common Wireway & Standard Stack End Plate Assemblies

DESCRIPTION	MODEL
Vertical mount assembly (with 3/8" NPTF ports)	375-1213-3/8
Horizontal mount assembly (specify 1/4" or 3/8" NPTF) side ported plates	375-1230
Horizontal mount assembly (specify 1/4" or 3/8" NPTF) bottom ported plates (for stacks only)	375-1231
Spacer plate (for stacks only)	375-1240

Common Wireway (NEMA 4)

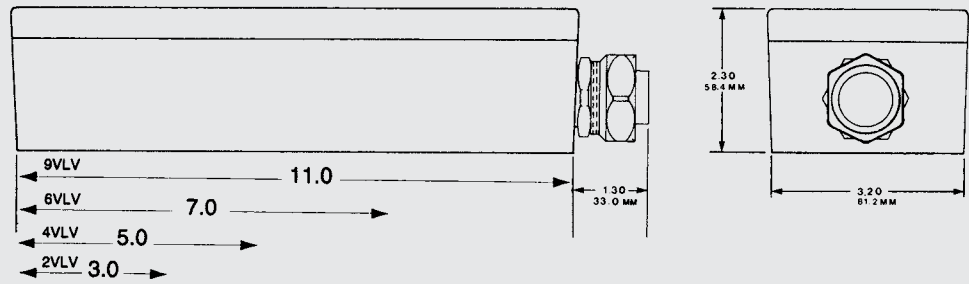

Body Options

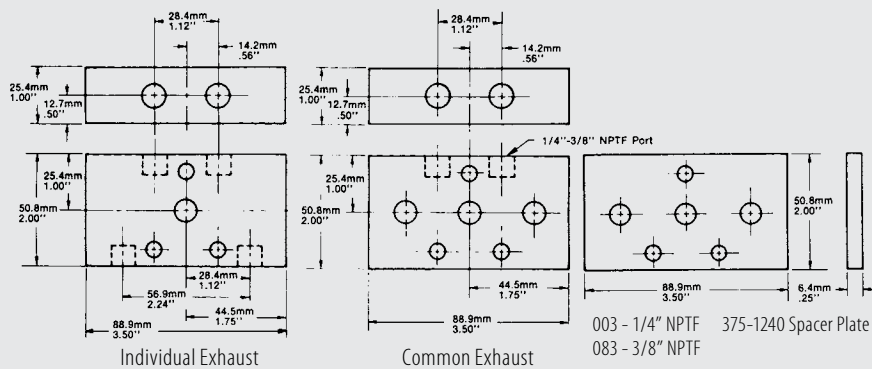

End Plate Assemblies

Note: End Plate Assemblies consist of the following:
2 end plates, 3 tie-rods and all nuts and O-rings needed.

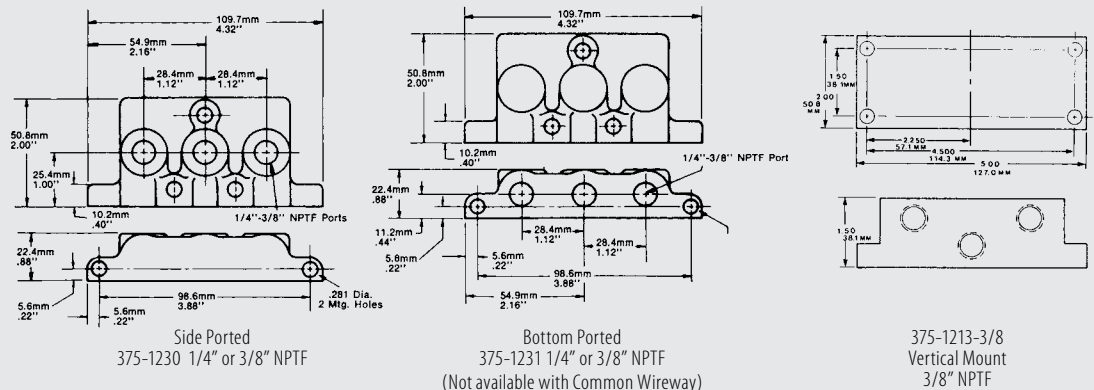

OMNI SERIES VALVES

OMNI 375 SERIES VALVES

MANIFOLD MOUNTED VALVES

The highly reliable standard OMNI 375 valve can also be manifold mounted. This Alkon engineering advancement requires a minimum of piping while providing multiple mounting arrangements, compact rugged design and extremely high air flow. Simple in design, yet sophisticated in performance. The manifold mounted OMNI 375 offers these additional features:

- Complete range of solenoid connectors
- Solenoid, manual or air operators
- Tapped 1/4 or 3/8 NPTF, machined from rugged and extruded anodized aluminum
- SCFM 103 @ 80 PSI
- Cv of 2.2
- All piping arrangements in manifold
- Dual pressure manifolding
- Pin locators insure exact positioning of valves on manifold
- Valves can be easily and quickly added, removed or isolated for changing circuit requirements



Manifold Mounted Valves

Each Alkon manifold is designed to accept two 4-Way 5-ported OMNI valves. For a 3-Way application, one of the cylinder ports in the manifold must be plugged.

Where the manifold is to be mounted vertically, a base plate with a 3/8 NPTF supply port is available (see illustration). Main air supply to manifold is piped directly to 3/8 NPTF end plates. Mounting holes in end plates offer added versatility.

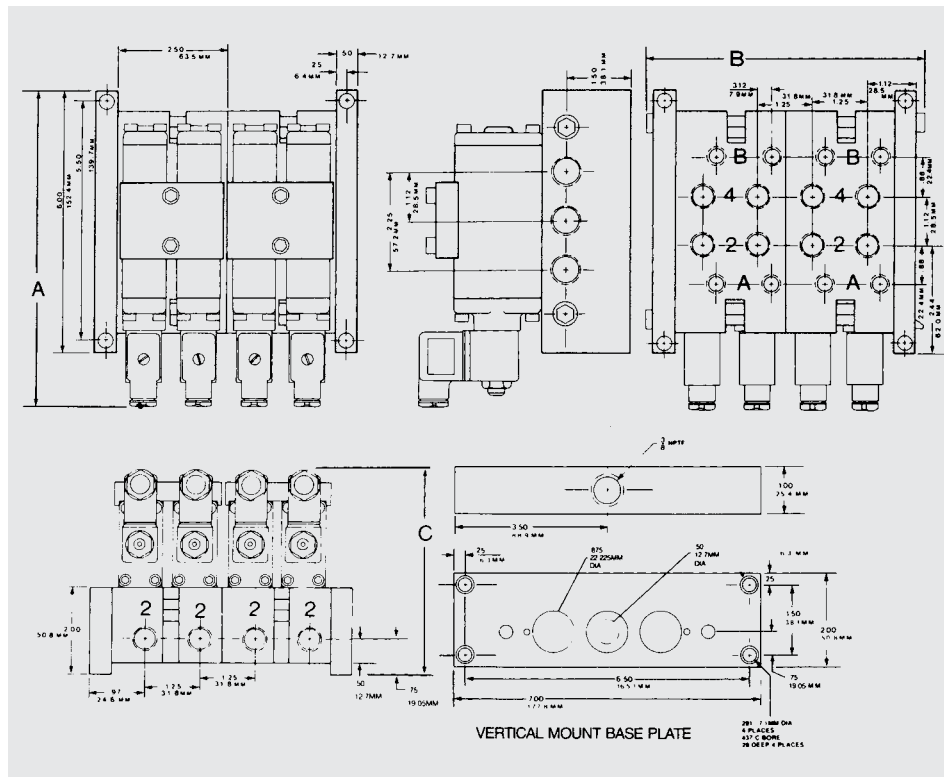

DIMENSION "A"	INCH	MM
Single Solenoid, Spring Return	7.25	184.15
Double Solenoid, Momentary	9.40	338.76
Air Pilot, Spring Return	6.00	152.4
Double Air Pilot, Momentary	6.00	152.4
DIMENSION "B"		
Two Station	3.90	99.1
Three Station	6.40	162.6
Four Station	6.40	162.6
NOTE: For more than four stations, add 2.5 inches for each two station manifold.		
DIMENSION "C"		
Solenoid Operated with Conduit Connection	4.70	119.4
Air Pilot	4.44	112.8

OMNI 375 SERIES VALVES

MANIFOLD VALVES ORDERING INFORMATION

To order an even number of valves, specify the required number of manifolds and valves.

For odd number of valves, order a valve blank for one of the manifold stations or an extra valve for emergency requirements.

ORDER NUMBERS FOR MANIFOLD ONLY	
DESCRIPTION	MODEL
Two station manifold 1/4 NPTF ports, 1/8 NPTF pilot ports (for pilot application) complete with O-rings and tie bolts and tie down clamps	375-1164
Two station manifold 3/8 NPTF ports, 1/8 NPTF pilot ports (for pilot application) complete with O-rings and tie bolts and tie down clamps	375-1166
Right end plate (facing "B" end of manifold) complete with O-rings and hex head bolts 3/8 NPTF	375-1199
Left end plate (facing "B" end of manifold) complete with hex lock nuts, no O-rings* 3/8 NPTF	375-1200
Base Plate for vertical mounting of manifold 3/8 NPTF supply port. Complete with lock nuts and O-rings. (For other end of manifold use right end plate.)	375-1300
Tie-Down Clamp	375-1035
Manifold with Dual Pressure 3/8 NPTF ports	375-1203
Two Station Manifold, 3/8 NPTF ports, complete, for use with 4-2 operators	375-1591

Ordering Sequence for Manifold and Valves

QTY.	DESCRIPTION
1	375 Series Manifold Assembly consisting of:
	(4) 375-1164 manifold 1/4 NPTF
	(7) 375-02M-008-68M valves 120/60
	(1) 375-000 Valve Blank
	(1) 375-1199 Right End Plate
	(1) 375-1200 Left End Plate

Note: If specific valve locations are required, please specify. Blocking discs available to facilitate dual pressure, #32A01032.

ORDERING INFORMATION FOR 3-POSITION VALVES

375	02M	008	33M	120/60
Series (375)	Operator "B" (See Listing)	Body/Base (See Listing)	Operator "A" (See Listing)	Volts/Hertz

BODY	
008	5 Ported 4-Way
000	Valve Blank (order as 375-000 for odd number valves)











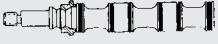





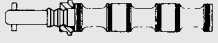
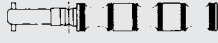

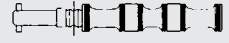



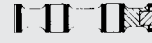

OPERATORS:

01	Blank end cap
02	Spring return
03M	Air pilot
04M	Air pilot spring offset
13	Lever, parallel
15	Lever, parallel, detented
33	Solenoid air pilot with conduit connection
37	Solenoid air pilot with conduit connection and manual override
38	Solenoid air pilot with conduit connection and locking manual override
42	Solenoid with explosion-proof housing
60	Solenoid air pilot with grommet connection
61	Solenoid air pilot with grommet connection and manual override
65M	Solenoid external air pilot with conduit connection and manual override
67	Solenoid air pilot with DIN
68	Solenoid air pilot with DIN connector and manual override
81M	Air pilot with spool position indicator / manual actuator

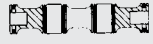
OMNI SERIES VALVES

OMNI 375 SERIES VALVES

REPLACEMENT PARTS

OPERATOR NO.	SPOOL REPLACEMENT*
06, 08, 43	 3-Way 2 Position 90A20095  4-Way 2 Position 90A20106
13, 17	 3-Way 2 Position 90A20078  4-Way 2 Position 90A20075  3 Position B 90A20182  3 Position E 90A20183  3 Position P 90A20184
15, 19	 3-Way 2 Position 90A20112  4-Way 2 Position 90A20113  3 Position B 90A20185  3 Position E 90A20186  3 Position P 90A20187
Foot Pedal 34, 39	 3-Way 2 Position 90A20116  4-Way 2 Position 90A20117
42	<div style="display: flex; justify-content: space-around;"> <div style="text-align: center;"> <p>3-Way 2 Position</p>  Single 90A20075  Double 90A20132 </div> <div style="text-align: center;"> <p>4-Way 2 Position</p>  Single Solenoid 90A20188  Double Solenoid 90A20189 </div> <div style="text-align: center;">  3 Position B 90A20190  3 Position E 90A20078  3 Position P 90A20205 </div> </div>
27, 30, 31, 32	 3-Way 2 Position 90A20201  4-Way 2 Position 90A20127
All Others	 3 Position B 90A20175  3 Position E 90A20176  3 Position P 90A20177  3-Way 2 Position 90A20078  4-Way 2 Position 90A20075

*Material: Aluminum is standard. Derlin available on some operators. Consult factory.

COIL REPLACEMENT

DESCRIPTION	MOLDED
Coil with conduit housing 33, 37, 38, 65 operators, 7 watt	26A01017
Coil with grommet housing 59, 60, 61 operators, 7 watt	26A01033
Coil for explosion proof housing 42 operators, 7 watt	26A01043
Coil for DIN connector, 8.5 watt	26A01039

When ordering coil, give part no. and voltage. Standard voltages are: 120/60, 240/60, 6VDC, 12VDC, 24VDC. For other voltages consult factory.

Torque Settings for Coil Hold Down Nuts are:

- 20-25 in-lbs. for Canned type operators
- 20-25 in-lbs. for DIN operators
- 55 in-lbs. for operators 42

STAINLESS STEEL 316 SERIES

ORDERING INFORMATION FOR STAINLESS STEEL 316 SERIES

316	02	001	38	1
Series (316)	Operator "B" (See Listing)	Body/Base (See Listing)	Operator "A" (See Listing)	Volts/Hertz
		001 = 1/4 NPTF ported (375 size) individual 4-Way		1 = 120/60 AC
				5 = 24 VDC

OPERATORS:

01	Blank end cap
02	Spring end cap
03	Air pilot
15	Lever detented parallel push-pull
38	Conduit connection locking manual override
41	Explosion-proof conduit connection, locking manual override, stainless steel

*Denotes standard voltages.

Ordering Procedure for Stainless Series 316:

- 1. Series Designation** – 316 identifies 316 series stainless.
- 2. "B" Operator** – This is the secondary operator. The secondary operator returns the spool.
- 3. Body Style** – 1/8" body available in 4-Way only, but can be plugged to make 3-Way or 2-Way.
- 4. "A" Operator** – This is the primary operator. The primary operator moves the spool away from the start position.
- 5.** Specify voltages or any other special conditions.



STAINLESS STEEL 316 SERIES

ENGINEERING & TECHNICAL DATA

MATERIAL

- 316 Series – Metal components are 316 stainless steel excluding standard solenoid operator.

BODY STYLE

- 1/4 NPTF ported – 3-Way bodies and 4-Way bodies.

CONFIGURATIONS

- Solenoid, air, and manual actuators, In-line.

LUBRICATION

- All valves are pre-lubricated and will operate dry (with no additional lubrication). However, a lubricated system will greatly extend the service life of any valve.

“THIN-LIP” SEAL & SPOOL

- PTFE loaded Viton seals provide millions of trouble-free cycles.
- Minimal breakout friction.
- Unique wiping action eliminates contaminate buildup in bore.
- Reduces spool hang-up due to compressor or oil varnishing.
- Operates effectively in lubricated or non-lubricated systems.

SOLENOID HOUSING CLASSIFICATIONS

Conduit and Grommet Housings with Molded Coils Meet:

- NEMA 1 General Purpose = Indoors
- NEMA 2 Drip-proof = Indoors
- NEMA 3 Drip-tight = Indoors
- NEMA 4* Watertight & Dust-tight = Indoors & Outdoors
- NEMA 6* Submersible, Watertight, Dust-tight & Sleet-Ice Resistant = Indoors & Outdoors

*Specify “Potted” Coil Option to meet NEMA 4 & 6.

Explosion Proof Housings Meet:

- NEMA 7C, 7D & CSA Class I = Groups C & D = Explosion Proof
- NEMA 8C, 8D & CSA Class I = Groups C & D = Explosion Proof
- NEMA 9E, 9F, 9G & CSA Class II = Groups E, F & G = Explosion Proof

VALVE OPERATING SPECIFICATIONS

MEDIA:	Air & Gas
PRESSURE RANGE:	Main Supply: 40 - 150 psig (standard) Vacuum to 40 psig is available
	Sol. Pilot Air: Minimum 40 psig to 150 psig and not less than the main air supply. For lower pilot pressure consult factory.
TEMPERATURE RANGE:	0°C to 85°C 32°F to 180° F

For other temperatures consult factory.

FLOW DATA

PORT	Cv	SCFM at 80 psi
1/4 NPT	2.2	104

REPLACEMENT PARTS / SPOOL REPLACEMENT

AIR & SOLENOID		S.S.
1/4 NPTF	Single & Double Pilot	90A20295

SOLENOID DATA

STANDARD VOLTAGES	CURRENT (AMPS)	
	INRUSH	HOLDING
120/60AC	.11	.07
24VDC	.29	.29

Other AC and DC voltages available special order.

Note: 120/60Hz can be connected to 110/50Hz.

Molded epoxy coils standard.

Explosion-proof solenoids available.

COIL REPLACEMENT

DESCRIPTION		MODEL
Coil with conduit housing	38 operators	26A01017
Coil for explosion-proof housing	41 operators	26A01043

When ordering coil give part no. and voltage.

Standard voltages are; 120/60, 24VDC. For other voltages consult factory.

LOC-MASTER®

SAFETY LOCK OUT & EXHAUST AIR VALVES MANUAL & ELECTRIC

SIZES AVAILABLE: 1/2, 3/4, 1-1/4, 2 & 2-1/2" NPTF

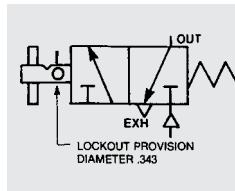

Loc-Master has long been the industry's first choice in safety bleed valves; available in 3/8, 1/2, 3/4, 1 & 1-1/4 NPTF sizes. All valves have telescoping handle and provision for locking in off position only.



Operation – Loc-Master (LM)

Push handle in and one quarter turn to detent – inlet open to outlet, exhaust blocked.

One quarter turn of operating stem from detent position allows valve to spring return, shutting off supply and simultaneously exhausts downstream air not trapped by some other system component.



Operation – Quick Loc-Master (QLM)

Quick Loc-Master with ball handle operates same as above (LM) except actuation and de-actuation take place in 45° increments to allow for even quicker shut off.



Operation – Slow Loc-Master (SLM)

Slow Loc-Master is designed to allow operator to control rate of air flow when charging or exhausting a pneumatic system. Three full turns of knob are required to open valve fully and three full turns in opposite direction to close valve and exhaust downstream air. After system is charged, valve should always be placed in full open position for best operation.

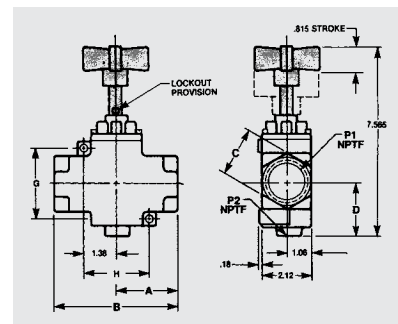
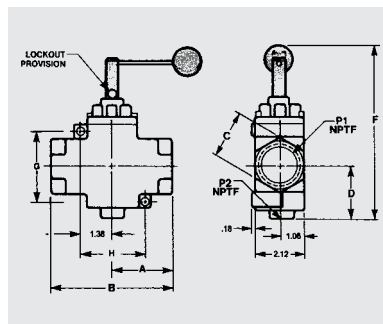
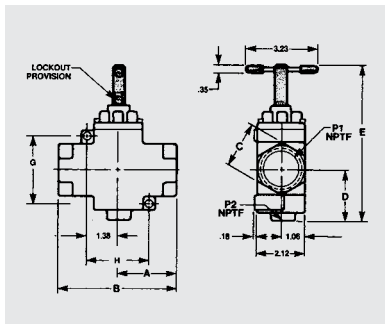

SPECIFICATIONS

- 0 – 150 psig
- Viton Seals
- 40 Micron Filtration
- 40° to 180° F

FLOW DATA

NPT	Cv	SCFM ATMOSPHERE @80 PSIG	WEIGHT
1/2	5.3	242	1 lb. 8 oz.
3/4	11	495	2 lb.
1-1/4	14	647	2 lb.

INSTALLATION DATA (in inches)

MODEL NUMBER	P1 NPTF IN-OUT	P2 NPTF	A	B	C	D	E	F	G	H	I	J
LM50 QLM 50	1/2	1/4	2.08	4.16	1.37	1.60	5.75	6.00	2.125	2.625	1.312	.15
LM75 QLM 75 SLM 75	3/4	1/2	2.72	5.43	2.12	2.39	6.90	6.90	2.719	2.686	1.343	.18
LM125 QLM 125 SLM 125	1-1/4	1/2	2.72	5.43	2.12	2.39	6.90	6.90	2.719	2.686	1.343	.18

LOC-MASTER

MINI BAZOOKA LOC-MASTER®

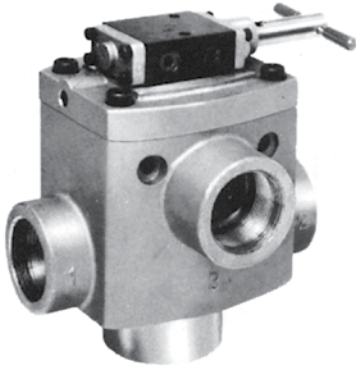

MINI BAZOOKA and BIG BAZOOKA Loc-Master valves are ported 1-1/2 and 2 NPTF to be used as system supply valves and in applications requiring high air flow capacity. The valves are 3-Way normally closed and operated by integral manual pilot valves. The pilot valves can be locked in the off position only.

Operation

Push handle in and one quarter turn to detent port 1 open to port 2, port 3 is blocked. One quarter turn of handle from detent allows valve to spring return shifting off port 1 and opening port 2 to port 3 exhaust downstream air (not trapped by some other system component).

SPECIFICATIONS:

- 30 - 150 psig
- 40 Micron Filtration
- Viton Seals
- 40° to 180°F

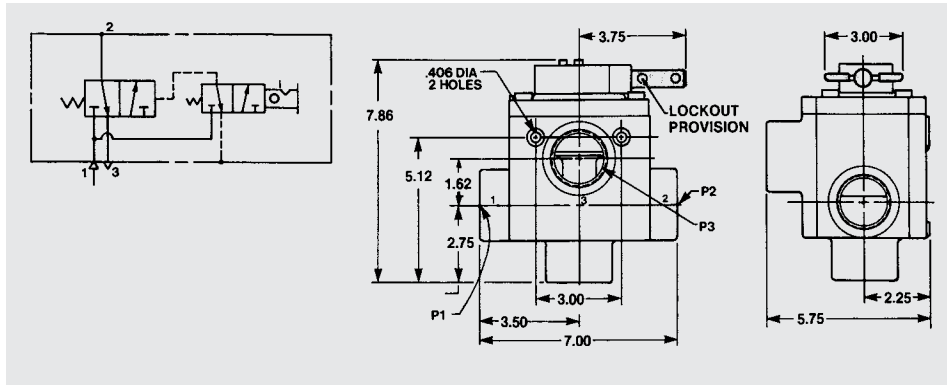

BIG BAZOOKA LOC-MASTER®

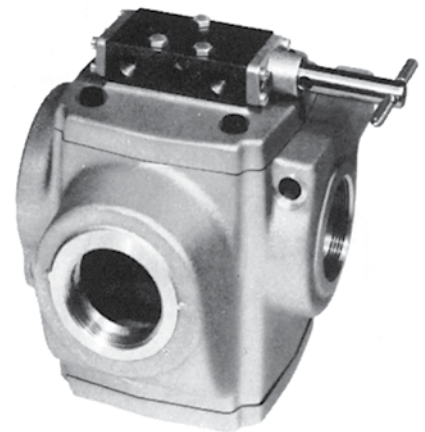
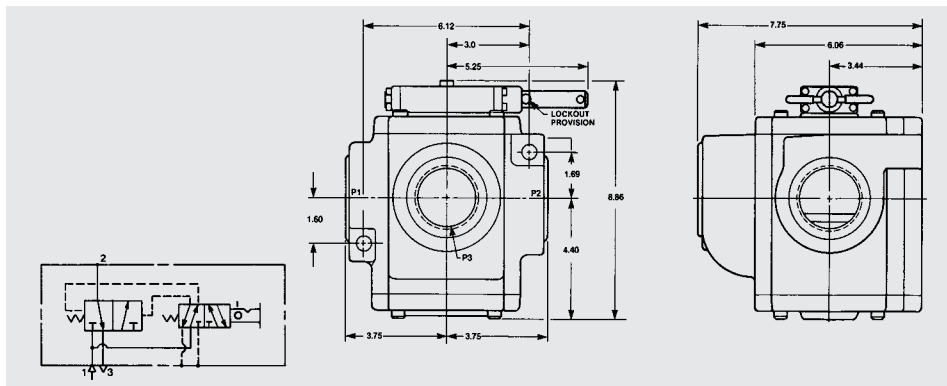

Model No.	Port Size NPTF			Cv	Max. SCFM @80 PSIG
	1	2	3		
MB045-31-15	1-1/2	1-1/2	1-1/2	34.2	1612
BB045-31-20	2	2	2	51.0	2397

“ELECTRO-LOC” LOC-MASTER®

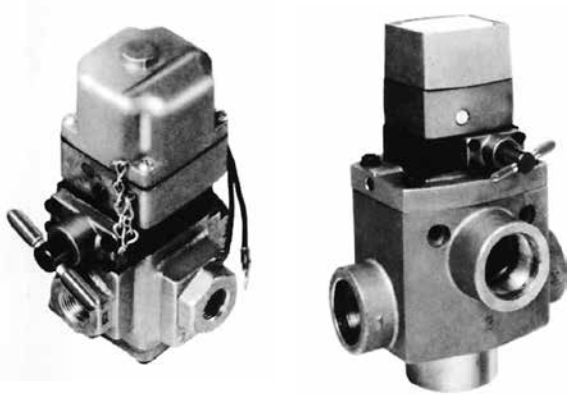

The newest lockout valves from Alkon provide a manual lock out feature on 3-Way solenoid valves. Both manual and solenoid pilot actuator must be operated for valve to open. Shutting off either manual or solenoid operator causes valve to shift to off position blocking inlet and exhausting downstream air. Manual actuator may be locked off to prevent valve operation.

Available in port sizes 1/2, 3/4 and 1 NPTF.

SPECIFICATIONS:

- 30 - 150 psig
- 40 Micron Filtration
- Viton Seals
- 40° to 180°F

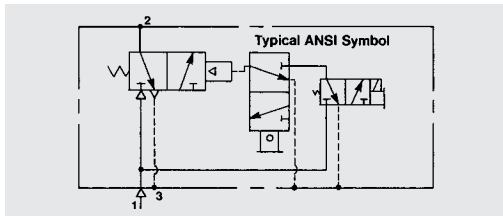
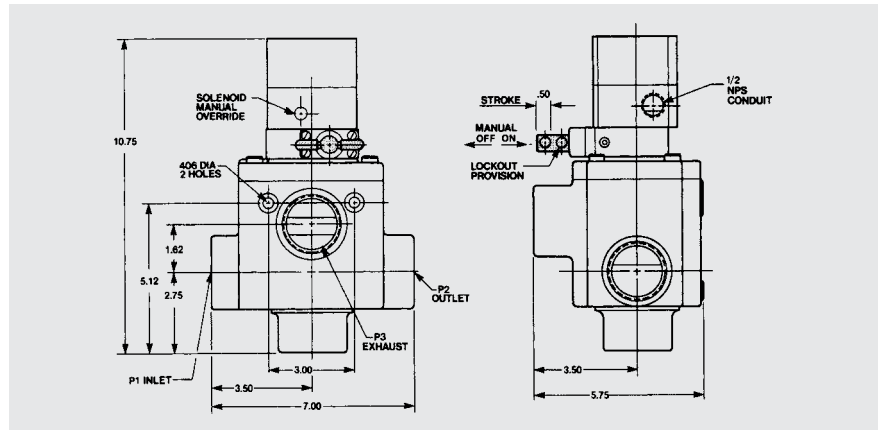
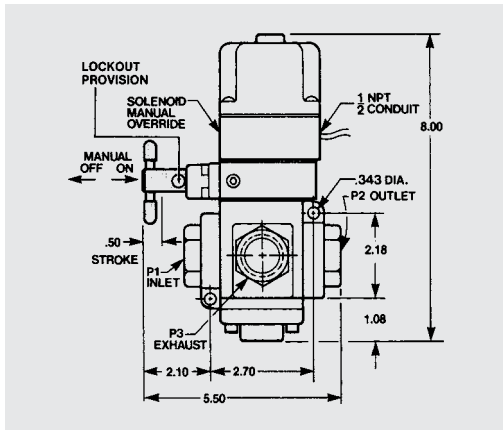

Model No.	Port Size NPTF			Cv	Max. SCFM @80 PSIG
	1	2	3		
3097-50	1/2	1/2	1/2	5.2	244
3097-75	3/4	3/4	3/4	5.7	268
3097-100	1	1	1-1/2	24.2	1137

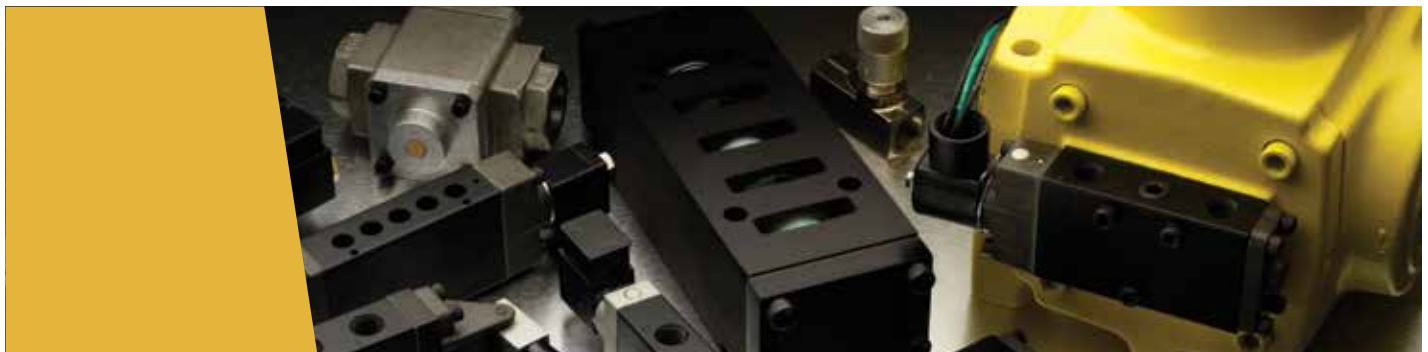

BAZOOKA

MINI BAZOOKA

MINI BAZOOKA is a 3-Way, 2-Position High Flow Air Valve – designed and built for tough industrial applications. We call it “Mini” because it’s a smaller version of the popular industry veteran, the BIG BAZOOKA.

- **HIGH FLOW RATE:** Over 34 Cv
- **LOW BREAKOUT FRICTION:** Alkon “Thin Lip” Seals virtually eliminate breakout friction insuring rapid response...even at low pressure.
- **VERSATILITY:** Can be piped to provide six different functions. Use MINI BAZOOKA for 2-Way, 3-Way, selector and diverter applications. It can be externally piloted for vacuum or low pressure service. Porting options, operator options, and mounting options make MINI BAZOOKA the most versatile valve of its type.



SOLENOID DATA

	120/60 Hz	24VDC
IN RUSH	.25 amps	.5 amps
HOLDING	.11 amps	.5 amps

AIR FLOW DATA

PORT SIZE 1 & 2	1-1/2 NPTF	
NORMALLY CLOSED	IN TO OUT	OUT TO EXHAUST
CV	34.3	33.0
MAX FLOW SCFM @ 80 PSIG	1610	1549

DIMENSIONAL DATA

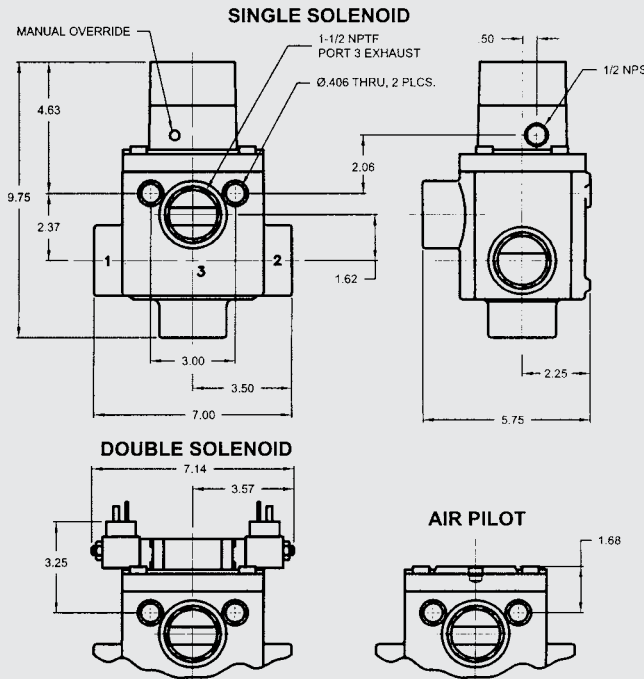

REPAIR PARTS

SOLENOID PILOT		VALVE BODY		
Complete Solenoid Pilot Assembly – Non-Locking	91A20085	Spool Assembly with Seals	N.C. 90A20158	N.O. 90A20159
Solenoid Assembly	09A01033	O-Rings	08A01064 08A01074	
Coil	26A01000	Spring	07A01077	

MINI BAZOOKA

ORDERING INFORMATION FOR MINI BAZOOKA

MB 331	31	12	L	1
Pilot Valve Operators	Main Valve Options	Port Size Designation	Optional	Volt & Cycles
331 = SINGLE SOLENOID with non-locking manual override spring return	21 = 2-Way - Normally Closed (3 Port Plugged)	15 = 1-1/2 NPTF		1 = 120/60
031 = AIR PILOT spring return (Momentary Contact)	31 = 3-Way - Normally Closed			5 = 24VDC

Non Locking Manual Override Standard on Solenoid Valves

See Piping Instructions - Shown Below

MAIN VALVE BODY DATA

ANSI SYMBOLS

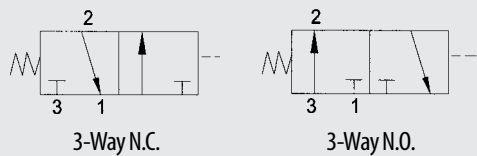

Valve may be mounted in any position

Dynamic Seals: Viton

Maximum Operating Pressure: 125 psig

Minimum Operating Pressure: 30 psig

Media: Air only

External Pilot Available for Low Pressure Vacuum Applications (specify)

Shipping Weight Approx. 12 lbs.

PIPING ARRANGEMENTS

APPLICATION	PORT #1	PORT #2	PORT #3
3-Way Normally Closed	Supply	Outlet	Exhaust
3-Way Normally Open	Supply	Outlet	Exhaust
2-Way Normally Closed	Supply	Outlet	Plugged
2-Way Normally Open	Supply	Outlet	Plugged
LOC-MASTER 3-Way Normally Closed – Only	Supply	Outlet	Exhaust



BAZOOKA

BIG BAZOOKA

BIG BAZOOKA with a Cv of 45 offers a large enough flow rating to safely control a complete industrial air system. For example: In solenoid operation, it could be held in an energized position, feeding air to a complete automation system. Should the system's main disconnect be moved to the off position, BIG BAZOOKA shuts off and bleeds the complete system.

BIG BAZOOKA is also available manually operated with safety lock or air pilot operated.



MAIN VALVE – 2 or 3-Way Function

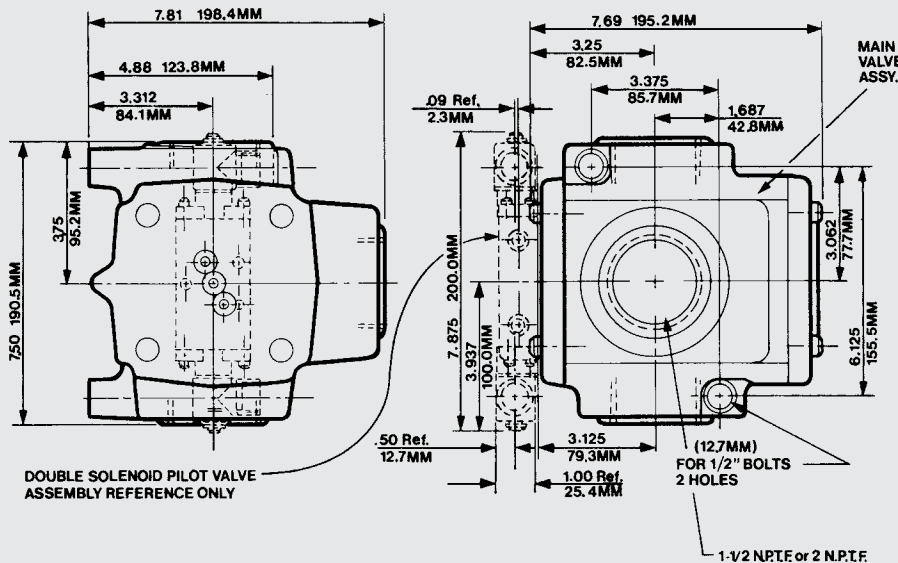

CAUTION: Air exhaust of this capacity can be dangerous. Installation of an Alkon silencer will protect personnel and keep the exhaust sound level within OSHA standards.

Compare these Alkon Features...

- Full ported and rated. Basic minimum orifice: 2.06 inches
- Versatile – can be piped for 6 different applications
- Closed crossover design prevents cross-bleeding and allows complete versatility in piping
- Pilot valve design allows complete design & application freedom
- Unique orifice arrangement provides extremely compact design with maximum flow
- “Thin Lip” spool seal design provides negligible breakout friction and fast response
- Solenoid models: Solenoid pilot assembly
- Can be line or foot mounted in any position
- External pilot can be supplied for low pressure and vacuum applications

SOLENOID OPERATED



The solenoid pilot valve operator provides remote electrical operation of the main valve assembly. SINGLE – MAINTAINED CONTACT

PILOT OPERATED

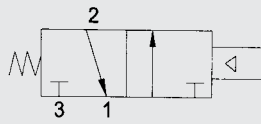

The air operated pilot valve provides remote operation of the main valve assembly without any electrical interface, from any manual, mechanical or remote valve pilot signal. SINGLE – MAINTAINED CONTACT

BIG BAZOOKA

ORDERING INFORMATION FOR BIG BAZOOKA

BB 331	301	20	1	120V/60Hz	E
Pilot Valve Operators	Main Valve Options	Port Size Designation	Accessories & Options	Volt & Cycles (Specify)	External Pilot
331 = SINGLE SOLENOID with non-locking manual override spring return	20 = 2-Way - Normally Closed (3 Port Plugged)	20 = 2 NPTF	MANUAL OVERRIDE Non-Locking-Solenoid Models Only – Standard	1 = 120/60	
031 = AIR PILOT spring return (Momentary Contact)	21 = 2-Way - Normally Open (3 Port Plugged)	25 = 2-1/2 NPTF		5 = 24VDC	
	31 = 3-Way - Normally Closed			Other voltages and explosion proof models available.	

See Piping Instructions – Shown Below

MAIN VALVE

Valve may be mounted in any position

Minimum Orifice: 2.06 inches

Maximum Operating Pressure: 125 psig

Minimum Operating Pressure: 30 psig

Media: Air only

External Pilot Available for Low Pressure/Vacuum Applications (specify)

SOLENOID DATA

Pilot operated coils with self compensation plungers. Solenoid Assembly guaranteed for life of valve.

P.S.I.G

CV = 45 70 - 2150 S.C.F.M.

	120/60
Inrush Current	.11 amps
Holding Current	.068 amps

Other voltages and explosion proof models available.

PIPING ARRANGEMENTS

APPLICATION	PORT #1	PORT #2	PORT #3
3-Way Normally Closed	Supply	Outlet	Exhaust
3-Way Normally Open	Supply	Outlet	Exhaust
2-Way Normally Closed	Supply	Outlet	Plugged
2-Way Normally Open	Supply	Outlet	Plugged
Directional Valve (requires external pilot)	Closed Outlet	Supply	Open Outlet
Selector Valve (requires external pilot)	Supply	Outlet	Supply
Loc-Master	Supply	Outlet	Exhaust

INDY AU SERIES

INDY AU SERIES

OPERATING SPECIFICATIONS

- Media:** Air and inert gasses
- Filtration:** 40 microns
- Pressure Range:** Pilot Air - Maximum 30 psig to 150 psig and not less than main air supply
Vacuum to 30 psig available
Main Supply - 30 to 150 psig (standard)
- Temperature:** 0° to 180° F
- Flow Capacity:** 1.4 to 12.5 Cv
- Lubrication:** All valves are pre-lubricated and will operate with dry air (no additional lubrication required). However, a lubricated system will greatly extend the service life of any valve.



ELECTRICAL

AU-1 & AU-2 ELECTRICAL CHARACTERISTICS			
Standard Voltage	Inrush Current	Holding Current	Power
120 VAC 50/60 Hz	60mA	50mA	6 watts
24 VDC	60mA	60mA	1.44 watts

AU-1 & AU-2 MULTIPLE VOLTAGE ELECTRICAL CHARACTERISTICS			
Standard Voltage	Inrush Current	Holding Current	Power
24 - 120 VDC	55mA±10%	50mA±10%	Actual Voltage x .055
48 - 120 VAC 50/60 Hz	125mA±25%	50mA±10%	Actual Voltage x .055

AU-5 ELECTRICAL CHARACTERISTICS			
Standard Voltage	Inrush Current	Holding Current	Power
110 VAC 50/60 Hz	130mA	80mA	8.8 watts
120 VAC 50/60 Hz	110mA	70mA	8.4 watts
240 VAC 50/60 Hz	60mA	30mA	7.2 watts
24 VDC	290mA	290mA	6.9 watts

- 120/60 Hz can be connected to 110/50 Hz
- Encapsulated coils are standard
- All solenoids are designed to meet or exceed UL and CSA standards
- Coils are rated for continuous duty

ANSI Symbols

2Position "O" Spool



3Position "B" Spool

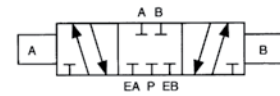

3Position "P" Spool

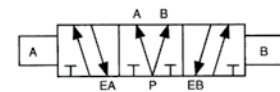

3Position "E" Spool

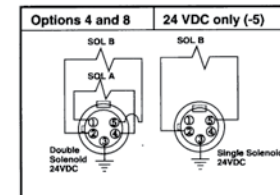
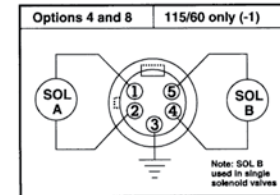
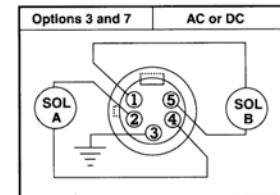

Cv CONVERSION TO SCFM

Cv	PSIG	SCFM
1	40	27
1	50	32
1	60	37
1	70	42
1	80	47
1	90	52
1	100	57

INDY AU SERIES VALVES (Automotive Common Interface)

ORDERING INFORMATION FOR INDY – Valve Assembly Designation *(Does not include base)*

AU1	02	0	3	02	1
Series	Operators "A"	Body		Operators "B"	Volts/Hertz
AU1 = Automation 125		0 = 2-position	3 = Five-pin male electrical MINI plug in top of valve (Ford wiring spec.)		1 = 10/115 VAC 50/60 Hz standard
AU2 = Automation 250		B = 3-position blocked center	4 = Five-pin male electrical MINI plug in top of valve (Chrysler wiring spec.)		5 = 24V DV-standard
AU5 = Automation 500		P = 3-position pressurized center	5 = Air pilot body		M = Multiple Voltage 24 VDC to 120 VDC 48 VAC to 120 VAC 50/60 Hz (AU-1 & AU-2 only)
		E = 3-position exhaust center	7 = Five-pin electrical MICRO AC plug (Ford wiring spec.)		
			8 = Five-pin electrical MICRO AC plug (Chrysler wiring spec. #39986)		

For other voltages consult factory.

OPERATORS A & B END

Spring Return, Air Assisted	02
Air Pilot	03
Solenoid-air pilot with manual override	37

(For use at "B" end only on single solenoid valves)

ORDERING INFORMATION FOR INDY

Base/Manifold Assembly Designation *(Does not include valve)*

AU1	1	1	0
Series	Base		
AU1 = Automation 125	1 = Standard base	1 = 1/8" NPT	0 = Side ports (base)
AU2 = Automation 250	2 = Manifold base*	2 = 1/4" NPT	1 = Bottom ports (base) AU2** & AU5 only
AU5 = Automation 500	3 = Blank station base	3 = 3/8" NPT	2 = Bottom-ported manifold (with common exhaust)
		4 = 1/2" NPT	3 = Bottom-ported manifold (with individual exhaust) AU2 & AU5 only
		5 = 3/4" NPT	4 = End-ported manifold (with common exhaust) AU1 only
		6 = 1" NPT	

Transition Plates: Manifold

Use to combine AU valves of two different sizes in one manifold combination.

AU1+2 combines AU1 & AU2 valves.

AU2+5 combines AU2 & AU5 valves.

*AU1 (only) requires End Plate Assembly

**3/4" NPT port not available on AU2 base

REPLACEMENT PARTS

REPLACEMENT SPOOL (includes seals)

	AU-1	AU-2	AU-5
Option "O" Spool	90A20335	90A20341	90A20260
Option "B" Spool	90A20336	90A20345	90A20292
Option "E" Spool	90A20337	90A20346	90A20294
Option "P" Spool	90A20338	90A20347	90A20293

REPLACEMENT SOLENOID ASSEMBLIES

	AU-1 & 2	AU-5
Voltage "1"	91A30167	Consult Factory
Voltage "5"	91A30168	Consult Factory

When ordering parts, please include complete valve number.

GLASS VALVES

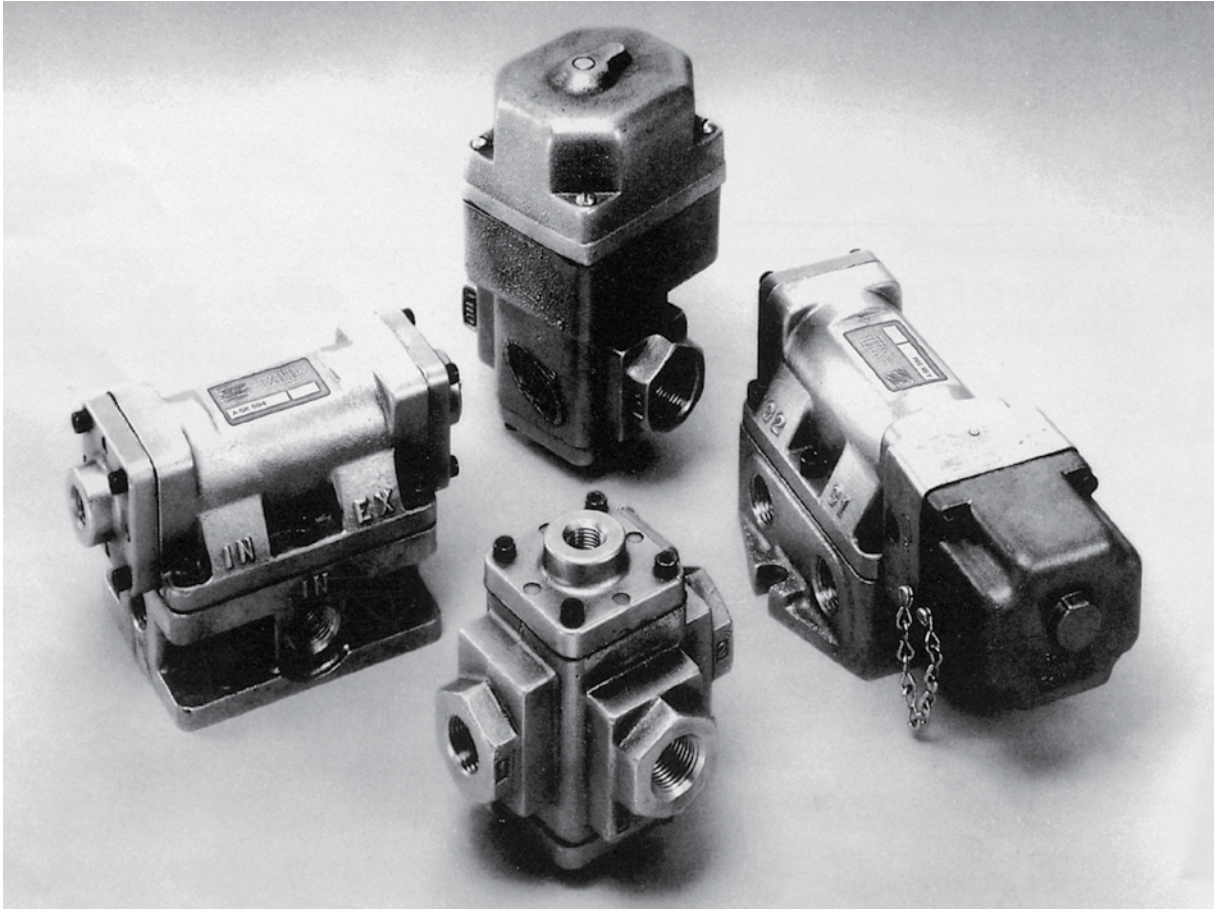

SOLENOID DATA

“VP” Solenoid

- Solenoid-Manual Override Standard
- Inrush Current @ 120V = .26 amps
- Holding Current .16 amps
- Coils are molded epoxy and rated for continuous duty

DIRECT SOLENOID

- Standard (AC) voltage 115v/60 Hz
- Electrical Data = 1/2- 3/4 NPTF Voltage 115/60
- Inrush = 4.2 amps
- Holding = 0.6 amps
- Solenoids are rated for continuous duty

Cv FACTOR

PORT SIZE				
NPTF	1/2	3/4	1	1-1/4
2-Way	4.9	5.5		
3-Way	5.2	5.7		
4-Way	4.2	4.2		

AIR FLOW @ 80 PSIG (SCFM)

	1/2	3/4	1	1-1/4
2-Way	230	259		
3-Way	244	268		
4-Way	197	197		

ENGINEERING DATA FOR ALL DETROIT LINE VALVES

Lubrication

All Alkon valves are pre-lubricated with PTFE-based grease and will operate dry (with no additional lubrication). However, a lubricated system will greatly extend the service life of any valve. The following oils are popular, easily obtained fluids that are recommended for use with Alkon valves: Gulf Harmony 47, Mobil DTE Medium, Shell Tellus 29, Texaco Rondo B., Schivis 47 and Sunnis 921. Many other fluids are acceptable lubricants providing they do not contain detergents that will attack Buna N or Viton seals.

Spool Replacement for Detroit Line Valves

VALVE MODEL	PART NO.
NCVP21-S-50/75	90A20002
NOVP21-S-50/75	90A20009
VP22-S-50/75	90A20002
NC21-S-50/75	90A20026

NO21-S-50/75	90A20032
22-S-50/75	90A20034
NC21-M-50/75	90A20002
NO21-M-50/75	90A20009
22-M-50/75	90A20002

VALVE MODEL	PART NO.
131-M-50/75	90A20004
132-M-50/75	90A20004
131-S-50/75	90A20222
132-S-50/75	90A20036

NCVP131-S-50/75	90A20004
NOVP131-S-50/75	90A20004
VP132-S-50/75	90A20004
3072-C	90A20236

VALVE MODEL	PART NO.
41-S-50/75	90A20223
42-S-50/75	90A20224
41-M-50/75	90A20006
42-M-50/75	90A20015

VP41-S-50/75	90A20006
VP42-S-50/75	90A20006

ASK-5945	90A20052
ASK-5946	90A20052
ASK-594	90A20098

Detroit Line Specifications

- Operating Pressure Range – 28" Mercury Vacuum to 125 PSIG, "VP" Pilot and Air Pilot Require Minimum of 30 PSIG to Shift Spool
- Temperature Range – 40° to 180°F.
For Higher Temperatures Consult Factory
- Viton Seals Standard on All Models
- Explosion Proof Housings Meet – Class I Groups C & D, Class II Groups E, F, & G

Glass Industry Specifications

- Cv = 6.1
- Minimum Pilot Supply: 20 psig
- Maximum Working Pressure: 125 psig
- Temperature Range: 40° to 350° F
- PTFE-impregnated Viton Seals
- Exclusive Thin Lip Seal Design
- Spool Position Indicator Standard
- Minimal Parts for Ease of Maintenance
- Supplied Worldwide through Alkon Distributors
- Lube Port Option Available
- Solenoid Versions with Spool Position Indicators Available
- Single and Dual Pilot Isolation Available
- CV = 6.1 Tested on "ASK" Base

DETROIT LINE

AIR PILOT OPERATED VALVES

Air Pilot operated valves are recommended where it is desirable to substitute pilot air circuitry to replace solenoid operated valves. Typical applications would be where electrically operated valving would present a fire or explosion hazard. With controlled pilot signals air pilot systems have comparable response to electrically operated valves and in many cases system response is enhanced by their use.

SPECIFICATIONS:

Operating Pressure: (Main Valve) vacuum – 150 psig

Pilot Pressure Required: 30 psig

- For Normally Open 3-Way, Supply Port 3

“VP” SERIES SOLENOID PILOT OPERATED

FEATURES:

- Meets all J.I.C. and Industrial standards
- Molded coils are standard
- Fast response and low inrush current
- Rugged cast aluminum design
- High air flow capability
- Delivers millions of trouble free cycles

AVAILABLE IN:

- 2, 3 or 4-Way Models
- Single or Double Solenoid
- Standard Voltages: 120/60Hz, 240/60Hz, 24/60Hz, 12VDC, 24VDC, 120VDC
- Also available with 3-Prong MS Electrical Connector (consult factory)
- External Pilot Provision is field convertible (consult factory)

DIRECT SOLENOID OPERATED

Alkon direct operated solenoid valves are excellent for vacuum or low pressure service or where application demands extremely fast response independent of operating pressure. Complete piping versatility for 3-Way models is also featured.

FEATURES:

- Fast response...Minimum breakdown friction
- Minimum moving parts
- Valves may be mounted in any position
- Inlet and outlet ports may be restricted, plugged or used for alternative pressure arrangements without affecting operation of valve
- All models conform to J.I.C. and industrial standards
- Standard voltage 115/60hz
- For normally open 3-Way, supply port 3

AVAILABLE WITH:

- Single or Double Solenoid
- DC Solenoids (consult factory)
- Base mounting models on 4-Ways
- Manual Override is standard on all models
- Explosion Proof Models – (AC Only) – Add Suffix “X” to end of model number

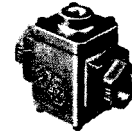

2-Way Line Mounted

3-Way Line Mounted

These 3-Way valves may be used normally open, normally closed, as a selector or directional valve without modification.

4-Way Base Mounted

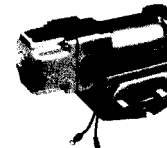
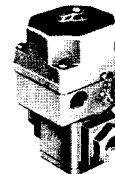
2-Way Line Mounted

3-Way Line Mounted

4-Way Base Mounted

2-Way Line Mounted

3-Way Line Mounted

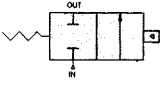
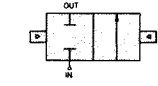
These 3-Way valves may be used normally open, normally closed, as a selector or directional valve without modification.

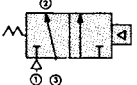
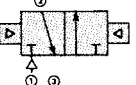

4-Way Base Mounted

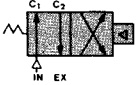
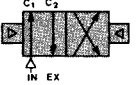

2-Way		Port Size NPTF	Model No.	Dimensions		
				L	H	W
 Single Air Pilot	 Double Air Pilot	Single _____ 1/2	41-M-50	4-1/8	3-3/4	2-1/8
		3/4				
		Double _____ 1/2	41-M-75	4-1/8	3-3/4	2-1/8
		3/4				

3-Way		Port Size NPTF	Model No.	Dimensions		
				L	H	W
 Air Pilot Spring Return	 Double Air Pilot	Single _____ 1/2	131-M-50	4-1/8	4-1/2	3-1/2
		3/4				
		Double _____ 1/2	131-M-75	4-1/8	4-1/2	3-1/2
		3/4				
		Double _____ 1/2	132-M-50	4-1/8	4-1/2	3-1/2
		3/4				
		Double _____ 3/4	132-M-75	4-1/8	4-1/2	3-1/2
		3/4				

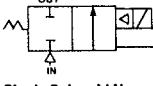
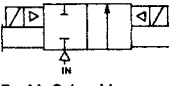
Normally Open = Supply Port 3.

4-Way		Port Size NPTF	Model No.	Dimensions		
				L	H	W
 Air Pilot Spring Return	 Double Air Pilot	Single _____ 1/2	41-M-50	5-3/16	3-1/4	4-1/2
		3/4				
		Double _____ 1/2	41-M-75	6-1/2	3-3/4	4-1/2
		3/4				
		Double _____ 1/2	42-M-50	6-1/2	3-3/4	4-1/2
		3/4				
		Double _____ 3/4	42-M-75	6-1/2	3-3/4	4-1/2
		3/4				

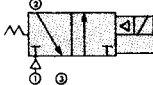
2-Way		Port Size NPTF	Model No.	Dimensions		
				L	H	W
 Single Solenoid Normally Closed Single Solenoid Air Pilot (Maintained Contact)	 Double Solenoid Air Pilot (Momentary Contact)	Single _____ 1/2	*NCVP21-S-50	4-1/8	5-27/32	2-1/2
		3/4				
		Double _____ 1/2	*NCVP21-S-75	4-1/8	5-27/32	2-1/2
		3/4				
		Double _____ 1/2	VP22-S-50	4-1/8	8-27/32	2-1/2
		3/4				
		Double _____ 3/4	VP22-S-75	4-1/8	8-27/32	2-1/2
		3/4				

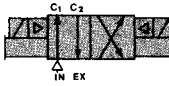

3-Way		Port Size NPTF	Model No.	Dimensions		
				L	H	W
 Single Solenoid Normally Closed Single Solenoid Air Pilot	 Double Solenoid Air Pilot	Single _____ 1/2	*NCVP131-S-50	4-1/8	7	3-5/16
		3/4				
		Double _____ 1/2	*NCVP131-S-75	4-1/8	7	3-5/16
		3/4				
		Double _____ 1/2	VP132-S-50	4-1/8	9-7/16	3-5/16
		3/4				
		Double _____ 3/4	VP132-S-75	4-1/8	9-7/16	3-5/16
		3/4				

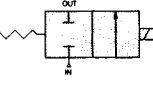
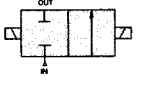
4-Way		Port Size NPTF	Model No.	Dimensions		
				L	H	W
 Single Solenoid Air Pilot (Maintained Contact)	 Double Solenoid Air Pilot (Momentary Contact)	Single _____ 1/2	VP41-S-50S	7-31/32	3-7/8	4-5/16
		3/4				
		Double _____ 1/2	VP41-S-75-S	7-31/32	3-7/8	4-5/16
		3/4				
		Double _____ 1/2	VP42-S-50	10-7/8	3-7/8	4-5/16
		3/4				
		Double _____ 3/4	VP42-S-75	10-7/8	3-7/8	4-5/16
		3/4				

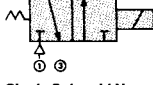
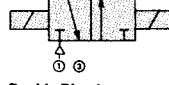
2-Way		Port Size NPTF	Model No.	Dimensions		
				L	H	W
 Single Direct Solenoid (Maintained Contact)	 Double Direct Solenoid (Momentary Contact)	Single _____ 1/2	*NC21-S-50	4-1/8	6-5/16	3-5/16
		3/4				
		Double _____ 1/2	*NC21-S-75	4-1/8	6-5/16	3-5/16
		3/4				
		Double _____ 1/2	22-S-50	4-1/8	9-21/32	3-5/16
		3/4				
		Double _____ 3/4	22-S-75	4-1/8	9-21/32	3-5/16
		3/4				

3-Way		Port Size NPTF	Model No.	Dimensions		
				L	H	W
 Single Solenoid Normally Closed Single Direct Solenoid (Maintained Contact)	 Double Direct Solenoid (Momentary Contact)	Single _____ 1/2	131-S-50	4-1/8	7	3-15/32
		3/4				
		Double _____ 1/2	131-S-75	4-1/8	7	3-15/32
		3/4				
		Double _____ 1/2	132-S-50	4-1/8	10-3/8	3-15/32
		3/4				
		Double _____ 3/4	132-S-75	4-1/8	10-3/8	3-15/32
		3/4				

Normally Open = Supply Port 3.

4-Way		Port Size NPTF	Model No.	Dimensions		
				L	H	W
 Single Direct Solenoid (Maintained Contact)	 Double Direct Solenoid (Momentary Contact)	Single _____ 1/2	41-S-50	8-7/16	4-1/8	4-1/2
		3/4				
		Double _____ 1/2	41-S-75	8-7/16	4-1/8	4-1/2
		3/4				
		Double _____ 1/2	42-S-50	11-13/16	4-1/8	4-1/2
		3/4				
		Double _____ 3/4	42-S-75	11-13/16	4-1/8	4-1/2
		3/4				

DETROIT LINE FOR GLASS INDUSTRY

AIR PILOT OPERATED VALVES

Air pilot operated valves are recommended for applications where the substitution of pilot air circuitry for solenoid operated valves is more suitable.

Controlled pilot signals using pilot air systems show comparable response to electrically operated valves, and in many cases, response is enhanced by their use.

3-way valves may be used normally open, normally closed, or as a selector or directional valve without modification. They are operated with an air pilot signal.

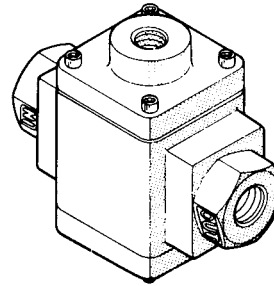

2-Way Line Mounted

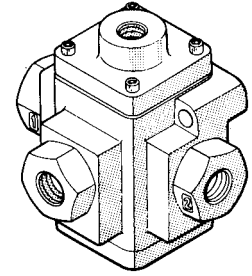

3-Way Line Mounted

ASK594 Valve

The ASK594 Valve was first developed in 1963 for the glass making machine industry. It is basically a 4-Way, air pilot, spring return valve with a visual indicator. The base may be mounted directly on top of a cylinder with porting conforming to the "SK" base interface. The base, exhaust restrictors, and isolation valve are optional. The ASK is the newest version of the same valve.

MODEL #	DESCRIPTION
ASK-594V	Valve on base, no indicator with exhaust restrictors
ASK-5645V	Valve on base, with indicator with exhaust restrictors
ASK-5946V	Valve on base, with indicator without exhaust restrictors

Note: Specify less base, if base is not needed.

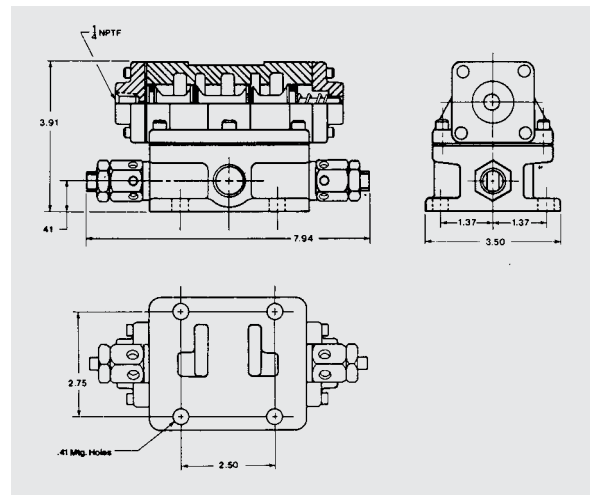

3072-C Isolation Valve

This functional unit easily adapts to the ASK594 valve to provide a quick manual system shutdown. Although the ASK594 normally operates as a 4-Way air piloted valve, by inserting the 3072-C between the air pilot end cap and the valve body, the air pilot signal is blocked to the main valve and the ASK spool returns to a de-energized position.

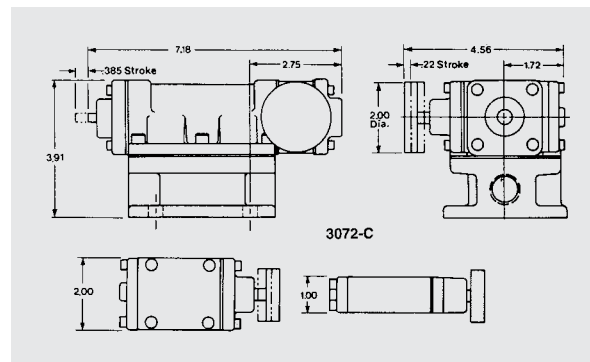

SP-3207 Dual Isolation Valve

Just like the 3072-C, this valve adapts easily to the ASK594 valve to provide a quick manual system shutdown while, at the same time, blocking the signal to another remote valve in the system. This provides a simultaneous isolation of the dual pilots.

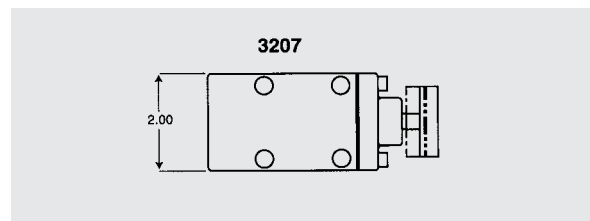





www.alkoncorp.com

Phone 419.333.7000

Fax 419.355.9211

728 Graham Drive

Fremont, OH 43420